

This Page Is Inserted by IFW Operations
and is not a part of the Official Record

BEST AVAILABLE IMAGES

Defective images within this document are accurate representations of the original documents submitted by the applicant.

Defects in the images may include (but are not limited to):

- BLACK BORDERS
- TEXT CUT OFF AT TOP, BOTTOM OR SIDES
- FADED TEXT
- ILLEGIBLE TEXT
- SKEWED/SLANTED IMAGES
- COLORED PHOTOS
- BLACK OR VERY BLACK AND WHITE DARK PHOTOS
- GRAY SCALE DOCUMENTS

IMAGES ARE BEST AVAILABLE COPY.

**As rescanning documents *will not* correct images,
please do not report the images to the
Image Problem Mailbox.**



Control Panel for Generating Vendor-Specific IVS Virtual Kiosks

Configure V.S. Virtual Kiosks | Create V.S. Virtual Kiosks | Modify V.S. Virtual Kiosks | Deploy V.S. Virtual Kiosks | Activate V.S. Virtual Kiosks | Standard Virtual Kiosk Creation

Standard Demonstration Mode

Customize Vendor-Specific Virtual Kiosk

Client Account: DISNEY | Client Account No: 7145001 | User Name: John Smith

Select the Virtual Kiosk you wish to customize by clicking on the Virtual Kiosk Name. When you have finished Customizing the Vendor-Specific Virtual Kiosk click the Next button.

Vendor-Specific Virtual Kiosk Name: Itek@Cycles 2002 | Vendor-Specific Serial Number: 09890-0989

501/1046



FIG. 48M5
http://www.brandkeysystems.com/bk_deliver/m_launch_vendor_create-5.html

file:///E:/www/brandkey/bk_deliver/FMAP7jfs5keja8x.htm



Control Panel for Generating Vendor-Specific (V3) Virtual Kiosks

Configure V/S Virtual Kiosks | Create V/S Virtual Kiosks | Modify V/S Virtual Kiosks | Activate V/S Virtual Kiosks | Deley V/S Virtual Kiosks | Activate V/S Virtual Kiosks

Standard Demonstration Mode

Customer Vendor Specific Virtual Kiosk

Client Account: DISNEY | Client Account No: 7145001 | User Name: John Smith

Customize your Vendor-Specific Virtual Kiosk by selecting the desired Customization Options. Click Preview to preview the appearance of the customized Vendor-Specific Virtual Kiosk. Click Confirm to confirm the changes. Click Cancel to cancel your changes.

Customization Options

Vendor Logo:

Geometric Layout: square

Surface Texture: Black

Surface Color: Black

Button Style Set: square

Button Color Set: Black

Virtual Kiosk

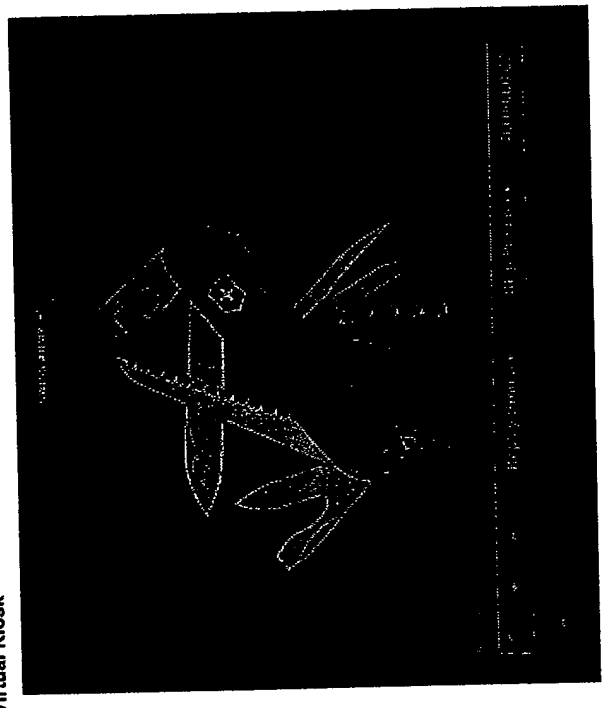

Preview

Cancel

FIG. 48M6

502/1046



503/
1046

FIG. 48 M7



Control Panel for Generating Vendor Specific (V-S) Virtual Kiosks

Configure V-S Virtual Kiosks | Create V-S Virtual Kiosks | Modify V-S Virtual Kiosks | Deploy V-S Virtual Kiosks | Activate V-S Virtual Kiosks

Standard Demonstration Mode

Comment Section for Vendor Specific Virtual Kiosk

Client Account: DISNEY | Client Account No: 7145001 | User Name: John Smith

Congratulations, you have created the following Vendor-Specific Virtual Kiosks, you can now Modify or Deploy these Vendor-Specific Virtual Kiosks.

Vendor-Specific Virtual Kiosk Name	Vendor-Specific Virtual Kiosk Serial Number
Here will go the description of the product.	0900938-78383
Here will go the description of the product.	0900938-78383
Here will go the description of the product.	0900938-78383
Here will go the description of the product.	0900938-78383
Here will go the description of the product.	0900938-78383

4 | 4 Back 1 2 3 4 5 Next | >>

504/1046

FIG. 48M8



Control Panel for Generating Vendor Specific (V S) Virtual Kiosks

Standard Demonstration Mode

Select the Vendor-Specific Virtual Kiosks you wish to modify by clicking on the Virtual Kiosk ID Number.

Virtual Kiosks ID Number	Store Location	Virtual Kiosk Name	Deployed	Active
<u>9909930-00939</u>	Here will go the store location	Virtual Kiosk name	✓	✓
<u>9909930-00939</u>	Here will go the store location	Virtual Kiosk name	✓	✓
<u>9909930-00939</u>	Here will go the store location	Virtual Kiosk name	✓	X
<u>9909930-00939</u>	Here will go the store location	Virtual Kiosk name	✓	✓
<u>9909930-00939</u>	Here will go the store location	Virtual Kiosk name	✓	X

◀ 4 | ◀ Back 1 2 3 4 5 Next ▶▶▶

505/1046

FIG. 48N1



Configure V-S Virtual Kiosks

Create V-S Virtual Kiosks

Modify V-S Virtual Kiosks

Deop. of V-S Virtual Kiosks

Activate V-S Virtual Kiosks

Control Panel for Generating Vendor Branding (V-S) Virtual Kiosks

Standard Demonstration Mode

Client Account: DISNEY

Client Account No: 7145001

User Name: John Smith

Update the information for the selected Virtual Kiosk. Click Update to save your changes. Click Update Brands to update the list of Brand Entities associated with the selected Virtual Kiosk.

Virtual Kiosk Serial Number: 09009876-09

Virtual Kiosk Name:

Display Mode:

Tri-Mode Display comprising: Advertising Spot Display Mode, Promotional Spot Display Mode, and Brand Information Network Display Mode

Dual-Mode Display comprising: Advertising Spot Display Mode, and Brand Information Network Display Mode

Uni-Mode Display comprising: Brand Information Network Display Mode

Allow Consumer Installation:

Yes No

Virtual Kiosk Status:

Deployed-Activated

FIG. 48N2

506 1046



Control Panel for Generating Vendor Specific (V-3) Virtual Kiosks

Configure V-S Virtual Kiosks | Create V-S Virtual Kiosks | Modify V-S Virtual Kiosks | Deploy V-S Virtual Kiosks | Activate V-S Virtual Kiosks

Standard Demonstration Mode

Modify Vendor Specific Virtual Kiosk

Client Account: DISNEY | Client Account No: 7145001 | User Name: John Smith

The Vendor-Specific Virtual Kiosk (Name) has been modified. Please review and confirm your modifications. If any information is not correct then click Edit to correct and update. Click Update Brands to update the list of Brand Entities associated with the selected Virtual Kiosk.

Virtual Kiosk Serial Number: 09009876-09

Virtual Kiosk Name: Virtual Kiosk Name

Virtual Kiosk Mode: Promo-Spot Display Mode

Allow Retailer Installation: Yes

Allow Industrialist Installation: No

Allow Consumer Installation: Yes

Virtual Kiosk Status: Deployed-Activated

5677
1046



FIG. 48N3



Control Panel for Generating Vendor Specific (V-S) Virtual Kiosks

Configure V-S Virtual Kiosks | Create V-S Virtual Kiosks | Modify V-S Virtual Kiosks | Deploy V-S Virtual Kiosks | Activate V-S Virtual Kiosks

Standard Demonstration Mode

Client Account: DISNEY | Client Account No: 7145001 | User Name: John Smith

Please review the list of Brand Entities assigned to the Vendor-Specific Virtual Kiosks. To remove an associated Brand Entity from the Virtual Kiosk, simply uncheck the Active checkbox. To add new Brand Entities to the Virtual Kiosk list, click the Add Brands button. If you do not wish to add any more, click Finish to confirm the Virtual Kiosk Brand Entity list.

Brand Entity Name	Brand Entity Owner	Trade Mark (TM)	Product Descriptor (PD)	Selected
Here will go the Brand Entity	Here will go the Brand Entity Owner	Here will go the trade mark	Here will go the description of the product. Here will go the description of the product.	<input checked="" type="checkbox"/>
Here will go the Brand Entity	Here will go the Brand Entity Owner	Here will go the trade mark	Here will go the description of the product. Here will go the description of the product.	<input checked="" type="checkbox"/>
Here will go the Brand Entity	Here will go the Brand Entity Owner	Here will go the trade mark	Here will go the description of the product. Here will go the description of the product.	<input checked="" type="checkbox"/>
Here will go the Brand Entity	Here will go the Brand Entity Owner	Here will go the trade mark	Here will go the description of the product. Here will go the description of the product.	<input checked="" type="checkbox"/>
Here will go the Brand Entity	Here will go the Brand Entity Owner	Here will go the trade mark	Here will go the description of the product. Here will go the description of the product.	<input checked="" type="checkbox"/>

4 | < Back 1 2 3 4 5 Next > | ▶▶

Add Brand Finish

FIG. 48N4

508/1046



Control Panel for Generating Vendor Specific (V-S) Virtual Kiosks

Configure V-S Virtual Kiosks | Create V-S Virtual Kiosks | Modify V-S Virtual Kiosks | Deploy V-S Virtual Kiosks | Activate V-S Virtual Kiosks

[Search for Brand Entity](#)

Standard Demonstration Mode

Client Account: DISNEY | Client Account No: 7145001 | User Name: John Smith

Search for the Brand Entities to add to the Vendor-Specific Virtual Kiosks. You may search by the Trade Mark, Product Descriptor or Brand Entity Name. Enter the search criteria in the textbox, select the parameters from the dropdown list and click the Search button to initiate the Brand Entity search.

Search for:

By: Trademark

500/1046

FIG. 48N5



Control Panel for Generating Vendor Specific (V-S) Virtual Kiosks

Configure V-S Virtual Kiosks | Create V-S Virtual Kiosks | Modify V-S Virtual Kiosks | Deploy V-S Virtual Kiosks | Activate V-S Virtual Kiosks

Standard Demonstration Mode

Client Account: DISNEY | Client Account No: 7145001 | User Name: John Smith

Select the Brand Entities to add to the Vendor-Specific Virtual Kiosks.

Brand Entity Name	Brand Entity Owner	Trade Mark (TM)	Product Descriptor (PD)	Add to Kiosk
Here will go the Brand Entity	Here will go the Brand Entity Owner	Here will go the trade mark	Here will go the description of the product. Here will go the description of the product.	<input type="checkbox"/>
Here will go the Brand Entity	Here will go the Brand Entity Owner	Here will go the trade mark	Here will go the description of the product. Here will go the description of the product.	<input type="checkbox"/>
Here will go the Brand Entity	Here will go the Brand Entity Owner	Here will go the trade mark	Here will go the description of the product. Here will go the description of the product.	<input type="checkbox"/>
Here will go the Brand Entity	Here will go the Brand Entity Owner	Here will go the trade mark	Here will go the description of the product. Here will go the description of the product.	<input type="checkbox"/>
Here will go the Brand Entity	Here will go the Brand Entity Owner	Here will go the trade mark	Here will go the description of the product. Here will go the description of the product.	<input type="checkbox"/>

44 | Back | 1 2 3 4 5 | Next | >>



FIG. 48N7

515/1046



Control Panel for Generating Vendor Specific (V-S) Virtual Kiosks

Configure V-S Virtual Kiosks | Create V-S Virtual Kiosks | Modify V-S Virtual Kiosks | Deploy V-S Virtual Kiosks | Activate V-S Virtual Kiosks

Standard Demonstration Mode

Client Account: DISNEY | Client Account No: 7145001 | User Name: John Smith

Vendor-Specific Virtual Kiosk has been modified. Please review and confirm the information below. If any information is not correct then click Edit to correct and update.

Name: Name goes here
ID: 0944930-9388399
Mode: Ad-Spot Display Mode

Table with 4 columns: Brand Entity Name, Brand Entity Owner, Trade Mark (TM), Product Descriptor (PD). Each row contains placeholder text: 'Here will go the Brand Entity Owner/Trade Mark/Product Descriptor'.

Navigation buttons: Back, 1, 2, 3, 4, 5, Next



FIG. 48N8

511/1046



Control Panel for Generating Vendor Specific (V-S) Virtual Kiosks

Configure V-S Virtual Kiosks | Create V-S Virtual Kiosks | Modify V-S Virtual Kiosks | Deploy V-S Virtual Kiosks | Activate V-S Virtual Kiosks

Standard Demonstration Mode

Selected Environment

Client Account: DISNEY | Client Account No: 7145001 | User Name: John Smith

Vendor-Specific Virtual Kiosk can be Deployed to Launch from one of four different Environments:

- An HTML-Encoded Brandkey(TM) Button for launching the Vendor-Specific Virtual Kiosk from any web page once the Brandkey(TM) Button and its accompanying Virtual Kiosk Tag have been installed in the page.
- An HTML-Encoded Document for launching the Vendor-Specific Virtual Kiosk from a Word or PDF Document once the Document containing its Virtual Kiosk Tag have been downloaded.
- An HTML-Encoded Image for launching the Vendor-Specific Virtual Kiosk from any web page once the Image and its accompanying Virtual Kiosk Tag have been installed in the page.
- An HTML-Encoded Desktop Icon for launching the Vendor-Specific Virtual Kiosk from any Computer Desktop once the Desktop Icon containing its Virtual Kiosk Tag has been installed on the Computer Desktop.

Select the Environment from which the selected Vendor-Specific Virtual Kiosks will be launched:

- HTML-Encoded Brandkey (TM) Button
- HTML-Encoded Document
- HTML-Encoded Image
- HTML-Encoded Desktop Icon

FIG. 4801

5/7/2003



Control Panel for Generating Vendor Specific (V-S) Virtual Kiosks

Configure V-S Virtual Kiosks | Create V-S Virtual Kiosks | Modify V-S Virtual Kiosks | Deploy V-S Virtual Kiosks | Activate V-S Virtual Kiosks

Standard Demonstration Mode

Client Account: DISNEY | Client Account No: 7145001 | User Name: John Smith

Select the Vendor-Specific Virtual Kiosk(s) you wish to deploy.

Virtual Kiosk ID	Vendor-Specific Virtual Kiosk Name	Deploy
9909930-00939	Here will go the description of the retailer.	<input type="radio"/>
9909930-00939	Here will go the description of the retailer.	<input type="radio"/>
9909930-00939	Here will go the description of the retailer.	<input type="radio"/>
9909930-00939	Here will go the description of the retailer.	<input type="radio"/>
9909930-00939	Here will go the description of the retailer.	<input type="radio"/>

44 | < Back 1 2 3 4 5 Next > | >>

Back Next

FIG. 4802

519/1046



Control Panel for Generating Vendor-Specific (V-S) Virtual Kiosks

Configure V-S Virtual Kiosks | Create V-S Virtual Kiosks | Modify V-S Virtual Kiosks | Activate V-S Virtual Kiosks

Standard Demonstration Mode

Client Account: DISNEY | Client Account No: 7145001 | User Name: John Smith

Select the languages in which you wish to deploy the configured Virtual Kiosks.

Language	Selected	Language	Selected
English	<input type="checkbox"/>	Austrian	<input checked="" type="checkbox"/>
Spanish	<input checked="" type="checkbox"/>	Brazilian	<input checked="" type="checkbox"/>
French	<input checked="" type="checkbox"/>	Canadian French	<input checked="" type="checkbox"/>
German	<input checked="" type="checkbox"/>	Catalan	<input checked="" type="checkbox"/>
Japanese	<input checked="" type="checkbox"/>	Finnish	<input checked="" type="checkbox"/>
Dutch	<input checked="" type="checkbox"/>	Norwegian	<input checked="" type="checkbox"/>
Italian	<input checked="" type="checkbox"/>	Portuguese	<input checked="" type="checkbox"/>
Chinese	<input checked="" type="checkbox"/>	Swedish	<input checked="" type="checkbox"/>
Danish	<input checked="" type="checkbox"/>		



FIG 4803A

514/1046



Control Panel for Generating Vendor-Specific (V-S) Virtual Kiosks

Configure V-S Virtual Kiosks | Create V-S Virtual Kiosks | Modify V-S Virtual Kiosks | Deploy V-S Virtual Kiosks | Activate V-S Virtual Kiosks

Standard Demonstration Mode

Create HTML Embedded Document

Client Account: DISNEY | Client Account No: 7145001 | User Name: John Smith

Creates or imports the document into which you wish to embed the Vendor-Specific Virtual Kiosk tag. Click the Import button to load an existing document. The document must be in World format to load correctly.

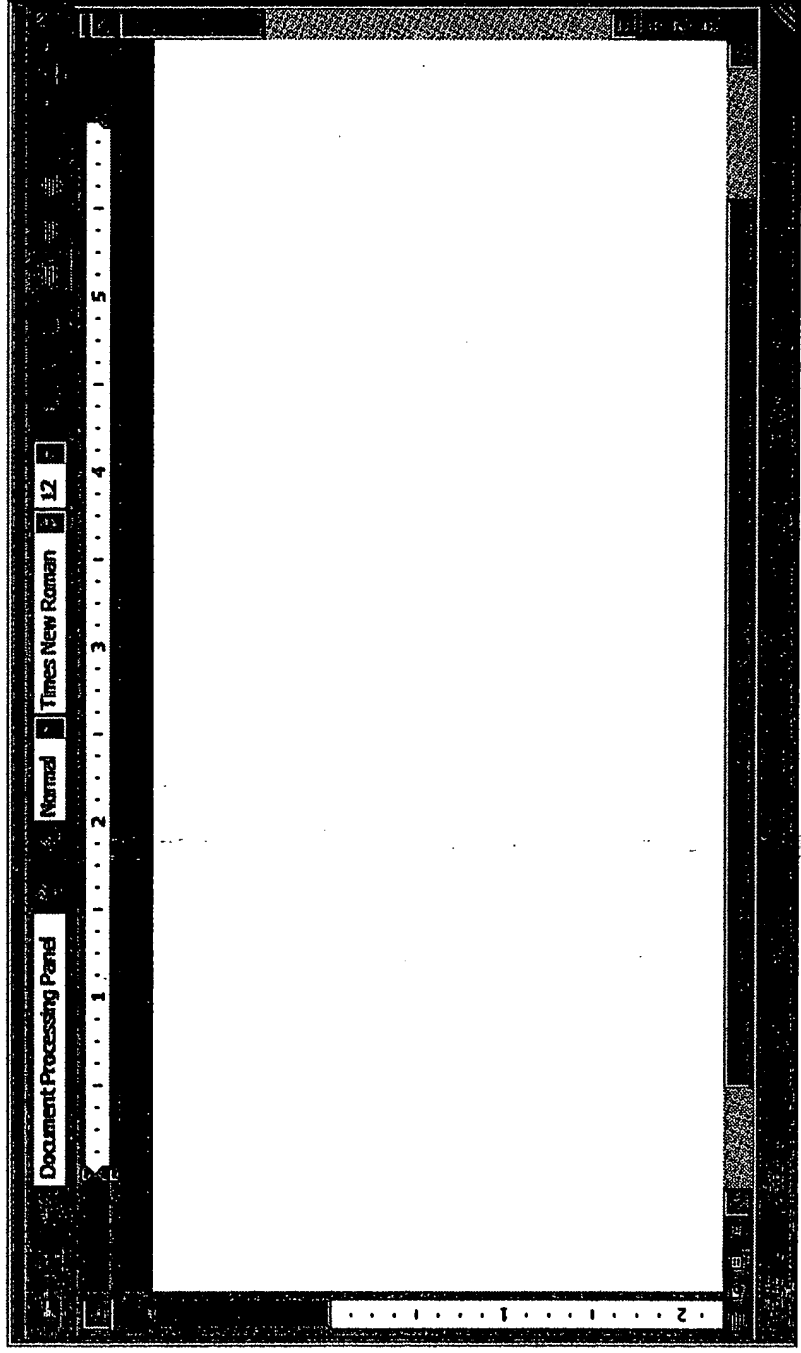

FIG. 480BB

595/1046



526/1046

FIG. 4803C



Control Panel for Generating Vendor Specific (V-S) Virtual Kiosks

Configure V-S Virtual Kiosks | Create V-S Virtual Kiosks | Modify V-S Virtual Kiosks | Deploy V-S Virtual Kiosks | Activate V-S Virtual Kiosks

Standard Demonstration Mode

Client Account: DISNEY | Client Account No: 7145001 | User Name: John Smith

The HTML-Embedded document has been saved. Please select the format of the HTML-Embedded document you wish to deploy to the Brandkey Systems Web Server.

- Microsoft Word Document format
- Adobe PDF Document format

5/17/10/16

Back Next

FIG. 4803D



Control Panel for Generating Vendor Specific (V-S) Virtual Kiosks

Configure V-S Virtual Kiosks | Create V-S Virtual Kiosks | Modify V-S Virtual Kiosks | Deploy V-S Virtual Kiosks | Activate V-S Virtual Kiosks

Standard Demonstration Mode

Client Account: DISNEY | Client Account No: 7145001 | User Name: John Smith

Select the Vendor-Specific Virtual Kiosk(s) you wish to deploy.

Virtual Kiosk ID	Vendor-Specific Virtual Kiosk Name	Deploy
9909930-00939	Here will go the description of the retailer.	<input type="radio"/>
9909930-00939	Here will go the description of the retailer.	<input type="radio"/>
9909930-00939	Here will go the description of the retailer.	<input type="radio"/>
9909930-00939	Here will go the description of the retailer.	<input type="radio"/>
9909930-00939	Here will go the description of the retailer.	<input type="radio"/>

44 | 4 Back 1 2 3 4 5 Next | >>



FIG. 4803E

588/1046



Control Panel for Generating Vendor-Specific (V-S) Virtual Kiosks

Configure V-S Virtual Kiosks | Create V-S Virtual Kiosks | Modify V-S Virtual Kiosks | Activate V-S Virtual Kiosks

Standard Demonstration Mode

Client Account: DISNEY

Client Account No: 7145001

User Name: John Smith

Select the languages in which you wish to deploy the configured Virtual Kiosks.

- Language
- English
- Spanish
- French
- German
- Japanese
- Dutch
- Italian
- Chinese
- Danish

- Selected
-
-
-
-
-
-
-
-
-

- Language
- Austrian
- Brazilian
- Canadian French
- Catalan
- Finnish
- Norwegian
- Portuguese
- Swedish

- Selected
-
-
-
-
-
-
-
-

Back Next

FIG. 4803F

519/1046



Control Panel for Generating Vendor Specific IVS Virtual Kiosks

Configure V.S. Virtual Kiosks | Create V.S. Virtual Kiosks | Modify V.S. Virtual Kiosks | Deploy V.S. Virtual Kiosks | Activate V.S. Virtual Kiosks

Standard Demonstration Mode

Client Account: DISNEY | Client Account No: 7145001 | User Name: John Smith

Select the image to upload that you wish to use as the base image for the HTML-Encoded Image you wish to create.

Base Image:

Select the image to upload that you wish to use as the secondary image to place on top of the base image for the HTML-Encoded Image you wish to create.

Secondary Image:



FIG. 48039

520 / 1046



Control Panel for Generating Vendor Specific (V-S) Virtual Kiosks

Configure V-S Virtual Kiosks | Create V-S Virtual Kiosks | Modify V-S Virtual Kiosks | Deploy V-S Virtual Kiosks | Activate V-S Virtual Kiosks

Standard Demonstration Mode

Client Account: DISNEY | Client Account No: 7145001 | User Name: John Smith

Use the window below to format your new image which shall be used in the HTML-Encoded Image you wish to create. You may resize both the images if you wish. The Secondary image shall always appear on top of the Base Image.

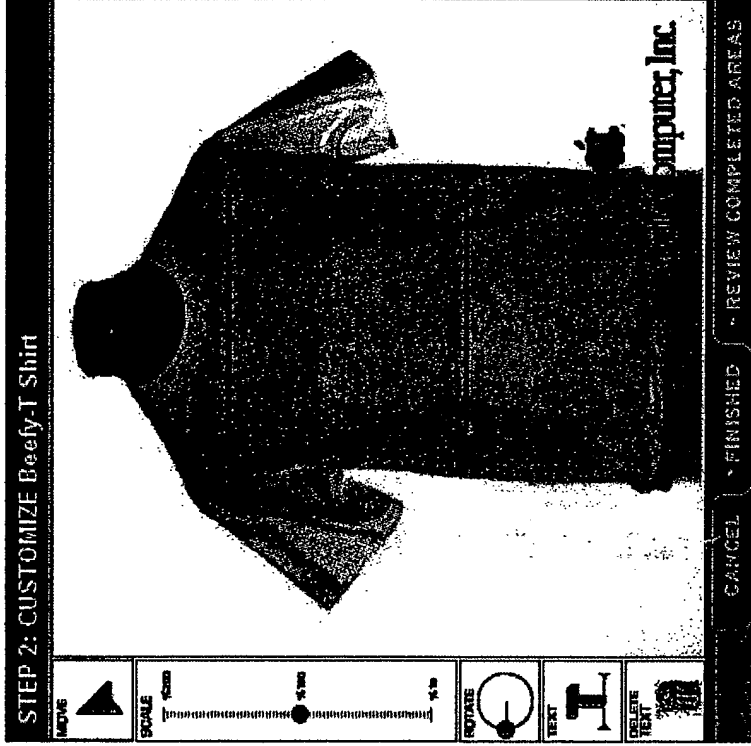

FIG. 4803H

521/1046



522/1046

FIG. 4803I



Control Panel for Generating Vendor Specific (V-S) Virtual Kiosks

Configure V-S Virtual Kiosks | Create V-S Virtual Kiosks | Modify V-S Virtual Kiosks | Deploy V-S Virtual Kiosks | Activate V-S Virtual Kiosks

Standard Demonstration Mode

Client Account: DISNEY | Client Account No: 7145001 | User Name: John Smith

The image you created is shown below. Please specify the area over which the consumer will click to launch the Vendor-Specific Virtual Kiosk.

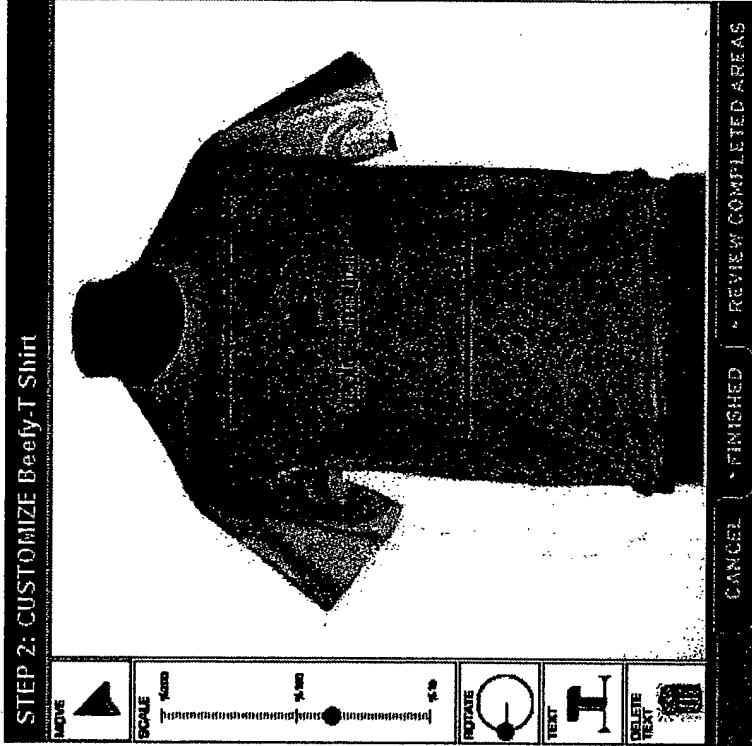

523/1046

FIG. 4803T



524/1046

FIG. 4803K



Configure V-S Virtual Kiosks

Create V-S Virtual Kiosks

Modify V-S Virtual Kiosks

Deploy V-S Virtual Kiosks

Activate V-S Virtual Kiosks

Control Panel for Generating Vendor Specific (V-S) Virtual Kiosks

Standard Demonstration Mode

Select Vendor Specific Virtual Kiosk(s)

Client Account: DISNEY | Client Account No: 7145001 | User Name: John Smith

Select the Vendor-Specific Virtual Kiosk(s) you wish to deploy.

Virtual Kiosk ID	Vendor-Specific Virtual Kiosk Name	Deploy
9909930-00939	Here will go the description of the retailer.	<input type="radio"/>
9909930-00939	Here will go the description of the retailer.	<input type="radio"/>
9909930-00939	Here will go the description of the retailer.	<input type="radio"/>
9909930-00939	Here will go the description of the retailer.	<input type="radio"/>
9909930-00939	Here will go the description of the retailer.	<input type="radio"/>

44 | Back 1 2 3 4 5 Next >>>



FIG. 4803L

525/1046

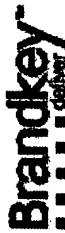

Control Panel for Generating Vendor Specifics (V-S) Virtual Kiosks

Configure V-S Virtual Kiosks | Create V-S Virtual Kiosks | Modify V-S Virtual Kiosks | Activate V-S Virtual Kiosks

Standard Demonstration Mode

Client Account: DISNEY | Client Account No: 7145001 | User Name: John Smith

Select the languages in which you wish to deploy the configured Virtual Kiosks.

Language	Selected	Language	Selected
English	<input type="checkbox"/>	Austrian	<input type="checkbox"/>
Spanish	<input checked="" type="checkbox"/>	Brazilian	<input checked="" type="checkbox"/>
French	<input checked="" type="checkbox"/>	Canadian French	<input checked="" type="checkbox"/>
German	<input checked="" type="checkbox"/>	Catalan	<input checked="" type="checkbox"/>
Japanese	<input checked="" type="checkbox"/>	Finnish	<input checked="" type="checkbox"/>
Dutch	<input checked="" type="checkbox"/>	Norwegian	<input checked="" type="checkbox"/>
Italian	<input checked="" type="checkbox"/>	Portuguese	<input checked="" type="checkbox"/>
Chinese	<input checked="" type="checkbox"/>	Swedish	<input checked="" type="checkbox"/>
Danish	<input checked="" type="checkbox"/>		



FIG. 4803M

526/1046



Control Panel for Generating Vendor Specific (V-S) Virtual Kiosks

Configure V-S Virtual Kiosk | Create V-S Virtual Kiosks | Modify V-S Virtual Kiosks | Deploy V-S Virtual Kiosks | Activate V-S Virtual Kiosks

Standard Demonstration Mode

Client Account: DISNEY | Client Account No: 7145001 | User Name: John Smith

Please Upload the image you wish to use as the icon for the HTML-Encoded icon you wish to deploy.

Icon Image:

Back Next

FIG. 4803N

527/1046



Control Panel for Generating Vendor-Specific (V-S) Virtual Kiosks

Configure V-S Virtual Kiosk | Create V-S Virtual Kiosks | Modify V-S Virtual Kiosks | Deploy V-S Virtual Kiosks | Activate V-S Virtual Kiosks

Standard Demonstration Mode

Generating Deployment of the Vendor-Specific Virtual Kiosks

Client Account: DISNEY | Client Account No: 7145001 | User Name: John Smith

The selected Vendor-Specific Virtual Kiosks have now been Deployed in the selected Launch Environment. To prepare the Deployed Vendor-Specific Virtual Kiosks for Installation, you must first Activate them:

529/1046

FIG. 4805



Control Panel for Generating Vendor Specific (V-S) Virtual Kiosks

Configure V-S Virtual Kiosks | Create V-S Virtual Kiosks | Modify V-S Virtual Kiosks | Deploy V-S Virtual Kiosks | Activate V-S Virtual Kiosks

Standard Demonstration Mode

Client Account: DISNEY | Client Account No: 7145001 | User Name: John Smith

The Virtual Kiosks below have been deployed. You can activate any of the Virtual Kiosk by checking the Active field for that Virtual Kiosk. To deactivate any Virtual Kiosk simply uncheck the Active field for the Virtual Kiosk. Click Update to save the changes.

Virtual Kiosk ID	Virtual Kiosk Name	Active
Here will go the min	Here will go the product name	<input checked="" type="checkbox"/>
Here will go the min	Here will go the product name	<input type="checkbox"/>
Here will go the min	Here will go the product name	<input type="checkbox"/>
Here will go the min	Here will go the product name	<input type="checkbox"/>
Here will go the min	Here will go the product name	<input type="checkbox"/>

« | « Back 1 2 3 4 5 6 7 8 9 10 Next » | »



FIG. 48 P1

530/1046



Control Panel for Generating Service Provider Specific (S.P.S) Virtual Kiosks

Configure S-P-S Virtual Kiosks | Create S-P-S Virtual Kiosks | Modify S-P-S Virtual Kiosks | Deploy S-P-S Virtual Kiosks | Activate S-P-S Virtual Kiosks

Standard Demonstration Mode

Control Panel for Generating Service Provider Specific (S.P.S) Virtual Kiosks

Client Account: DISNEY | Client Account No: 7145001 | User Name: John Smith

Text: Rt.139

531/10416

FIG. 4801



Control Panel for Generating Service-Provider Specific (S-P-S) Virtual Kiosks

Configure S-P-S Virtual Kiosks | Create S-P-S Virtual Kiosks | Modify S-P-S Virtual Kiosks | Deploy S-P-S Virtual Kiosks | Activate S-P-S Virtual Kiosks

Standard Demonstration Mode

Service-Provider Configuration

Client Account: DISNEY | Client Account No: 7145001 | User Name: John Smith

Do you wish to create a Service-Provider-Specific Virtual Kiosk for all registered Brands?

- Yes
- No

Do you wish to allow for creation of custom Service-Provider-Specific Virtual Kiosks?

- Yes
- No

By default do you wish to allow installation of Service-Provider-Specific Virtual Kiosks by Consumers?

- Yes
- No

532/1046



FIG. 4802



Control Panel for Generating Service Provider Specific (S-P-S) Virtual Kiosks

Configure S-P-S Virtual Kiosks | Create S-P-S Virtual Kiosks | Modify S-P-S Virtual Kiosks | Deo by S-P-S Virtual Kiosks | Activate S-P-S Virtual Kiosks

Standard Demonstration Mode

Client Account: DISNEY | Client Account No: 7145001 | User Name: John Smith

You have selected to allow the following Retailers to install Service-Provider-Specific Virtual Kiosks you create. If you wish to remove a Retailer from this list, then uncheck the Active checkbox next to their name. Click Next to save your changes. Click Add Retailers to add additional Retailers to this list.

Retailer Name	City	State	Zip/Postal Code	Country	Active
Retailer Name 1	City 1	State 1	Zip/Postal Code 1	Country 1	<input type="checkbox"/>
Retailer Name 2	City 2	State 2	Zip/Postal Code 2	Country 2	<input type="checkbox"/>
Retailer Name 3	City 3	State 3	Zip/Postal Code 3	Country 3	<input type="checkbox"/>
Retailer Name 4	City 4	State 4	Zip/Postal Code 4	Country 4	<input type="checkbox"/>
Retailer Name 5	City 5	State 5	Zip/Postal Code 5	Country 5	<input type="checkbox"/>

Back 1 2 3 4 5 Next

Back Add Retailers Next

FIG. 4803

533/1046



Control Panel for Generating Service-Provider-Specific (S-P-S) Virtual Kiosks

Configure S-P-S Virtual Kiosks | Create S-P-S Virtual Kiosks | Modify S-P-S Virtual Kiosks | Activate S-P-S Virtual Kiosks

Standard Demonstration Mode

Search for Retailers

Client Account: DISNEY | Client Account No: 7145001 | User Name: John Smith

Search for the Retailers you wish to add to the list of Retailers allowed to install Service-Provider-Specific Virtual Kiosks. You can search by Name, City, State, Zip/Postal Code and Country. Click Search to initiate the retailer search.

Retailer Name:

City:

State:

Zip/Postal Code:

Country:

539/1046



FIG. 4804

Control Panel for Shopping Service Provider Specific (S.P.S) Virtual Kiosks



Configure S.P.S Virtual Kiosks | Create S.P.S Virtual Kiosks | Modify S.P.S Virtual Kiosks | Deploy S.P.S Virtual Kiosks | Activate S.P.S Virtual Kiosks

Standard Demonstration Mode

Client Account: DISNEY | Client Account No: 7145001 | User Name: John Smith

The following Retailers matched your search criteria. Check the Add Retailer to add the Retailer to the list of Retailers allowed to install your Service-Provider-Specific Virtual Kiosks. Click Next to save your changes. Click Back to redo your search.

Retailer Name	City	State	Zip/Postal Code	Country	Add Retailer
Retailer Name	Norwalk	Connecticut	06903	United States	<input type="checkbox"/>
Retailer Name	Stamford	Connecticut	06903	United States	<input type="checkbox"/>
Retailer Name	New York	New York	06903	United States	<input type="checkbox"/>
Retailer Name	Norwalk	Connecticut	06903	United States	<input type="checkbox"/>
Retailer Name	Stamford	Connecticut	06903	United States	<input type="checkbox"/>

535/1046

4 | < Back 1 2 3 4 5 Next > | >>

Back Next

FIG. 4805



Control Panel for Generating Service-Provider Specific (S-P-S) Virtual Kiosks

Configure S-P-S Virtual Kiosks | Create S-P-S Virtual Kiosks | Modify S-P-S Virtual Kiosks | Deactivate S-P-S Virtual Kiosks | Activate S-P-S Virtual Kiosks

Standard Demonstration Mode

Client Account: DISNEY | Client Account No: 7145001 | User Name: John Smith

You have selected to allow the following Industrialists to install Service-Provider-Specific Virtual Kiosks you create. If you wish to remove an Industrialist from this list, then uncheck the Active checkbox next to their name. Click Next to save your changes. Click Add Industrialists to add additional Industrialists to this list.

Industrialist Name	City	State	Zip/Postal Code	Country	Active
Industrialist Name 1	City 1	State 1	Zip/Postal Code 1	Country 1	<input type="checkbox"/>
Industrialist Name 2	City 2	State 2	Zip/Postal Code 2	Country 2	<input type="checkbox"/>
Industrialist Name 3	City 3	State 3	Zip/Postal Code 3	Country 3	<input type="checkbox"/>
Industrialist Name 4	City 4	State 4	Zip/Postal Code 4	Country 4	<input type="checkbox"/>
Industrialist Name 5	City 5	State 5	Zip/Postal Code 5	Country 5	<input type="checkbox"/>

« | « Back 1 2 3 4 5 Next » | »

Back Add Industrialist Next

FIG. 48Q6

536/1046



Control Panel for Generating Service-Provider Specific (S-P-S) Virtual Kiosks

Configure S-P-S Virtual Kiosks | Create S-P-S Virtual Kiosks | Modify S-P-S Virtual Kiosks | Dea by S-P-S Virtual Kiosks | Activate S-P-S Virtual Kiosks

Standard Demonstration Mode

[Search for Industrialists](#)

Client Account: DISNEY | Client Account No: 7145001 | User Name: John Smith

Search for the Industrialists you wish to add to the list of Industrialists allowed to install Service-Provider-Specific Virtual Kiosks. You can search by Name, City, State, Zip/Postal Code and Country. Click Search to initiate the Industrialist search.

Industrialist Name:

City:

State:

Zip/Postal Code:

Country:

537/1046

FIG.4807



Control Panel for Generating Service-Provider Specific (S-P-S) Virtual Kiosks

Configure S-P-S Virtual Kiosks | Create S-P-S Virtual Kiosks | Modify S-P-S Virtual Kiosks | Deploy S-P-S Virtual Kiosks | Activate S-P-S Virtual Kiosks

Standard Demonstration Mode

Client Account: DISNEY | Client Account No: 7145001 | User Name: John Smith

The following Industrialists matched your search criteria. Check the Add Industrialist to add the Industrialist to the list of Industrialists allowed to install your Service-Provider-Specific Virtual Kiosks. Click Next to save your changes. Click Back to redo your search.

Industrialist Name	City	State	Zip/Postal Code	Country	Add Industrialist
Industrialist Name	Norwalk	Connecticut	06903	United States	<input type="checkbox"/>
Industrialist Name	Stamford	Connecticut	06903	United States	<input type="checkbox"/>
Industrialist Name	New York	New York	06903	United States	<input type="checkbox"/>
Industrialist Name	Norwalk	Connecticut	06903	United States	<input type="checkbox"/>
Industrialist Name	Stamford	Connecticut	06903	United States	<input type="checkbox"/>

« | « Back 1 2 3 4 5 Next » | »

Back Next

FIG. 4808

538/1046



Control Panel for Generating Service Provider Specific (S.P.S) Virtual Kiosks

Configure S.P.S Virtual Kiosks | Create S.P.S Virtual Kiosks | Modify S.P.S Virtual Kiosks | Deploy S.P.S Virtual Kiosks | Activate S.P.S Virtual Kiosks

Standard Demonstration Mode

Client Account: DISNEY | Client Account No: 7145001 | User Name: John Smith

You have chosen to Forbid the following Domains from launching your Service-Provider-Specific Virtual Kiosks. If you wish to remove a Domain from the list, uncheck the Forbidden checkbox. Click Next to save your changes. Click Add Domain to add another Domain to the Forbidden Domains List.

Domain Name	Forbidden
Domain Name 1	<input checked="" type="checkbox"/>
Domain Name 2	<input checked="" type="checkbox"/>
Domain Name 3	<input checked="" type="checkbox"/>
Domain Name 4	<input checked="" type="checkbox"/>
Domain Name 5	<input checked="" type="checkbox"/>

Back 12345 Next

Back Add Domain Edit

FIG. 48 Q9

539/1046



Control Panel for Generating Service Provider Specific (S-P-S) Virtual Kiosks

Configure S-P-S Virtual Kiosks | Create S-P-S Virtual Kiosks | Modify S-P-S Virtual Kiosks | Deploy S-P-S Virtual Kiosks | Activate S-P-S Virtual Kiosks

Standard Demonstration Mode

FOR DEMONSTRATION ONLY

Client Account: DISNEY | Client Account No: 7145001 | User Name: John Smith

Enter the Root Domain Name you wish to add to the Forbidden Domain List and click Next to save it to the list. The Root Domain name is the basic Domain Name of the site you wish to block, e.g.: www.mystore.com.

Root Domain Name:

540/1046

Back Next

FIG. 48010



Control Panel for Generating Service-Provider-Specific (S.P.S) Virtual Kiosks

Configure S.P-S Virtual Kiosks | Create S.P-S Virtual Kiosks | Modify S.P-S Virtual Kiosks | Deo by S.P-S Virtual Kiosks | Activate S.P-S Virtual Kiosks

Standard Demonstration Mode

Client Account: DISNEY | Client Account No: 7145001 | User Name: John Smith

Please select the display mode that will be assigned to the Service-Provider-Specific Virtual Kiosks you will be creating in this section:

- Tri-Mode Display featuring Promotional Spots + Advertising Spots + the Brand Information Network
- Dual-Mode Display featuring Advertising Spots + the Brand Information Network
- Single-Mode Display featuring the Brand Information Network



FIG. 48R1

540/1046



Control Panel for Generating Service-Provider Specific (S-P-S) Virtual Kiosks

Configure S-P-S Virtual Kiosks | Create S-P-S Virtual Kiosks | Modify S-P-S Virtual Kiosks | Deploy S-P-S Virtual Kiosks | Activate S-P-S Virtual Kiosks
S-P-S Virtual Kiosks | Display Virtual Kiosks | Add Virtual Kiosks | Remove Virtual Kiosks | Search for Brand Entities | Confirm Virtual Kiosks

Standard Demonstration Mode

Search for Brand Entities

Client Account: DISNEY | Client Account No: 7145001 | User Name: John Smith

Search for the Brand Entities to add to the Service-Provider-Specific Virtual Kiosk. The Products associated with the selected Brand Entities will appear in the Service-Provider-Specific Virtual Kiosk. You may search by the Service Mark, Service Descriptor or Brand Entity Name. Enter the search criteria in the textbox, select the parameters from the dropdown list, and click the Search button to initiate the Brand Entity Search.

Search Criteria:

By: Service Mark

Back Search

FIG. 48 R2

598/1046



Control Panel for Generating Service Provider Specific (S.P.S) Virtual Kiosks

Configure S.P.S Virtual Kiosks | Create S.P.S Virtual Kiosks | Modify S.P.S Virtual Kiosks | Deactivate S.P.S Virtual Kiosks | Activate S.P.S Virtual Kiosks

Standard Demonstration Mode

Client Account: DISNEY | Client Account No: 7145001 | User Name: John Smith

Select the Brand Entities to add to the Vendor-Specific Virtual Kiosks.

Brand Entity	Brand Entity Owner	Service Mark	Product Descriptor	No. of Services	Add to Kiosk
Here will go the brand entity	Here will go the brand owner	Here will go the service mark	Here will go the service name	Here will go the No. of services	<input type="checkbox"/>
Here will go the brand entity	Here will go the brand owner	Here will go the service mark	Here will go the service name	Here will go the No. of services	<input type="checkbox"/>
Here will go the brand entity	Here will go the brand owner	Here will go the service mark	Here will go the service name	Here will go the No. of services	<input type="checkbox"/>
Here will go the brand entity	Here will go the brand owner	Here will go the service mark	Here will go the service name	Here will go the No. of services	<input type="checkbox"/>
Here will go the brand entity	Here will go the brand owner	Here will go the service mark	Here will go the service name	Here will go the No. of services	<input type="checkbox"/>

543/1046

Back 1 2 3 4 5 Next



FIG. 48R3



Control Panel for Controlling Service-Provider Specific (S.P.S.) Virtual Kiosks

Configure S.P.S. Virtual Kiosks | Create S.P.S. Virtual Kiosks | Modify S.P.S. Virtual Kiosks | Deactivate S.P.S. Virtual Kiosks | Activate S.P.S. Virtual Kiosks

Standard Demonstration Mode

Name: Service-Provider-Specific Virtual Kiosk

Client Account: DISNEY | Client Account No: 7145001 | User Name: John Smith

Name the Service-Provider-Specific Virtual Kiosk you have just created.

Virtual Kiosk ID	Service Provider	Virtual Kiosk Name
Here will go the virtual kiosk ID	Here will go the service-provider	<input type="text"/>

◀◀ | ◀ Back 1 2 3 4 5 Next ▶▶

544/1046



FIG. 48R4



Control Panel for Generating Service-Provider-Specific (S.P.S) Virtual Kiosks

Configure S.P.S Virtual Kiosks | Create S.P.S Virtual Kiosks | Modify S.P.S Virtual Kiosks | Deploy S.P.S Virtual Kiosks | Activate S.P.S Virtual Kiosks
Get Virtual Kiosk Display Images | Select a Service-Provider | View Virtual Kiosk | Customizing Virtual Kiosk

Standard Demonstration Mode

Customize Service-Provider-Specific Virtual Kiosk

Client Account: DISNEY | Client Account No: 7145001 | User Name: John Smith

Select the Virtual Kiosk you wish to customize by clicking on the Virtual Kiosk Name. When you have finished Customizing the Service-Provider-Specific Virtual Kiosk click the Next button.

Service-Provider-Specific Virtual Kiosk Name | Service-Provider-Specific Serial Number
Trek@Cycles 2002 | 09890-0989

545/1046

FIG. 48R5
http://www.brandkeysystems.com/bk_deliver/m_launch-service-provider_create-5.html





Control Panel for Generating Service-Provider-Specific (S.P.S.) Virtual Kiosks

Standard Demonstration Mode

Client Account: DISNEY | Client Account No: 7145001 | User Name: John Smith

Customize your Service-Provider-Specific Virtual Kiosk by selecting the desired Customization Options. Click Preview to preview the appearance of the customized Service-Provider-Specific Virtual Kiosk. Click Confirm to confirm the changes. Click Cancel to cancel your changes.

Customization Options

Service-Provider Logo: [input field]

Geometric Layout: square

Surface Texture: Black

Surface Color: Black

Button Style Set: square

Button Color Set: Black

Virtual Kiosk



FIG. 48 R6

596/1046



597/1046

FIG. 48R7



Control Panel for Generating Service-Provider Specific (S P-S) Virtual Kiosks

Configure S-P-S Virtual Kiosks | Create S-P-S Virtual Kiosks | Modify S-P-S Virtual Kiosks | Deploy S-P-S Virtual Kiosks | Activate S-P-S Virtual Kiosks

Standard Demonstration Mode

Common Operations of Service-Provider Specific Virtual Kiosk

Client Account: DISNEY | Client Account No: 7145001 | User Name: John Smith

Congratulations, you have created the following Service-Provider-Specific Virtual Kiosks, you can now Modify or Deploy these Service-Provider-Specific Virtual Kiosks.

Service-Provider-Specific Virtual Kiosk Name	Service-Provider-Specific Virtual Kiosk Serial Number
Here will go the description of the product.	0900938-78383
Here will go the description of the product.	0900938-78383
Here will go the description of the product.	0900938-78383
Here will go the description of the product.	0900938-78383
Here will go the description of the product.	0900938-78383

◀ | ◀ Back | 1 2 3 4 5 Next ▶ | ▶▶

548/1046

FIG. 48R8



Control Panel for Generating Service-Provider Specific (S-P-S) Virtual Kiosks

Configure S-P-S Virtual Kiosks | Create S-P-S Virtual Kiosks | Modify S-P-S Virtual Kiosks | Deploy S-P-S Virtual Kiosks | Activate S-P-S Virtual Kiosks

Standard Demonstration Mode

Select the Service-Provider Specific Virtual Kiosk

Client Account: DISNEY | Client Account No: 7145001 | User Name: John Smith

Select the Service-Provider-Specific Virtual Kiosks you wish to modify by clicking on the Virtual Kiosk ID Number.

Virtual Kiosks ID Number	Store Location	Virtual Kiosk Name	Deployed	Active
<u>9909930-00939</u>	Here will go the store location	Virtual Kiosk name	✓	✓
<u>9909930-00939</u>	Here will go the store location	Virtual Kiosk name	✓	✓
<u>9909930-00939</u>	Here will go the store location	Virtual Kiosk name	✓	X
<u>9909930-00939</u>	Here will go the store location	Virtual Kiosk name	✓	✓
<u>9909930-00939</u>	Here will go the store location	Virtual Kiosk name	✓	X

44 | Back 1 2 3 4 5 | Next >>

549/1046

FIG 4851



Control Panel for Generating Service Provider Specific (S.P.S) Virtual Kiosks

Configure S.P.S Virtual Kiosks | Create S.P.S Virtual Kiosks | Modify S.P.S Virtual Kiosks | Deploy S.P.S Virtual Kiosks | Activate S.P.S Virtual Kiosks

Standard Demonstration Mode

Client Account: DISNEY | Client Account No: 7145001 | User Name: John Smith

Update the information for the selected Virtual Kiosk. Click Update to save your changes. Click Update Brands to update the list of Brand Entities associated with the selected Virtual Kiosk.

Virtual Kiosk Serial Number: 09009876-09

Virtual Kiosk Name:

Display Mode:
 Tri-Mode Display comprising: Advertising Spot Display Mode, Promotional Spot Display Mode, and Brand Information Network Display Mode

Dual-Mode Display comprising: Advertising Spot Display Mode, and Brand Information Network Display Mode

Uni-Mode Display comprising: Brand Information Network Display Mode

Allow Consumer Installation:
 Yes No

Virtual Kiosk Status: Deployed-Activated

FIG. 4852

550/1046



Control Panel for Generating Service-Provider Specific (S-P-S) Virtual Kiosks

Configure S-P-S Virtual Kiosks | Create S-P-S Virtual Kiosks | Modify S-P-S Virtual Kiosks | Deploy S-P-S Virtual Kiosks | Activate S-P-S Virtual Kiosks

Standard Demonstration Mode

Client Account: DISNEY | Client Account No: 7145001 | User Name: John Smith

The Service-Provider-Specific Virtual Kiosk (Name) has been modified. Please review and confirm your modifications. If any information is not correct then click Edit to correct and update. Click Update Brands to update the list of Brand Entities associated with the selected Virtual Kiosk.

Virtual Kiosk Serial Number: 09009876-09

Virtual Kiosk Name: Virtual Kiosk Name

Virtual Kiosk Mode: Promo-Spot Display Mode

Allow Retailer Installation: Yes

Allow Industrialist Installation: No

Allow Consumer Installation: Yes

Virtual Kiosk Status: Deployed-Activated

Exit | Update Brands | Confirm

FIG. 4853

550/1046



Control Panel for Generating Service-Provider Specific (S-P-S) Virtual Kiosks

Configure S-P-S Virtual Kiosks | Create S-P-S Virtual Kiosks | Modify S-P-S Virtual Kiosks | Dep. by S-P-S Virtual Kiosks | Activate S-P-S Virtual Kiosks

Standard Demonstration Mode

Client Account: DISNEY | Client Account No: 7145001 | User Name: John Smith

Please review the list of Brand Entities assigned to the Service-Provider-Specific Virtual Kiosks. To remove an associated Brand Entity from the Virtual Kiosk, simply uncheck the Active checkbox. To add new Brand Entities to the Virtual Kiosk list, click the Add Brands button. If you do not wish to add any more, click Finish to confirm the Virtual Kiosk Brand Entity list.

Brand Entity Name	Brand Entity Owner	Service Mark (SM)	Service Descriptor (SD)	Selected
Here will go the Brand Entity	Here will go the Brand Entity Owner	Here will go the service mark	Here will go the description of the service. Here will go the description of the service.	<input checked="" type="checkbox"/>
Here will go the Brand Entity	Here will go the Brand Entity Owner	Here will go the service mark	Here will go the description of the service. Here will go the description of the service.	<input checked="" type="checkbox"/>
Here will go the Brand Entity	Here will go the Brand Entity Owner	Here will go the service mark	Here will go the description of the service. Here will go the description of the service.	<input checked="" type="checkbox"/>
Here will go the Brand Entity	Here will go the Brand Entity Owner	Here will go the service mark	Here will go the description of the service. Here will go the description of the service.	<input checked="" type="checkbox"/>
Here will go the Brand Entity	Here will go the Brand Entity Owner	Here will go the service mark	Here will go the description of the service. Here will go the description of the service.	<input checked="" type="checkbox"/>

Back 1 2 3 4 5 Next



FIG. 4854

552/1046



Control Panel for Generating Service-Provider Specific (S-P-S) Virtual Kiosks

Configure S-P-S Virtual Kiosks | Create S-P-S Virtual Kiosks | Modify S-P-S Virtual Kiosks | Deploy S-P-S Virtual Kiosks | Activate S-P-S Virtual Kiosks

Standard Demonstration Mode

Search for Brand Entities

Client Account: DISNEY | Client Account No: 7145001 | User Name: John Smith

Search for the Brand Entities to add to the Service-Specific Virtual Kiosks. You may search by the Service Mark, Service Descriptor or Brand Entity Name. Enter the search criteria in the textbox, select the parameters from the dropdown list and click the Search button to initiate the Brand Entity search.

Search for:

By: Service Mark



FIG. 4855

553/1046



Control Panel for Generating Service Provider Specific (S-P-S) Virtual Kiosks

Configure S-P-S Virtual Kiosks | Create S-P-S Virtual Kiosks | Modify S-P-S Virtual Kiosks | Activate S-P-S Virtual Kiosks

Standard Demonstration Mode

Client Account: DISNEY | Client Account No: 7145001 | User Name: John Smith

Select the Brand Entities to add to the Vendor-Specific Virtual Kiosks.

Brand Entity Name	Brand Entity Owner	Service Mark (SM)	Service Descriptor (SD)	Add to Kiosk
Here will go the Brand Entity	Here will go the Brand Entity Owner	Here will go the service mark	Here will go the description of the service. Here will go the description of the service.	<input type="checkbox"/>
Here will go the Brand Entity	Here will go the Brand Entity Owner	Here will go the service mark	Here will go the description of the service. Here will go the description of the service.	<input type="checkbox"/>
Here will go the Brand Entity	Here will go the Brand Entity Owner	Here will go the service mark	Here will go the description of the service. Here will go the description of the service.	<input type="checkbox"/>
Here will go the Brand Entity	Here will go the Brand Entity Owner	Here will go the service mark	Here will go the description of the service. Here will go the description of the service.	<input type="checkbox"/>
Here will go the Brand Entity	Here will go the Brand Entity Owner	Here will go the service mark	Here will go the description of the service. Here will go the description of the service.	<input type="checkbox"/>

◀◀ | ◀ Back 1 2 3 4 5 Next ▶▶



FIG. 4856

554/1046



Control Panel for Generating Service Provider Specific (S.P.S) Virtual Kiosks

Configure S.P.S Virtual Kiosks | Create S.P.S Virtual Kiosks | Modify S.P.S Virtual Kiosks | Deploy S.P.S Virtual Kiosks | Activate S.P.S Virtual Kiosks

Standard Demonstration Mode

Client Account: DISNEY | Client Account No: 7145001 | User Name: John Smith

The Service-Provider-Specific Virtual Kiosk has been modified. Please review and confirm the information below. If any information is not correct then click Edit to correct and update.

Name: Name goes here
ID: 0944930-9386399
Mode: Ad-Spot Display Mode

List of Brand Entities	Brand Entity Name	Brand Entity Owner	Service Mark (SM)	Service Descriptor (SD)
Here will go the Brand Entity	Here will go the Brand Entity Owner	Here will go the service mark	Here will go the description of the service. Here will go the description of the service.	
Here will go the Brand Entity	Here will go the Brand Entity Owner	Here will go the service mark	Here will go the description of the service. Here will go the description of the service.	
Here will go the Brand Entity	Here will go the Brand Entity Owner	Here will go the service mark	Here will go the description of the service. Here will go the description of the service.	
Here will go the Brand Entity	Here will go the Brand Entity Owner	Here will go the service mark	Here will go the description of the service. Here will go the description of the service.	
Here will go the Brand Entity	Here will go the Brand Entity Owner	Here will go the service mark	Here will go the description of the service. Here will go the description of the service.	

Back 1 2 3 4 5 Next



FIG. 4857

555/1046



Control Panel for Generating Service-Provider-Specific (S-P-S) Virtual Kiosks

Configure S-P-S Virtual Kiosks
 Create S-P-S Virtual Kiosks
 Modify S-P-S Virtual Kiosks
 Deploy S-P-S Virtual Kiosks
 Activate S-P-S Virtual Kiosks

Standard Demonstration Mode

Client Account: DISNEY
 Client Account No: 7145001
 User Name: John Smith

Service-Provider-Specific Virtual Kiosk can be Deployed to Launch from one of four different Environments:

- An HTML-Encoded Brandkey(TM) Button for launching the Service-Provider-Specific Virtual Kiosk from any web page once the Brandkey(TM) Button and its accompanying Virtual Kiosk Tag have been installed in the page.
- An HTML-Encoded Document for launching the Service-Provider-Specific Virtual Kiosk from a Word or PDF Document once the Document containing its Virtual Kiosk Tag have been downloaded.
- An HTML-Encoded Image for launching the Service-Provider-Specific Virtual Kiosk from any web page once the Image and its accompanying Virtual Kiosk Tag have been installed in the page.
- An HTML-Encoded Desktop Icon for launching the Service-Provider-Specific Virtual Kiosk from any Computer Desktop once the Desktop Icon containing its Virtual Kiosk Tag has been installed on the Computer Desktop.

Select the Environment from which the selected Service-Provider-Specific Virtual Kiosks will be launched:

- HTML-Encoded Brandkey (TM) Button
- HTML-Encoded Document
- HTML-Encoded Image
- HTML-Encoded Desktop Icon

Next

FIG 48T1

556/1046



Configure S-P-S Virtual Kiosks

Create S-P-S Virtual Kiosks

Modify S-P-S Virtual Kiosks

Deploy S-P-S Virtual Kiosks

Activate S-P-S Virtual Kiosks

Control Panel for Generating Service Provider Specific S-P-S Virtual Kiosks

Standard Demonstration Mode

Select Service-Provider-Specific Virtual Kiosk(s)

Client Account: DISNEY

Client Account No: 7145001

User Name: John Smith

Select the Service-Provider-Specific Virtual Kiosk(s) you wish to deploy.

Virtual Kiosk ID	Service-Provider-Specific Virtual Kiosk Name	Deploy
9909930-00939	Here will go the description of the retailer.	<input type="radio"/>
9909930-00939	Here will go the description of the retailer.	<input type="radio"/>
9909930-00939	Here will go the description of the retailer.	<input type="radio"/>
9909930-00939	Here will go the description of the retailer.	<input type="radio"/>
9909930-00939	Here will go the description of the retailer.	<input type="radio"/>

44 | < Back 1 2 3 4 5 Next > | >>



FIG. 4872

557/1046



Control Panel for Generating Service Provider Specific (S.P.S.) Virtual Kiosks

Configure S.P.S. Virtual Kiosks | Create S.P.S. Virtual Kiosks | Modify S.P.S. Virtual Kiosks | Deploy S.P.S. Virtual Kiosks | Activate S.P.S. Virtual Kiosks

Standard Demonstration Mode

Client Account: DISNEY | Client Account No: 7145001 | User Name: John Smith

Select the languages in which you wish to deploy the configured Service-Provider-Specific Virtual Kiosks.

Language	Selected	Language	Selected
English	<input type="checkbox"/>	Austrian	<input checked="" type="checkbox"/>
Spanish	<input checked="" type="checkbox"/>	Brazilian	<input checked="" type="checkbox"/>
French	<input checked="" type="checkbox"/>	Canadian French	<input checked="" type="checkbox"/>
German	<input checked="" type="checkbox"/>	Catalan	<input checked="" type="checkbox"/>
Japanese	<input checked="" type="checkbox"/>	Finnish	<input checked="" type="checkbox"/>
Dutch	<input checked="" type="checkbox"/>	Norwegian	<input checked="" type="checkbox"/>
Italian	<input checked="" type="checkbox"/>	Portuguese	<input checked="" type="checkbox"/>
Chinese	<input checked="" type="checkbox"/>	Swedish	<input checked="" type="checkbox"/>
Danish	<input checked="" type="checkbox"/>		



FIG. 4873A

5501046



Control Panel for Generating Service Provider Specific (S.P.S) Virtual Kiosks

Configure S-P-S Virtual Kiosks | Create S-P-S Virtual Kiosks | Modify S-P-S Virtual Kiosks | Deploy S-P-S Virtual Kiosks | Activate S-P-S Virtual Kiosks

Standard Demonstration Mode

CREATE NEW ENCODED DOCUMENT

Client Account: DISNEY | Client Account No: 7145001 | User Name: John Smith

Create or import the document into which you wish to embed the Service-Provider-Specific Virtual Kiosk tag. Click the Import button to load an existing document. The document must be in World format to load correctly.

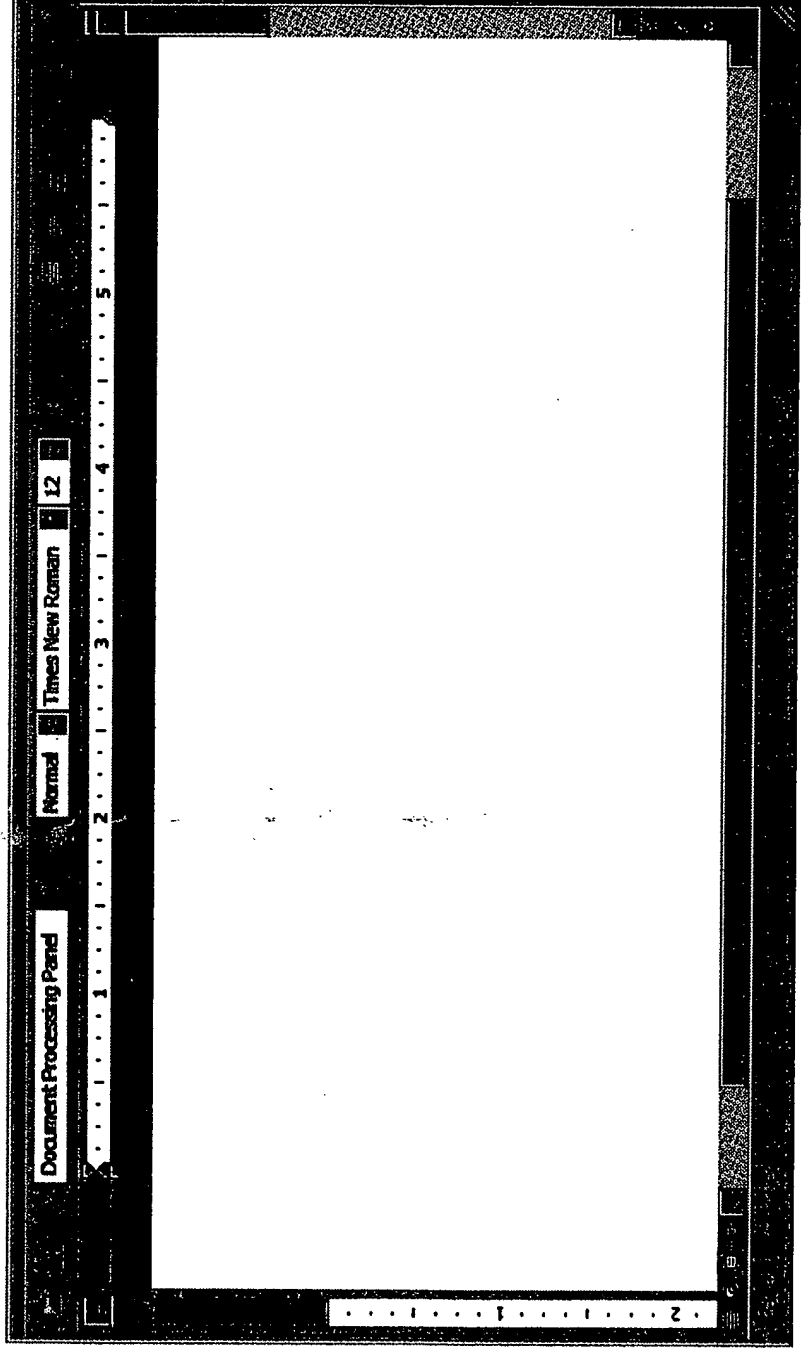

FIG. 48T3B

559/1046

565/1046



FIG. 4873C



Control Panel for Managing Service Provider Specific (S.P.S) Virtual Kiosks

Configure S-P-S Virtual Kiosks | Create S-P-S Virtual Kiosks | Modify S-P-S Virtual Kiosks | Deploy S-P-S Virtual Kiosks | Activate S-P-S Virtual Kiosks

Standard Demonstration Mode

SELECT THE DOCUMENT FORMAT

Client Account: DISNEY | Client Account No: 7145001 | User Name: John Smith

The HTML-Embedded document has been saved. Please select the format of the HTML-Embedded document you wish to deploy to the Brandkey Systems Web Server.

- Microsoft Word Document format
- Adobe PDF Document format



FIG. 4873D

560/1046



Control Panel for Generating Service-Provider-Specific (S.P.S) Virtual Kiosks

Configure S.P.S Virtual Kiosks | Create S.P.S Virtual Kiosks | Modify S.P.S Virtual Kiosks | Deploy S.P.S Virtual Kiosks | Activate S.P.S Virtual Kiosks

Standard Demonstration Mode

Client Account: DISNEY | Client Account No: 7145001 | User Name: John Smith

Select the Service-Provider-Specific Virtual Kiosk(s) you wish to deploy.

Virtual Kiosk ID	Service-Provider-Specific Virtual Kiosk Name	Deploy
9909930-00939	Here will go the description of the retailer.	<input type="radio"/>
9909930-00939	Here will go the description of the retailer.	<input type="radio"/>
9909930-00939	Here will go the description of the retailer.	<input type="radio"/>
9909930-00939	Here will go the description of the retailer.	<input type="radio"/>
9909930-00939	Here will go the description of the retailer.	<input type="radio"/>

4 | < Back 1 2 3 4 5 Next > | >>



FIG. 4873E

562/1046

Control Panel for Generating Service Provider Specific (S.P.S) Virtual Kiosks



Configure S.P.S Virtual Kiosks | Create S.P.S Virtual Kiosks | Modify S.P.S Virtual Kiosks | Deploy S.P.S Virtual Kiosks | Activate S.P.S Virtual Kiosks

Standard Demonstration Mode

Select Service Provider Specific Virtual Kiosks

Client Account: DISNEY | Client Account No: 7145001 | User Name: John Smith

Select the languages in which you wish to deploy the configured Virtual Kiosks.

Language	Selected	Language	Selected
English	<input type="checkbox"/>	Austrian	<input checked="" type="checkbox"/>
Spanish	<input checked="" type="checkbox"/>	Brazilian	<input checked="" type="checkbox"/>
French	<input checked="" type="checkbox"/>	Canadian French	<input checked="" type="checkbox"/>
German	<input checked="" type="checkbox"/>	Catalan	<input checked="" type="checkbox"/>
Japanese	<input checked="" type="checkbox"/>	Finnish	<input checked="" type="checkbox"/>
Dutch	<input checked="" type="checkbox"/>	Norwegian	<input checked="" type="checkbox"/>
Italian	<input checked="" type="checkbox"/>	Portuguese	<input checked="" type="checkbox"/>
Chinese	<input checked="" type="checkbox"/>	Swedish	<input checked="" type="checkbox"/>
Danish	<input checked="" type="checkbox"/>		

Back Next

FIG. 4873F

563/1046



Configure S-P-S Virtual Kiosks | Create S-P-S Virtual Kiosks | Modify S-P-S Virtual Kiosks | Deploy S-P-S Virtual Kiosks | Activate S-P-S Virtual Kiosks

Control Panel for Generating Service-Provider Specific (S-P-S) Virtual Kiosks

Standard Demonstration Mode

Client Account: DISNEY

Client Account No: 7145001

User Name: John Smith

Select the image to upload that you wish to use as the base image for the HTML-Encoded Image you wish to create.

Base Image:

Select the image to upload that you wish to use as the secondary image to place on top of the base image for the HTML-Encoded image you wish to create.

Secondary Image:

Base Next

FIG. 48739

504/1046



Control Panel for Generating Service-Provider Specific (S-P-S) Virtual Kiosks

Configure S-P-S Virtual Kiosks | Create S-P-S Virtual Kiosks | Modify S-P-S Virtual Kiosks | Deploy S-P-S Virtual Kiosks | Activate S-P-S Virtual Kiosks

Standard Demonstration Mode

HTML ENCODED IMAGE

Client Account: DISNEY | Client Account No: 7145001 | User Name: John Smith

Use the window below to format your new image which shall be used in the HTML-Encoded Image you wish to create. You may resize both the images if you wish. The Secondary Image shall always appear on top of the Base Image.

STEP 2: CUSTOMIZE Beely-T Shirt

FIG. 4873 H

505/1046



566/1046

FIG. 4873I



Control Panel for Generating Service-Provider Specific (S.P.S) Virtual Kiosks

Configure S.P.S Virtual Kiosks | Create S.P.S Virtual Kiosks | Modify S.P.S Virtual Kiosks | Deploy S.P.S Virtual Kiosks | Activate S.P.S Virtual Kiosks

Standard Demonstration Mode

STEP 2: CUSTOMIZE BEEFY T SHIRT

Client Account: DISNEY | Client Account No: 7145001 | User Name: John Smith

The image you created is shown below. Please specify the area over which the consumer will click to launch the Service-Provider-Specific Virtual Kiosk.

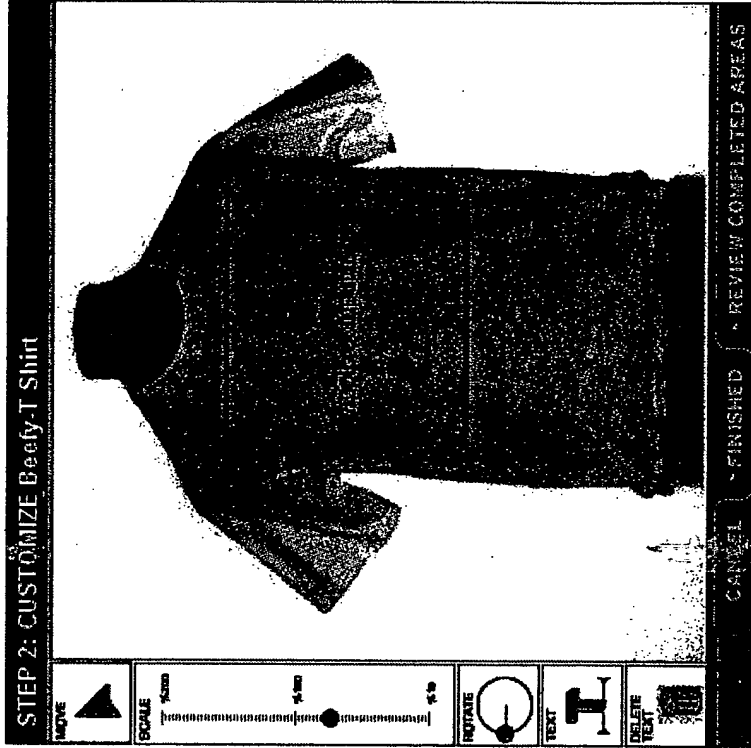

FIG. 48T 3J

567/10410

Back

Next

508/1046

FIG. 4873K



Control Panel for Generating Service-Provider-Specific (S-P-S) Virtual Kiosks

Configure S-P-S Virtual Kiosks | Create S-P-S Virtual Kiosks | Modify S-P-S Virtual Kiosks | Deploy S-P-S Virtual Kiosks | Activate S-P-S Virtual Kiosks

Standard Demonstration Mode

Client Account: DISNEY | Client Account No: 7145001 | User Name: John Smith

Select the Service-Provider-Specific Virtual Kiosk(s) you wish to deploy.

Virtual Kiosk ID	Service-Provider-Specific Virtual Kiosk Name	Deploy
9909930-00939	Here will go the description of the retailer.	<input type="radio"/>
9909930-00939	Here will go the description of the retailer.	<input type="radio"/>
9909930-00939	Here will go the description of the retailer.	<input type="radio"/>
9909930-00939	Here will go the description of the retailer.	<input type="radio"/>
9909930-00939	Here will go the description of the retailer.	<input type="radio"/>

Back 1 2 3 4 5 Next >>>

FIG. 4873L

509/1046



Control Panel for Generating Service Provider Specific (S-P-S) Virtual Kiosks

Configure S-P-S Virtual Kiosks | Create S-P-S Virtual Kiosks | Modify S-P-S Virtual Kiosks | Deo by S-P-S Virtual Kiosks | Activate S-P-S Virtual Kiosks

Standard Demonstration Mode

Select ~~Service Provider Specific~~ Virtual Kiosk Language

Client Account: DISNEY | Client Account No: 7145001 | User Name: John Smith

Select the languages in which you wish to deploy the configured Virtual Kiosks.

Language	Selected	Language	Selected
English	<input type="checkbox"/>	Austrian	<input checked="" type="checkbox"/>
Spanish	<input checked="" type="checkbox"/>	Brazilian	<input checked="" type="checkbox"/>
French	<input checked="" type="checkbox"/>	Canadian French	<input checked="" type="checkbox"/>
German	<input checked="" type="checkbox"/>	Catalan	<input checked="" type="checkbox"/>
Japanese	<input checked="" type="checkbox"/>	Finnish	<input checked="" type="checkbox"/>
Dutch	<input checked="" type="checkbox"/>	Norwegian	<input checked="" type="checkbox"/>
Italian	<input checked="" type="checkbox"/>	Portuguese	<input checked="" type="checkbox"/>
Chinese	<input checked="" type="checkbox"/>	Swedish	<input checked="" type="checkbox"/>
Danish	<input checked="" type="checkbox"/>		



FIG. 4873M

570/1046



Control Panel for Generating Service Provider Specific (S.P.S) Virtual Kiosks

Configure S-P-S Virtual Kiosks | Create S-P-S Virtual Kiosks | Modify S-P-S Virtual Kiosks | Deploy S-P-S Virtual Kiosks | Activate S-P-S Virtual Kiosks

Standard Demonstration Mode

Upload Image for HTML-Encoded Icon

Client Account: DISNEY | Client Account No: 7145001 | User Name: John Smith

Please Upload the image you wish to use as the icon for the HTML-Encoded icon you wish to deploy.

Icon Image:

Back Next

FIG. 4873N

570/1046



Control Panel for Generating Service-Provider Specific (S-P-S) Virtual Kiosks

Configure S-P-S Virtual Kiosks | Create S-P-S Virtual Kiosks | Modify S-P-S Virtual Kiosks | Deploy S-P-S Virtual Kiosks | Activate S-P-S Virtual Kiosks

Standard Demonstration Mode

Common Deployment of Service-Provider Specific Virtual Kiosks

Client Account: DISNEY | Client Account No: 7145001 | User Name: John Smith

The selected Service-Provider-Specific Virtual Kiosks have now been Deployed in the selected Launch Environment. To prepare the Deployed Service-Provider-Specific Virtual Kiosks for Installation, you must first Activate them.

5731 1046

FIG. 4875



Central Panel for Generating Service-Provider Specific (S-P-S) Virtual Kiosks

Configure S-P-S Virtual Kiosks | Create S-P-S Virtual Kiosks | Modify S-P-S Virtual Kiosks | Deactivate S-P-S Virtual Kiosks

Standard Demonstration Mode

Central Panel for Generating Service-Provider Specific Virtual Kiosks

Client Account: DISNEY | Client Account No: 7145001 | User Name: John Smith

The Virtual Kiosks below have been deployed. You can activate any of the Virtual Kiosk by checking the Active field for that Virtual Kiosk. To deactivate any Virtual Kiosk simply uncheck the Active field for the Virtual Kiosk. Click Update to save the changes.

Virtual Kiosk ID	Virtual Kiosk Name	Active
Here will go the min	Here will go the product name	<input checked="" type="checkbox"/>
Here will go the min	Here will go the product name	<input type="checkbox"/>
Here will go the min	Here will go the product name	<input type="checkbox"/>
Here will go the min	Here will go the product name	<input type="checkbox"/>
Here will go the min	Here will go the product name	<input type="checkbox"/>

44 | Back 1 2 3 4 5 Next >



FIG. 48 u1

579:10416



Control Panel for Generating Retailer Specific (R-S) Virtual Kiosks

Configure R-S Virtual Kiosks | Create R-S Virtual Kiosks | Modify R-S Virtual Kiosks | Activate R-S Virtual Kiosks

Standard Demonstration Mode

Control Panel for Generating Retailer Specific (R-S) Virtual Kiosks

Client Account: DISNEY | Client Account No: 7145001 | User Name: John Smith

Text: R:144

575/1046

FIG. 49A



Control Panel for Generating Retailer-Specific (R-S) Virtual Kiosks

Configure R-S Virtual Kiosks | Create R-S Virtual Kiosks | Modify R-S Virtual Kiosks | Deploy R-S Virtual Kiosks | Activate R-S Virtual Kiosks

Standard Demonstration Mode

Set Standard Configuration

Client Account: DISNEY | Client Account No: 7145001 | User Name: John Smith

Do you wish to create a Retailer-Specific Virtual Kiosk for all registered products?

- Yes No

Do you wish to allow for creation of custom Retailer-Specific Virtual Kiosks?

- Yes No

By default do you wish to allow installation of Retailer-Specific Virtual Kiosks by Consumers?

- Yes No

576/1046



FIG. 49 B1



Control Panel for Generating Retailer Specific (R-S) Virtual Kiosks

Configure R-S Virtual Kiosks | Create R-S Virtual Kiosks | Modify R-S Virtual Kiosks | Deploy R-S Virtual Kiosks | Activate R-S Virtual Kiosks

Standard Demonstration Mode

Allowed Industrialists

Client Account: DISNEY | Client Account No: 7145001 | User Name: John Smith

You have selected to allow the following Industrialists to install Retailer-Specific Virtual Kiosks you create. If you wish to remove an Industrialist from this list, then uncheck the Active checkbox next to their name. Click Next to save your changes. Click Add Industrialists to add additional Industrialists to this list.

Industrialist Name	City	State	Zip/Postal Code	Country	Active
Industrialist Name 1	City 1	State 1	Zip/Postal Code 1	Country 1	<input type="checkbox"/>
Industrialist Name 2	City 2	State 2	Zip/Postal Code 2	Country 2	<input type="checkbox"/>
Industrialist Name 3	City 3	State 3	Zip/Postal Code 3	Country 3	<input type="checkbox"/>
Industrialist Name 4	City 4	State 4	Zip/Postal Code 4	Country 4	<input type="checkbox"/>
Industrialist Name 5	City 5	State 5	Zip/Postal Code 5	Country 5	<input type="checkbox"/>

Back | 1 2 3 4 5 | Next

Back | Add Industrialist | Next

FIG. 49BZ

577/1046



Control Panel for Generating Retailer-Specific (R-S) Virtual Kiosks

Configure R-S Virtual Kiosks | Create R-S Virtual Kiosks | Modify R-S Virtual Kiosks | Deactivate R-S Virtual Kiosks | Activate R-S Virtual Kiosks

Standard Demonstration Mode

Search for Industrialists

Client Account: DISNEY | Client Account No: 7145001 | User Name: John Smith

Search for the Industrialists you wish to add to the list of Industrialists allowed to install Retailer-Specific Virtual Kiosks. You can search by Name, City, State, Zip/Postal Code and Country. Click Search to initiate the Industrialist search.

Industrialist Name:

City:

State:

Zip/Postal Code:

Country:



FIG. 49B3

5700/1046



Control Panel for Generating Retailer Specific (R-S) Virtual Kiosks

Configure R-S Virtual Kiosks | Create R-S Virtual Kiosks | Modify R-S Virtual Kiosks | Dep by R-S Virtual Kiosks | Activate R-S Virtual Kiosks

Standard Demonstration Mode

Select Industrialists

Client Account: DISNEY | Client Account No: 7145001 | User Name: John Smith

The following Industrialists matched your search criteria. Check the Add Industrialist to add the Industrialist to the list of Industrialists allowed to install your Retailer-Specific Virtual Kiosks. Click Next to save your changes. Click Back to redo your search.

Industrialist Name	City	State	Zip/Postal Code	Country	Add Industrialist
Industrialist Name	Norwalk	Connecticut	06903	United States	<input type="checkbox"/>
Industrialist Name	Stamford	Connecticut	06903	United States	<input type="checkbox"/>
Industrialist Name	New York	New York	06903	United States	<input type="checkbox"/>
Industrialist Name	Norwalk	Connecticut	06903	United States	<input type="checkbox"/>
Industrialist Name	Stamford	Connecticut	06903	United States	<input type="checkbox"/>

4 | 4 Back 1 2 3 4 5 Next |>>



FIG. 49B4

5/19/2003



Control Panel for Generating Retailer Specific (R-S) Virtual Kiosks

Configure R-S Virtual Kiosks | Create R-S Virtual Kiosks | Modify R-S Virtual Kiosks | Activate R-S Virtual Kiosks

Standard Demonstration Mode

Client Account: DISNEY | Client Account No: 7145001 | User Name: John Smith

You have chosen to Forbid the following Domains from launching your Retailer-Specific Virtual Kiosks. If you wish to remove a Domain from the list, uncheck the Forbidden checkbox. Click Next to save your changes. Click Add Domain to add another Domain to the Forbidden Domains List.

Domain Name	Forbidden
Domain Name 1	<input checked="" type="checkbox"/>
Domain Name 2	<input checked="" type="checkbox"/>
Domain Name 3	<input checked="" type="checkbox"/>
Domain Name 4	<input checked="" type="checkbox"/>
Domain Name 5	<input checked="" type="checkbox"/>

14 | < Back 12345 Next > | >>

Back Add Domain Finish

FIG. 49B5

505/1046



Control Panel for Generating Retailer Specific (R-S) Virtual Kiosks

Configure R-S Virtual Kiosks | Create R-S Virtual Kiosks | Modify R-S Virtual Kiosks | Activate R-S Virtual Kiosks

Standard Demonstration Mode

Account Information

Client Account: DISNEY | Client Account No: 7145001 | User Name: John Smith

Enter the Root Domain Name you wish to add to the Forbidden Domain List and click Next to save it to the list. The Root Domain name is the basic Domain Name of the site you wish to block, e.g.: www.mystore.com.

Root Domain Name:

Back Next

FIG. 49B6

501/1046



Control Panel for Generating Retailer Specific (R-S) Virtual Kiosks

Configure R-S Virtual Kiosks | Create R-S Virtual Kiosks | Modify R-S Virtual Kiosks | Deploy R-S Virtual Kiosks | Activate R-S Virtual Kiosks

Standard Demonstration Mode

Client Account: DISNEY | Client Account No: 7145001 | User Name: John Smith

Please select the display mode that will be assigned to the Retailer-Specific Virtual Kiosks you will be creating in this section:

- Tri-Mode Display featuring Promotional Spots + Advertising Spots + the Brand Information Network
- Dual-Mode Display featuring Advertising Spots + the Brand Information Network
- Single-Mode Display featuring the Brand Information Network

Next

FIG. 47C1

502/1046



Control Panel for Generating Retailer Specific (R-S) Virtual Kiosks

Configure R-S Virtual Kiosks | Create R-S Virtual Kiosks | Modify R-S Virtual Kiosks | Deploy R-S Virtual Kiosks | Activate R-S Virtual Kiosks

Standard Demonstration Mode

Search for Brand Number

Client Account: DISNEY | Client Account No: 7145001 | User Name: John Smith

Identify the products for which a Retailer-Specific Virtual Kiosk will be created. You may search by Universal Product Number, Trade Mark, Product Descriptor, Brand Entity Name or Product Name. Enter your search criteria in the textbox, select the parameters from the dropdown list and click search to initiate the product search.

Search Criteria:

By: Universal Product Number

583/1040

Back Search

FIG. 49C2



Control Panel for Generating Retailer-Specific (R-S) Virtual Kiosks

[Configure R-S Virtual Kiosks](#) |
 [Create R-S Virtual Kiosks](#) |
 [Modify R-S Virtual Kiosks](#) |
 [Deactivate R-S Virtual Kiosks](#) |
 [Activate R-S Virtual Kiosks](#)

Standard Demonstration Mode

Client Account: DISNEY |
 Client Account No: 7145001 |
 User Name: John Smith

Select the products to add to the Retailer-Specific Virtual Kiosks.

UPN	TM	PD	Product Name	Vendor	Add to Kiosk
Here will go the min	Here will go the vendor	Here will go the status	Here will go the product name	Here will go the name of the vendor	<input checked="" type="checkbox"/>
Here will go the min	Here will go the vendor	Here will go the status	Here will go the product name	Here will go the name of the vendor	<input checked="" type="checkbox"/>
Here will go the min	Here will go the vendor	Here will go the status	Here will go the product name	Here will go the name of the vendor	<input checked="" type="checkbox"/>
Here will go the min	Here will go the vendor	Here will go the status	Here will go the product name	Here will go the name of the vendor	<input checked="" type="checkbox"/>
Here will go the min	Here will go the vendor	Here will go the status	Here will go the product name	Here will go the name of the vendor	<input checked="" type="checkbox"/>

[Back](#) |
 [1](#) |
 [2](#) |
 [3](#) |
 [4](#) |
 [5](#) |
 [Next](#)

504/1046

FIG. 49C3





Control Panel for Generating Retailer Specific (R-S) Virtual Kiosks

Configure R-S Virtual Kiosks | Create R-S Virtual Kiosks | Modify R-S Virtual Kiosks | Activate R-S Virtual Kiosks |

Standard Demonstration Mode

Name: Retailer-Specific Virtual Kiosk

Client Account: DISNEY | Client Account No: 7145001 | User Name: John Smith

Name the Retailer-Specific Virtual Kiosk you have just created.

Virtual Kiosk ID

Here will go the virtual kiosk ID

Vendor

Here will go the vendor

Virtual Kiosk Name

<< | < Back 1 2 3 4 5 Next > | >>

505/1046



FIG. 49C4



Control Panel for Generating Retailer Specific (R-S) Virtual Kiosks

Configure R-S Virtual Kiosks | Create R-S Virtual Kiosks | Modify R-S Virtual Kiosks | Deploy R-S Virtual Kiosks | Activate R-S Virtual Kiosks
Standard Demonstration Mode

Customize Retailer-Specific Virtual Kiosk

Client Account: DISNEY | Client Account No: 7145001 | User Name: John Smith

Select the Virtual Kiosk you wish to customize by clicking on the Virtual Kiosk Name. When you have finished Customizing the Retailer-Specific Virtual Kiosk click the Next button.

Retailer-Specific Virtual Kiosk Name
Irek@Cycles 2002

Retailer-Specific Serial Number
09890-0989

586/1046

FIG. 49C5



<http://www.brandkeysystems.com/bk-deliver/m-launch-retailer-create-s.html>
<file:///E:/www/brandkey/bk-deliver/TAMP50m0hej6yt.htm>



Control Panel for Generating Retailer Specific (R-S) Virtual Kiosks

Configure R-S Virtual Kiosks | Create R-S Virtual Kiosks | Modify R-S Virtual Kiosks | Activate R-S Virtual Kiosks
Set Virtual Kiosk Display Area | Edit Virtual Kiosk | Assign Virtual Kiosk | Supermarket Virtual Kiosk | Casino Virtual Kiosk |

Standard Demonstration Mode

Client Account: DISNEY | Client Account No: 7145001 | User Name: John Smith

Customize your Retailer-Specific Virtual Kiosk by selecting the desired Customization Options. Click Preview to preview the appearance of the customized Retailer-Specific Virtual Kiosk. Click Confirm to confirm the changes. Click Cancel to cancel your changes.

Customization Options

Retailer Logo:

Geometric Layout: square

Surface Texture: Black

Surface Color: Black

Button Style Set: square

Button Color Set: Black

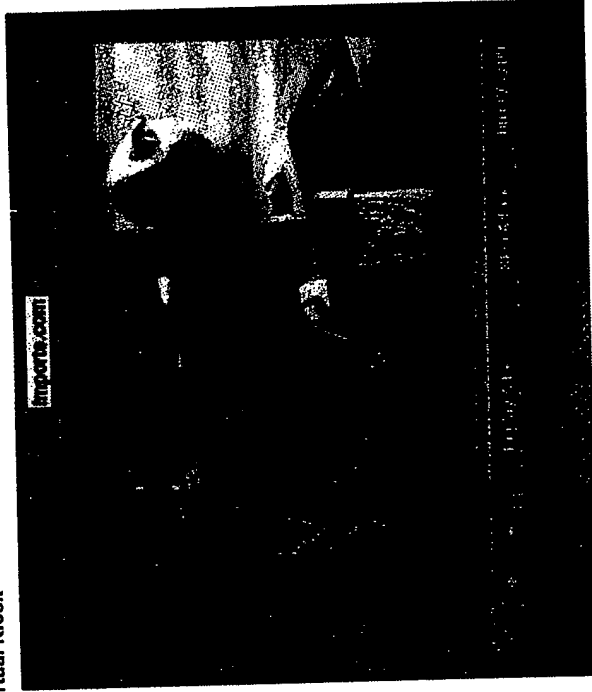

Virtual Kiosk

Confirm

FIG. 49c6

507/1046



588/1046

FIG. 49C7

6/18/2003



Control Panel for Generating Retailer-Specific (R-S) Virtual Kiosks

[Configure R-S Virtual Kiosks](#) |
 [Create R-S Virtual Kiosks](#) |
 [Modify R-S Virtual Kiosks](#) |
 [Deploy R-S Virtual Kiosks](#) |
 [Activate R-S Virtual Kiosks](#)

Standard Demonstration Mode

System Parameters for Retailer-Specific Virtual Kiosks

Client Account: DISNEY |
 Client Account No: 7145001 |
 User Name: John Smith

Congratulations, you have created the following Retailer-Specific Virtual Kiosks, you can now Modify or Deploy these Retailer-Specific Virtual Kiosks.

Retailer-Specific Virtual Kiosk Name	Retailer-Specific Virtual Kiosk Serial Number
Here will go the description of the product.	0900938-78383
Here will go the description of the product.	0900938-78383
Here will go the description of the product.	0900938-78383
Here will go the description of the product.	0900938-78383
Here will go the description of the product.	0900938-78383

<< | < Back | 1 2 3 4 5 | Next > | >>

589/1046

FIG. 49C8



Control Panel for Generating Retailer-Specific (R-S) Virtual Kiosks

Configure R-S Virtual Kiosks | Create R-S Virtual Kiosks | Modify R-S Virtual Kiosks | Deploy R-S Virtual Kiosks | Activate R-S Virtual Kiosks

Standard Demonstration Mode

Client Account: DISNEY | Client Account No: 7145001 | User Name: John Smith

Select the Retailer-Specific Virtual Kiosks you wish to modify by clicking on the Virtual Kiosk ID Number.

Virtual Kiosks ID Number	Store Location	Virtual Kiosk Name	Deployed	Active
9909930-00939	Here will go the store location	Virtual Kiosk name	✓	✓
9909930-00939	Here will go the store location	Virtual Kiosk name	✓	✓
9909930-00939	Here will go the store location	Virtual Kiosk name	✓	X
9909930-00939	Here will go the store location	Virtual Kiosk name	✓	✓
9909930-00939	Here will go the store location	Virtual Kiosk name	✓	X

44 | Back 1 2 3 4 5 Next >>>

590/1046



FIG. 49 D1

Control Panel for Generating Retailer Specific (R-S) Virtual Kiosks



Configure R-S Virtual Kiosks | Create R-S Virtual Kiosks | Modify R-S Virtual Kiosks | Deploy R-S Virtual Kiosks | Activate R-S Virtual Kiosks

Standard Demonstration Mode

Client Account: DISNEY | Client Account No: 7145001 | User Name: John Smith

Update the information for the selected Virtual Kiosk. Click Update to save your changes. Click Update Brands to update the list of Brand Entities associated with the selected Virtual Kiosk.

Virtual Kiosk Serial Number: 09009876-09

Virtual Kiosk Name: [Empty text box]

Display Mode: Tri-Mode Display comprising: Advertising Spot Display Mode, Promotional Spot Display Mode, and Brand Information Network Display Mode

Dual-Mode Display comprising: Advertising Spot Display Mode, and Brand Information Network Display Mode

Uni-Mode Display comprising: Brand Information Network Display Mode

Allow Consumer Installation: Yes No

Virtual Kiosk Status: Deployed-Activated



Back | Update | Update Products

FIG. 49DZ

59/1046



Control Panel for Governing Retailer Specific (R-S) Virtual Kiosks

Configure R-S Virtual Kiosks | Create R-S Virtual Kiosks | Modify R-S Virtual Kiosks | Activate R-S Virtual Kiosks

Standard Demonstration Mode

Modify the Retailer Specific Virtual Kiosk

Client Account: DISNEY | Client Account No: 7145001 | User Name: John Smith

The Retailer-Specific Virtual Kiosk (Name) has been modified. Please review and confirm your modifications. If any information is not correct then click Edit to correct and update. Click Update Products to update the list of products associated with the selected Virtual Kiosk.

Virtual Kiosk Serial Number: 09009876-09

Virtual Kiosk Name: Virtual Kiosk Name

Virtual Kiosk Mode: Promo-Spot Display Mode

Allow Retailer Installation: Yes

Allow Industrialist Installation: No

Allow Consumer Installation: Yes

Virtual Kiosk Status: Deployed-Activated

592/1046

Edit | Update Products | Confirm

F19.49D3



Control Panel for Generating Retailer Specific (R-S) Virtual Kiosks

Configure R-S Virtual Kiosks | Create R-S Virtual Kiosks | Modify R-S Virtual Kiosks | Deactivate R-S Virtual Kiosks | Activate R-S Virtual Kiosks

Standard Demonstration Mode

Client Account: DISNEY | Client Account No: 7145001 | User Name: John Smith

Update the list of Products assigned to the Retailer-Specific Virtual Kiosks. To remove an associated product from the Virtual Kiosk simply uncheck the Active checkbox. To add new products to the Virtual Kiosk simply click the Add Products button. If you do not wish to add any more products, click Finish to confirm the Virtual Kiosk product list.

Universal Product Number (UPN)	Trade Mark (TM)	Product Descriptor (PD)	Selected
9909930-00939	Here will go the trade mark	Here will go the description of the product. Here will go the description of the product.	<input checked="" type="checkbox"/>
9909930-00939	Here will go the trade mark	Here will go the description of the product. Here will go the description of the product.	<input checked="" type="checkbox"/>
9909930-00939	Here will go the trade mark	Here will go the description of the product. Here will go the description of the product.	<input checked="" type="checkbox"/>
9909930-00939	Here will go the trade mark	Here will go the description of the product. Here will go the description of the product.	<input checked="" type="checkbox"/>
9909930-00939	Here will go the trade mark	Here will go the description of the product. Here will go the description of the product.	<input checked="" type="checkbox"/>

Back 1 2 3 4 5 Next

Finish

FIG. 49DH

593/1046



Control Panel for Generating Retailer Specific (R-S) Virtual Kiosks

Configure R-S Virtual Kiosks | Create R-S Virtual Kiosks | Modify R-S Virtual Kiosks | Activate R-S Virtual Kiosks

Standard Demonstration Mode

Search for Brand Entity

Client Account: DISNEY | Client Account No: 7145001 | User Name: John Smith

Search for the Products to add to the Retailer-Specific Virtual Kiosks. You may search by the Universal Product Number, Trade Mark, Product Descriptor, Product Name, Brand Entity Name or Brand Entity Owner. Enter the search criteria in the textbox, select the parameters from the dropdown list and click the Search button to initiate the Product search.

Search for: [text box] By: UPN [dropdown]

594/1046

Search

FIG. 49D5



Control Panel for Generating Retailer Specific (R-S) Virtual Kiosks

[Configure R-S Virtual Kiosks](#) |
 [Create R-S Virtual Kiosks](#) |
 [Modify R-S Virtual Kiosks](#) |
 [Deploy R-S Virtual Kiosks](#) |
 [Activate R-S Virtual Kiosks](#)

Standard Demonstration Mode

Select Retailer:

[Client Account: DISNEY |
 Client Account No: 7145001 |
 User Name: John Smith

Select the Products to add to the Retailer-Specific Virtual Kiosks.

UPN	TM	PD	Product Name	Vendor	Add to Kiosk	
Here will go the min	Here will go the min	Here will go the vendor	Here will go the status	Here will go the product name	Here will go the name of the vendor	<input type="checkbox"/>
Here will go the min	Here will go the min	Here will go the vendor	Here will go the status	Here will go the product name	Here will go the name of the vendor	<input type="checkbox"/>
Here will go the min	Here will go the min	Here will go the vendor	Here will go the status	Here will go the product name	Here will go the name of the vendor	<input type="checkbox"/>
Here will go the min	Here will go the min	Here will go the vendor	Here will go the status	Here will go the product name	Here will go the name of the vendor	<input type="checkbox"/>
Here will go the min	Here will go the min	Here will go the vendor	Here will go the status	Here will go the product name	Here will go the name of the vendor	<input type="checkbox"/>

595/1046

4 | < Back 1 2 3 4 5 Next > | >>

Next

FIG. 49D6



Control Panel for Generating Retailer Specific (R-S) Virtual Kiosks

Configure R-S Virtual Kiosks | Create R-S Virtual Kiosk | Modify R-S Virtual Kiosks | Deploy R-S Virtual Kiosks | Activate R-S Virtual Kiosks

Standard Demonstration Mode

Client Account: DISNEY | Client Account No: 7145001 | User Name: John Smith

Retailer-Specific Virtual Kiosk has been modified. Please review and confirm the information below. If any information is not correct then click Edit to correct and update.

Name: Name goes here

ID: 0944930-9388399

Mode: Ad-Spot Display Mode

List of Products

Universal Product Number (UPN)	Trade Mark (TM)	Product Descriptor (PD)
9909930-00939	Here will go the trade mark	Here will go the description of the product.
9909930-00939	Here will go the trade mark	Here will go the description of the product.
9909930-00939	Here will go the trade mark	Here will go the description of the product.
9909930-00939	Here will go the trade mark	Here will go the description of the product.
9909930-00939	Here will go the trade mark	Here will go the description of the product.

4 | Back 1 2 3 4 5 Next >>



FIG. 49D7

5976/1046



Control Panel for Generating Retailer Specific (R-S) Virtual Kiosks

Configure R-S Virtual Kiosks | Create R-S Virtual Kiosks | Modify R-S Virtual Kiosks | Deploy R-S Virtual Kiosks | Activate R-S Virtual Kiosks

Standard Demonstration Mode

Select an environment:

Client Account: DISNEY | Client Account No: 7145001 | User Name: John Smith

Retailer-Specific Virtual Kiosk can be Deployed to Launch from one of four different Environments:

- An HTML-Encoded Brandkey(TM) Button for launching the Retailer-Specific Virtual Kiosk from any web page once the Brandkey(TM) Button and its accompanying Virtual Kiosk Tag have been installed in the page.
- An HTML-Encoded Document for launching the Retailer-Specific Virtual Kiosk from a Word or PDF Document once the Document containing its Virtual Kiosk Tag have been downloaded.
- An HTML-Encoded Image for launching the Retailer-Specific Virtual Kiosk from any web page once the Image and its accompanying Virtual Kiosk Tag have been installed in the page.
- An HTML-Encoded Desktop Icon for launching the Retailer-Specific Virtual Kiosk from any Computer Desktop once the Desktop Icon containing its Virtual Kiosk Tag has been installed on the Computer Desktop.

Select the Environment from which the selected Retailer-Specific Virtual Kiosks will be launched:

- HTML-Encoded Brandkey (TM) Button
- HTML-Encoded Document
- HTML-Encoded Image
- HTML-Encoded Desktop Icon



FIG 49E1

597/1046



Control Panel for Generating Retailer Specific (R-S) Virtual Kiosks

Configure R-S Virtual Kiosks | Create R-S Virtual Kiosks | Modify R-S Virtual Kiosks | Deploy R-S Virtual Kiosks | Activate R-S Virtual Kiosks

Standard Demonstration Mode

Client Account: DISNEY | Client Account No: 7145001 | User Name: John Smith

Select the Retailer-Specific Virtual Kiosk(s) you wish to deploy.

Virtual Kiosk ID	Product-Specific Virtual Kiosk Name	Deploy
9909930-00939	Here will go the description of the retailer.	<input type="radio"/>
9909930-00939	Here will go the description of the retailer.	<input type="radio"/>
9909930-00939	Here will go the description of the retailer.	<input type="radio"/>
9909930-00939	Here will go the description of the retailer.	<input type="radio"/>
9909930-00939	Here will go the description of the retailer.	<input type="radio"/>

4 | Back 1 2 3 4 5 Next >>



FIG. 49E2

590/1046



Control Panel for Generating Retailer Specific (R-S) Virtual Kiosks

Configure R-S Virtual Kiosks | Create R-S Virtual Kiosks | Modify R-S Virtual Kiosks | Dep by R-S Virtual Kiosks | Activate R-S Virtual Kiosks

Standard Demonstration Mode

Client Account: DISNEY | Client Account No: 7145001 | User Name: John Smith

Select the languages in which you wish to deploy the configured Virtual Kiosks.

- Language
- English
- Spanish
- French
- German
- Japanese
- Dutch
- Italian
- Chinese
- Danish

- Selected
-
-
-
-
-
-
-
-
-
-

- Language
- Austrian
- Brazilian
- Canadian French
- Catalan
- Finnish
- Norwegian
- Portuguese
- Swedish

- Selected
-
-
-
-
-
-
-
-



FIG. 49E3A

599/1046



Control Panel for Generating Retailer Specific (R-S) Virtual Kiosks

Configure R-S Virtual Kiosks
 Create R-S Virtual Kiosks
 Modify R-S Virtual Kiosks
 Deploy R-S Virtual Kiosks
 Activate R-S Virtual Kiosks

Standard Demonstration Mode

Client Account: DISNEY Client Account No: 7145001 User Name: John Smith

Create or import the document into which you wish to embed the Retailer-Specific Virtual Kiosk tag. Click the Import button to load an existing document. The document must be in World format to load correctly.

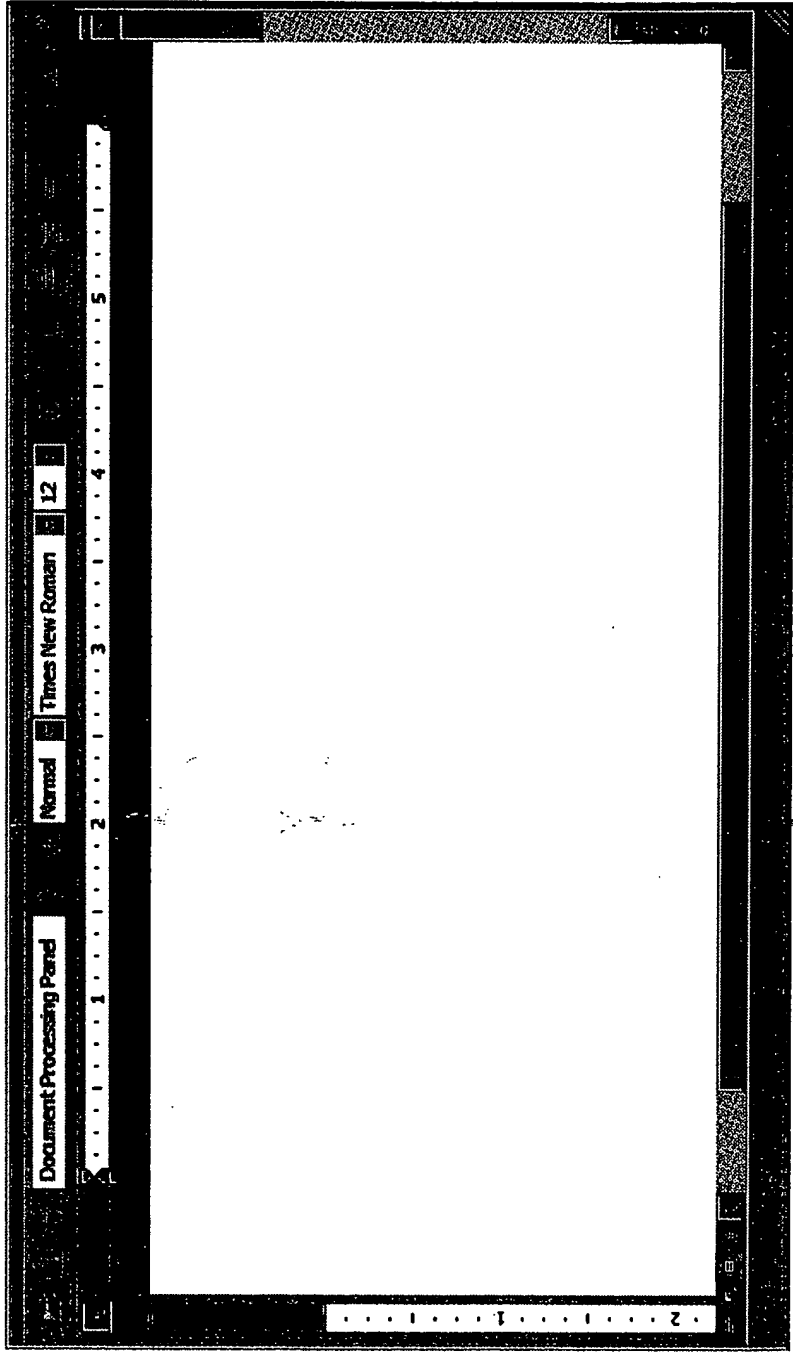

FIG. 49E3B

609/1046

600/1046



FIG. 49E3C



Control Panel for Generating Retailer Specific (R-S) Virtual Kiosks

Configure R-S Virtual Kiosks | Create R-S Virtual Kiosks | Modify R-S Virtual Kiosks | Activate R-S Virtual Kiosks

Standard Demonstration Mode

Client Account: DISNEY | Client Account No: 7145001 | User Name: John Smith

The HTML-Embedded document has been saved. Please select the format of the HTML-Embedded document you wish to deploy to the Brandkey Systems Web Server.

- Microsoft Word Document format
- Adobe PDF Document format



FIG. 49E3D

602/1046



Control Panel for Generating Retailer-Specific (R-S) Virtual Kiosks

Standard Demonstration Mode

Client Account: DISNEY | Client Account No: 7145001 | User Name: John Smith

Select the Retailer-Specific Virtual Kiosk(s) you wish to deploy.

Virtual Kiosk ID	Retailer-Specific Virtual Kiosk Name	Deploy
9909930-00939	Here will go the description of the retailer.	<input type="radio"/>
9909930-00939	Here will go the description of the retailer.	<input type="radio"/>
9909930-00939	Here will go the description of the retailer.	<input type="radio"/>
9909930-00939	Here will go the description of the retailer.	<input type="radio"/>
9909930-00939	Here will go the description of the retailer.	<input type="radio"/>

4 | Back 1 2 3 4 5 Next >



FIG. 49E3E

603/1046



Control Panel for Generating Rotator Splashid (R-S) Virtual Kiosks

Configure R-S Virtual Kiosks | Create R-S Virtual Kiosks | Modify R-S Virtual Kiosks | Deploy R-S Virtual Kiosks | Activate R-S Virtual Kiosks

Standard Demonstration Mode

Client Account: DISNEY | Client Account No: 7145001 | User Name: John Smith

Select the languages in which you wish to deploy the configured Virtual Kiosks.

Language	Selected	Language	Selected
English	<input type="checkbox"/>	Austrian	<input checked="" type="checkbox"/>
Spanish	<input checked="" type="checkbox"/>	Brazilian	<input checked="" type="checkbox"/>
French	<input checked="" type="checkbox"/>	Canadian French	<input checked="" type="checkbox"/>
German	<input checked="" type="checkbox"/>	Catalan	<input checked="" type="checkbox"/>
Japanese	<input checked="" type="checkbox"/>	Finnish	<input checked="" type="checkbox"/>
Dutch	<input checked="" type="checkbox"/>	Norwegian	<input checked="" type="checkbox"/>
Italian	<input checked="" type="checkbox"/>	Portuguese	<input checked="" type="checkbox"/>
Chinese	<input checked="" type="checkbox"/>	Swedish	<input checked="" type="checkbox"/>
Danish	<input checked="" type="checkbox"/>		

604/1046



FIG. 49E3F



Control Panel for Generating Retailer Specific (R-S) Virtual Kiosks

Configure R-S Virtual Kiosks | Create R-S Virtual Kiosks | Modify R-S Virtual Kiosks | Deploy R-S Virtual Kiosks | Activate R-S Virtual Kiosks

Standard Demonstration Mode

Upload Images for HTML-Encoded Image

Client Account: DISNEY | Client Account No: 7145001 | User Name: John Smith

Select the image to upload that you wish to use as the base image for the HTML-Encoded image you wish to create.

Base Image:

Select the image to upload that you wish to use as the secondary image to place on top of the base image for the HTML-Encoded image you wish to create.

Secondary Image:

605/1046



FIG. 49E3G



Control Panel for Generating Retailer Specific (R-S) Virtual Kiosks

Configure R-S Virtual Kiosks | Create R-S Virtual Kiosks | Modify R-S Virtual Kiosks | Deploy R-S Virtual Kiosks | Activate R-S Virtual Kiosks

Standard Demonstration Mode

Client Account: DISNEY

Client Account: DISNEY | Client Account No: 7145001 | User Name: John Smith

Use the window below to format your new image which shall be used in the HTML-Encoded Image you wish to create. You may resize both the images if you wish. The Secondary Image shall always appear on top of the Base Image.

STEP 2: CUSTOMIZE Beefy-T Shirt

FIG. 49E3H

606/1046



607/1046

FIG. 49 E3I

Control Panel for Generating Retailer Specific (R-S) Virtual Kiosks



Create R-S Virtual Kiosks | Modify R-S Virtual Kiosks | Deploy R-S Virtual Kiosks | Activate R-S Virtual Kiosks

Standard Demonstration Mode

Client Account: DISNEY

Client Account No: 7145001 | User Name: John Smith

The image you created is shown below. Please specify the area over which the consumer will click to launch the Retailer-Specific Virtual Kiosk.

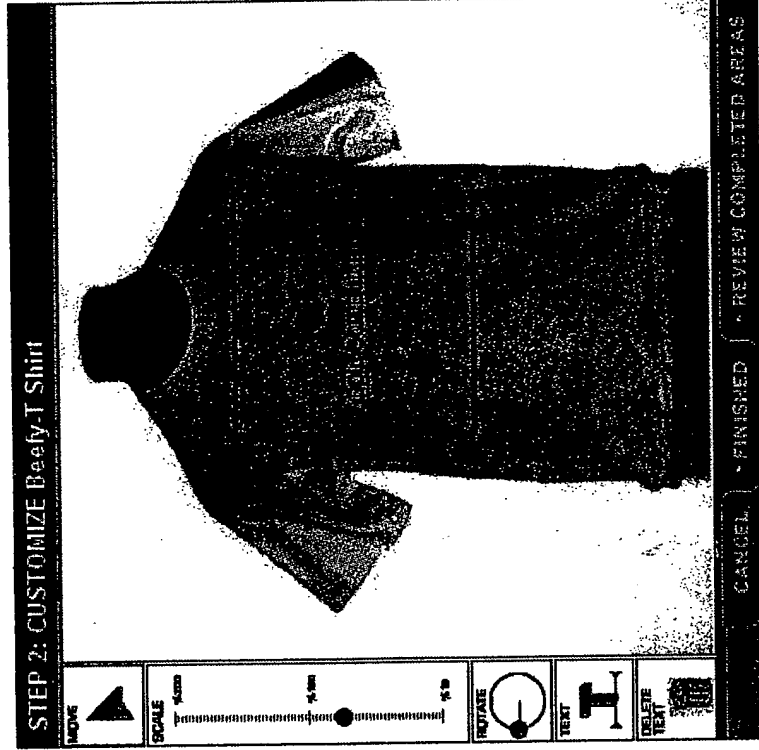

6000/1046

FIG. 49E3J



609/1046

FIG. 49 E3 K



Control Panel for Generating Retailer Specific (R-S) Virtual Kiosks

[Configure R-S Virtual Kiosks](#) |
 [Create R-S Virtual Kiosks](#) |
 [Modify R-S Virtual Kiosks](#) |
 [Deploy R-S Virtual Kiosks](#) |
 [Activate R-S Virtual Kiosks](#)

Standard Demonstration Mode

[Client Account: DISNEY | Client Account No: 7145001 | User Name: John Smith | |

Select the Retailer-Specific Virtual Kiosk(s) you wish to deploy.

Virtual Kiosk ID	Retailer-Specific Virtual Kiosk Name	Deploy
9909930-00939	Here will go the description of the retailer.	<input type="radio"/>
9909930-00939	Here will go the description of the retailer.	<input type="radio"/>
9909930-00939	Here will go the description of the retailer.	<input type="radio"/>
9909930-00939	Here will go the description of the retailer.	<input type="radio"/>
9909930-00939	Here will go the description of the retailer.	<input type="radio"/>

610/1046

4 | < Back 1 2 3 4 5 Next > | >>



FIG. 49E3L

Control Panel for Generating Retailer Specific (R-S) Virtual Kiosks



Configure R-S Virtual Kiosks | Create R-S Virtual Kiosks | Modify R-S Virtual Kiosks | Deploy R-S Virtual Kiosks | Activate R-S Virtual Kiosks

Standard Demonstration Mode

Client Account: DISNEY | Client Account No: 7145001 | User Name: John Smith

Select the languages in which you wish to deploy the configured Virtual Kiosks.

Language	Selected	Language	Selected
English	<input type="checkbox"/>	Austrian	<input checked="" type="checkbox"/>
Spanish	<input checked="" type="checkbox"/>	Brazilian	<input checked="" type="checkbox"/>
French	<input checked="" type="checkbox"/>	Canadian French	<input checked="" type="checkbox"/>
German	<input checked="" type="checkbox"/>	Catalan	<input checked="" type="checkbox"/>
Japanese	<input checked="" type="checkbox"/>	Finnish	<input checked="" type="checkbox"/>
Dutch	<input checked="" type="checkbox"/>	Norwegian	<input checked="" type="checkbox"/>
Italian	<input checked="" type="checkbox"/>	Portuguese	<input checked="" type="checkbox"/>
Chinese	<input checked="" type="checkbox"/>	Swedish	<input checked="" type="checkbox"/>
Danish	<input checked="" type="checkbox"/>		

610/1040



FIG. 49E3M



Control Panel for Generating Retailer Specific (R-S) Virtual Kiosks

Configure R-S Virtual Kiosks | Create R-S Virtual Kiosks | Modify R-S Virtual Kiosks | Deploy R-S Virtual Kiosks | Activate R-S Virtual Kiosks

Standard Demonstration Mode

UNIQUE ID OF HTML ENCODED DISPLAY

Client Account: DISNEY | Client Account No: 7145001 | User Name: John Smith

Please Upload the image you wish to use as the icon for the HTML-Encoded icon you wish to deploy.

Icon Image:

612/1046



FIG. 49 E3N



Configure R-S Virtual Kiosks

Create R-S Virtual Kiosks

Modify R-S Virtual Kiosks

Deploy R-S Virtual Kiosks

Activate R-S Virtual Kiosks

Control Panel for Generating Retailer Specific (R-S) Virtual Kiosks

Standard Demonstration Mode



Client Account: DISNEY

Client Account No: 7145001

User Name: John Smith

Here will go the License Agreement. Here will go the License Agreement. Here will go the License Agreement. Here will go the License Agreement. Here will go the License Agreement. Here will go the License Agreement. Here will go the License Agreement. Here will go the License Agreement. Here will go the License Agreement. Here will go the License Agreement.

613/1046

Agree Disagree

FIG. 49E4



Control Panel for Generating Retailer Specific (R-S) Virtual Kiosks

Configure R-S Virtual Kiosks | Create R-S Virtual Kiosks | Modify R-S Virtual Kiosks | Deploy R-S Virtual Kiosks | Activate R-S Virtual Kiosks

Standard Demonstration Mode

Common Deployment Configuration Parameters

Client Account: DISNEY | Client Account No: 7145001 | User Name: John Smith

The selected Retailer-Specific Virtual Kiosks have now been Deployed in the selected Launch Environment. To prepare the Deployed Retailer-Specific Virtual Kiosks for Installation, you must first Activate them.

614/1046

FIG. 49E5



Control Panel for Generating Retailer Specific (R-S) Virtual Kiosks

Configure R-S Virtual Kiosks | Create R-S Virtual Kiosks | Modify R-S Virtual Kiosks | Dep. by R-S Virtual Kiosks | Activate R-S Virtual Kiosks

Standard Demonstration Mode

Client Account: DISNEY | Client Account No: 7145001 | User Name: John Smith

The Virtual Kiosks below have been deployed. You can activate any of the Virtual Kiosk by checking the Active field for that Virtual Kiosk. To deactivate any Virtual Kiosk simply uncheck the Active field for the Virtual Kiosk. Click Update to save the changes.

Virtual Kiosk ID	Virtual Kiosk Name	Active
Here will go the min	Here will go the product name	<input checked="" type="checkbox"/>
Here will go the min	Here will go the product name	<input type="checkbox"/>
Here will go the min	Here will go the product name	<input type="checkbox"/>
Here will go the min	Here will go the product name	<input type="checkbox"/>
Here will go the min	Here will go the product name	<input type="checkbox"/>

4 | Back 1 2 3 4 5 Next >>

615/1046



FIG. 49 FI



Control Panel for Generating Industry Specific (I-S) Virtual Kiosks

Configure I-S Virtual Kiosks | Create I-S Virtual Kiosks | Modify I-S Virtual Kiosks | Deploy I-S Virtual Kiosks | Activate I-S Virtual Kiosks

Standard Demonstration Mode

Control Panel for Generating Industry Specific (I-S) Virtual Kiosks

Client Account: DISNEY | Client Account No: 7145001 | User Name: John Smith

Text: R.149

616/1046

FIG. 49G1



Control Panel for Generating Industry Specific (I-S) Virtual Kiosks

Configure I-S Virtual Kiosks | Create I-S Virtual Kiosks | Modify I-S Virtual Kiosks | Deploy I-S Virtual Kiosks | Activate I-S Virtual Kiosks

Standard Demonstration Mode

Get Started

Client Account: DISNEY | Client Account No: 7145001 | User Name: John Smith

Do you wish to create a Industry-Specific Virtual Kiosk for all registered products?

- Yes
- No

Do you wish to allow for creation of custom Industry-Specific Virtual Kiosks?

- Yes
- No

By default do you wish to allow installation of Industry-Specific Virtual Kiosks by Consumers?

- Yes
- No

607/1046



FIG. 49H1



Control Panel for Generating Industry-Specific (I-S) Virtual Kiosks

Configure I-S Virtual Kiosks | Create I-S Virtual Kiosks | Modify I-S Virtual Kiosks | Deploy I-S Virtual Kiosks | Activate I-S Virtual Kiosks

Standard Demonstration Mode

See Allowed Industrialists

Client Account: DISNEY | Client Account No: 7145001 | User Name: John Smith

You have selected to allow the following Industrialists to install Industry-Specific Virtual Kiosks you create. If you wish to remove an Industrialist from this list, then uncheck the Active checkbox next to their name. Click Next to save your changes. Click Add Industrialists to add additional Industrialists to this list.

Industrialist Name	City	State	Zip/Postal Code	Country	Active
Industrialist Name 1	City 1	State 1	Zip/Postal Code 1	Country 1	<input type="checkbox"/>
Industrialist Name 2	City 2	State 2	Zip/Postal Code 2	Country 2	<input type="checkbox"/>
Industrialist Name 3	City 3	State 3	Zip/Postal Code 3	Country 3	<input type="checkbox"/>
Industrialist Name 4	City 4	State 4	Zip/Postal Code 4	Country 4	<input type="checkbox"/>
Industrialist Name 5	City 5	State 5	Zip/Postal Code 5	Country 5	<input type="checkbox"/>

619/6046

Back 1 2 3 4 5 Next

Back Add Industrialists Next

FIG. 49HZ

Control Panel for Generating Industry Specific (I-S) Virtual Kiosks



Configure I-S Virtual Kiosks | Create I-S Virtual Kiosks | Modify I-S Virtual Kiosks | Deploy I-S Virtual Kiosks | Activate I-S Virtual Kiosks

Standard Demonstration Mode

Client Account: DISNEY | Client Account No: 7145001 | User Name: John Smith

Search for the Industrialists you wish to add to the list of industrialists allowed to install Industry-Specific Virtual Kiosks. You can search by Name, City, State, Zip/Postal Code and Country. Click Search to initiate the Industrialist search.

Industrialist Name:

City:

State:

Zip/Postal Code:

Country:

019/1046

Back | Search

FIG 49H3



[Configure IS Virtual Kiosks](#) |
 [Create IS Virtual Kiosks](#) |
 [Modify IS Virtual Kiosks](#) |
 [Deploy IS Virtual Kiosks](#) |
 [Activate IS Virtual Kiosks](#)

Standard Demonstration Mode

Client Account: DISNEY |
 Client Account No: 7145001 |
 User Name: John Smith

The following industrialists matched your search criteria. Check the Add Industrialist to add the industrialist to the list of industrialists allowed to install your industry-specific Virtual Kiosks. Click Next to save your changes. Click Back to redo your search.

Industrialist Name	City	State	Zip/Postal Code	Country	Add Industrialist
Industrialist Name	Norwalk	Connecticut	06903	United States	<input type="checkbox"/>
Industrialist Name	Stamford	Connecticut	06903	United States	<input type="checkbox"/>
Industrialist Name	New York	New York	06903	United States	<input type="checkbox"/>
Industrialist Name	Norwalk	Connecticut	06903	United States	<input type="checkbox"/>
Industrialist Name	Stamford	Connecticut	06903	United States	<input type="checkbox"/>

[4](#) |
 [4](#) Back |
 1 2 3 4 5 |
 Next [▶](#) |
 [▶▶](#)



FIG. 49 H4

620/1046



Central Panel for Generating Industry Specific (I-S) Virtual Kiosks

[Configure I-S Virtual Kiosks](#) |
 [Create I-S Virtual Kiosks](#) |
 [Modify I-S Virtual Kiosks](#) |
 [Deploy I-S Virtual Kiosks](#) |
 [Activate I-S Virtual Kiosks](#)

Standard Demonstration Mode

[See Forbidden Domains](#)

Client Account: DISNEY |
 Client Account No: 7145001 |
 User Name: John Smith

You have chosen to Forbid the following Domains from launching your Industry-Specific Virtual Kiosks. If you wish to remove a Domain from the list, uncheck the Forbidden checkbox. Click Next to save your changes. Click Add Domain to add another Domain to the Forbidden Domains List.

Domain Name	Forbidden
Domain Name 1	<input checked="" type="checkbox"/>
Domain Name 2	<input checked="" type="checkbox"/>
Domain Name 3	<input checked="" type="checkbox"/>
Domain Name 4	<input checked="" type="checkbox"/>
Domain Name 5	<input checked="" type="checkbox"/>

[Back](#) |
 [1](#) |
 [2](#) |
 [3](#) |
 [4](#) |
 [5](#) |
 [Next](#)

[Back](#) |
 [Add Domain](#) |
 [Finish](#)

FIG. 49H5

620/1046



Control Panel for Generating Industry-Specific (i.e.) Virtual Kiosks

Configure I-S Virtual Kiosks | Create I-S Virtual Kiosks | Modify I-S Virtual Kiosks | Deploy I-S Virtual Kiosks | Activate I-S Virtual Kiosks

Standard Demonstration Mode

Client Account: DISNEY

Client Account No: 7145001

User Name: John Smith

Enter the Root Domain Name you wish to add to the Forbidden Domain List and click Next to save it to the list. The Root Domain name is the basic Domain Name of the site you wish to block, e.g.: www.mystore.com.

Root Domain Name:

622/1046

Back Next

FIG. 49H6



Control Panel for Generating Industry Specific (IS) Virtual Kiosks

- Configure IS Virtual Kiosks
- Create IS Virtual Kiosks
- Modify IS Virtual Kiosks
- Deploy IS Virtual Kiosks
- Activate IS Virtual Kiosks
- Virtual Kiosk Settings
- Manage Brands
- Manage Virtual Kiosk
- Customer Virtual Kiosk
- Continue Virtual Kiosk Creation

Standard Demonstration Mode

Industry Specific Virtual Kiosk Display Modes

Client Account: DISNEY | Client Account No: 7145001 | User Name: John Smith

Please select the display mode that will be assigned to the Industrialist-Specific Virtual Kiosks you will be creating in this section:

- Tri-Mode Display featuring Promotional Spots + Advertising Spots + the Brand Information Network
- Dual-Mode Display featuring Advertising Spots + the Brand Information Network
- Single-Mode Display featuring the Brand Information Network

623/104.6



FIG. 49II



Control Panel for Generating Industry Specific (IS) Virtual Kiosks

Configure IS Virtual Kiosks
 Create IS Virtual Kiosks
 Modify IS Virtual Kiosks
 Deploy IS Virtual Kiosks
 Activate IS Virtual Kiosks
 Set Virtual Kiosk Parameters
 Add New Virtual Kiosk
 Edit Existing Virtual Kiosk
 Delete Existing Virtual Kiosk
 Admin
 Home

Standard Demonstration Mode

Client Account: DISNEY
 Client Account No: 7145001
 User Name: John Smith

Search for the Brand Entities to add to the Industry-Specific Virtual Kiosk. The Products associated with the selected Brand Entities will appear in the Industry-Specific Virtual Kiosk. You may search by the Trade Mark, Product Descriptor or Brand Entity Name. Enter the search criteria in the textbox, select the parameters from the dropdown list and click the Search button to initiate the Brand Entity Search.

Search Criteria:

By: Trademark

FIG. 49I2

624/1046



Control Panel for Generating Industry Specific (IS) Virtual Kiosks

[Configure IS Virtual Kiosks](#) |
 [Create IS Virtual Kiosks](#) |
 [Modify IS Virtual Kiosks](#) |
 [Activate IS Virtual Kiosks](#) |
 [Dep. of IS Virtual Kiosks](#) |
 [Admin. Virtual Kiosks](#) |
 [Admin. Virtual Kiosk Creation](#)

Standard Demonstration Mode

Select Brand Entities

Client Account: DISNEY |
 Client Account No: 7145001 |
 User Name: John Smith

Select the Brand Entities to add to the Industrialist-Specific Virtual Kiosks.

Brand Entity	Brand Entity Owner	No. of Products	Add to Kiosk
Here will go the brand entity	Here will go the brand entity owner	Here will go the No. of products	<input type="checkbox"/>
Here will go the brand entity	Here will go the brand entity owner	Here will go the No. of products	<input type="checkbox"/>
Here will go the brand entity	Here will go the brand entity owner	Here will go the No. of products	<input type="checkbox"/>
Here will go the brand entity	Here will go the brand entity owner	Here will go the No. of products	<input type="checkbox"/>
Here will go the brand entity	Here will go the brand entity owner	Here will go the No. of products	<input type="checkbox"/>

[Back](#) |
 [1](#) |
 [2](#) |
 [3](#) |
 [4](#) |
 [5](#) |
 [Next](#)

025/1046



FIG. 49I3



Control Panel for Generating Industry Specific (I-S) Virtual Kiosks

[Configures I-S Virtual Kiosks](#) |
 [Create I-S Virtual Kiosks](#) |
 [Modify I-S Virtual Kiosks](#) |
 [Activate I-S Virtual Kiosks](#) |
 [Deploy I-S Virtual Kiosks](#) |
 [Admin Virtual Kiosks](#) |
 [Generate Virtual Kiosks](#)

Standard Demonstration Mode

NEW! Industry-Specific Virtual Kiosks

Client Account: DISNEY |
 Client Account No: 7145001 |
 User Name: John Smith

Name the Industrialist-Specific Virtual Kiosk you have just created.

Virtual Kiosk ID

Here will go the virtual kiosk ID

Vendor

Here will go the vendor

Virtual Kiosk Name

|

626/1046



FIG. 49I4



Control Panel for Generating Industry Specific (i.e.) Virtual Kiosks

Configure iS Virtual Kiosks | Create iS Virtual Kiosks | Modify iS Virtual Kiosks | Deploy iS Virtual Kiosks | Activate iS Virtual Kiosks
See Virtual Kiosk Deployment | Search for Existing Virtual Kiosks | Enter New Virtual Kiosk Name | Add New Virtual Kiosk | Contribute to Virtual Kiosk

Customize Industry-Specific Virtual Kiosk

Standard Demonstration Mode

Client Account: DISNEY | Client Account No: 7145001 | User Name: John Smith

Select the Virtual Kiosk you wish to customize by clicking on the Virtual Kiosk Name. When you have finished Customizing the Industry-Specific Virtual Kiosk click the Next button.

Service-Provider-Specific Virtual Kiosk Name
Trek@Cycles 2002

Service-Provider-Specific Serial Number
09890-0989

627/1046

FIG. 49 IS



<http://www.brandkey.com/bk-deliver/m-launch-industrialist-create-5.html>
<file://www.brandkey.com/bk-deliver/TAMPcont6eiggy.htm>



Central Panel for Generating Industry Specific (I-S) Virtual Kiosks

Configure I-S Virtual Kiosks | Create I-S Virtual Kiosks | Modify I-S Virtual Kiosks | Deploy I-S Virtual Kiosks | Activate I-S Virtual Kiosks
Set Virtual Kiosk Display Mode | Manage Virtual Kiosk | Manage Virtual Kiosk | Manage Virtual Kiosk | Manage Virtual Kiosk | Manage Virtual Kiosk

Standard Demonstration Mode

Client Account: DISNEY | Client Account No: 7145001 | User Name: John Smith

Customize your Industry-Specific Virtual Kiosk by selecting the desired Customization Options. Click Preview to preview the appearance of the customized Industry-Specific Virtual Kiosk. Click Confirm to confirm the changes. Click Cancel to cancel your changes.

Customization Options

Industry Logo:

Geometric Layout: square

Surface Texture: Black

Surface Color: Black

Button Style Set: square

Button Color Set: Black

Virtual Kiosk

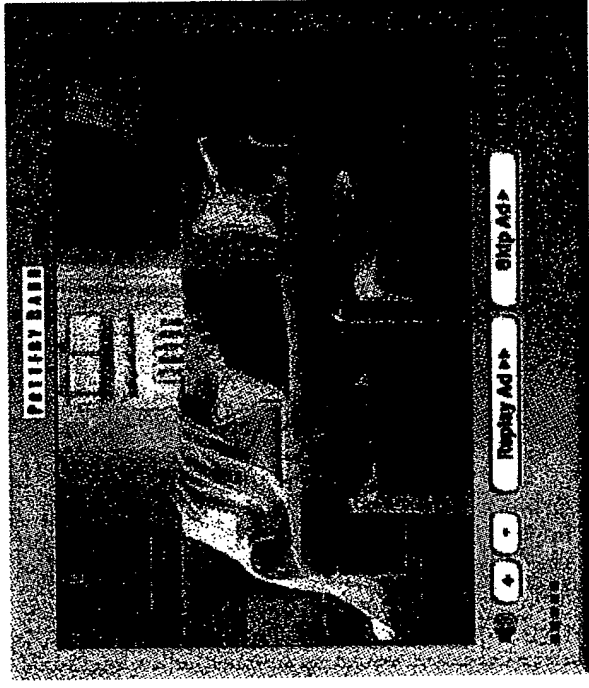

Confirm

Confirm

FIG. 49I6

6200/1046



629/1046

FIG. 49I7



Control Panel for Generating Industry Specific (IS) Virtual Kiosks

Configure IS Virtual Kiosks | Create IS Virtual Kiosks | Modify IS Virtual Kiosks | Deploy IS Virtual Kiosks | Activate IS Virtual Kiosks
Set Virtual Kiosk Display Mode | Select Virtual Kiosk | Select Brand | Name Virtual Kiosk | Create New Virtual Kiosk

Standard Demonstration Mode

Common Brandkey Industry Specific Virtual Kiosk

Client Account: DISNEY | Client Account No: 7145001 | User Name: John Smith

Congratulations, you have created the following Industry-Specific Virtual Kiosks, you can now Modify or Deploy these Industry-Specific Virtual Kiosks.

Industry-Specific Virtual Kiosk Name

- Here will go the description of the product.
- Here will go the description of the product.
- Here will go the description of the product.
- Here will go the description of the product.
- Here will go the description of the product.

Industry-Specific Virtual Kiosk Serial Number

- 0900938-78383
- 0900938-78383
- 0900938-78383
- 0900938-78383
- 0900938-78383

◀◀ | ◀ Back 1 2 3 4 5 Next ▶▶

638/1046

FIG. 4978



Control Panel for Generating Industry Specific (I-S) Virtual Kiosks

[Configure I-S Virtual Kiosks](#) |
 [Create I-S Virtual Kiosks](#) |
 [Modify I-S Virtual Kiosks](#) |
 [Deploy I-S Virtual Kiosks](#) |
 [Activate I-S Virtual Kiosks](#)

Standard Demonstration Mode

Select the Industry Specific Virtual Kiosk

Client Account: DISNEY |
 Client Account No: 7145001 |
 User Name: John Smith

Select the Industry-Specific Virtual Kiosks you wish to modify by clicking on the Virtual Kiosk ID Number.

Virtual Kiosks ID Number	Store Location	Virtual Kiosk Name	Deployed	Active
9909930-00939	Here will go the store location	Virtual Kiosk name	✓	✓
9909930-00939	Here will go the store location	Virtual Kiosk name	✓	✓
9909930-00939	Here will go the store location	Virtual Kiosk name	✓	X
9909930-00939	Here will go the store location	Virtual Kiosk name	✓	✓
9909930-00939	Here will go the store location	Virtual Kiosk name	✓	X

◀◀ | ◀ Back | 1 2 3 4 5 | Next ▶▶

631/1046

FIG. 49 J I



Control Panel for Generating Industry Specific (iS) Virtual Kiosks

Configure iS Virtual Kiosks | Create iS Virtual Kiosks | Modify iS Virtual Kiosks | Deploy iS Virtual Kiosks | Activate iS Virtual Kiosks

Standard Demonstration Mode

Client Account: DISNEY | Client Account No: 7145001 | User Name: John Smith

Update the information for the selected Virtual Kiosk. Click Update to save your changes. Click Update Brands to update the list of Brand Entities associated with the selected Virtual Kiosk.

Virtual Kiosk Serial Number: 09009876-09

Virtual Kiosk Name:

- Display Mode:
- Tri-Mode Display comprising: Advertising Spot Display Mode, Promotional Spot Display Mode, and Brand Information Network Display Mode
 - Dual-Mode Display comprising: Advertising Spot Display Mode, and Brand Information Network Display Mode
 - Uni-Mode Display comprising: Brand Information Network Display Mode

Allow Consumer Installation: Yes No

Virtual Kiosk Status: Deployed-Activated



FIG. 4952

632/1046



Central Panel for Operating Industry Specific () Virtual Kiosks

Configure I-S Virtual Kiosks | Create I-S Virtual Kiosks | Modify I-S Virtual Kiosks | Deploy I-S Virtual Kiosks | Activate I-S Virtual Kiosks

Standard Demonstration Mode

Modify I-S Industry Specific Virtual Kiosk

Client Account: DISNEY | Client Account No: 7145001 | User Name: John Smith

The Industry-Specific Virtual Kiosk [Name] has been modified. Please review and confirm your modifications. If any information is not correct then click Edit to correct and update. Click Update Brands to update the list of Brand Entities associated with the selected Virtual Kiosk.

Virtual Kiosk Serial Number: 09009876-09

Virtual Kiosk Name: Virtual Kiosk Name

Virtual Kiosk Mode: Promo-Spot Display Mode

Allow Retailer Installation: Yes

Allow Industrialist Installation: No

Allow Consumer Installation: Yes

Virtual Kiosk Status: Deployed-Activated

633/1046

EDIT | UPDATE BRANDS | GO BACK

FIG. 49J3



Control Panel for Generating Industry Specific 03 Virtual Kiosks

Configure I-S Virtual Kiosks | Create I-S Virtual Kiosks | Modify I-S Virtual Kiosks | Activate I-S Virtual Kiosks

Standard Demonstration Mode

Client Account: DISNEY | Client Account No: 7145001 | User Name: John Smith

Please review the list of Brand Entities assigned to the Industry-Specific Virtual Kiosks. To remove an associated Brand Entity from the Virtual Kiosk, simply uncheck the Active checkbox. To add new Brand Entities to the Virtual Kiosk list, click the Add Brands button. If you do not wish to add any more, click Finish to confirm the Virtual Kiosk Brand Entity list.

Brand Entity Name	Brand Entity Owner	Trade Mark (TM)	Product Descriptor (PD)	Selected
Here will go the Brand Entity	Here will go the Brand Entity Owner	Here will go the trade mark	Here will go the description of the product. Here will go the description of the product.	<input checked="" type="checkbox"/>
Here will go the Brand Entity	Here will go the Brand Entity Owner	Here will go the trade mark	Here will go the description of the product. Here will go the description of the product.	<input checked="" type="checkbox"/>
Here will go the Brand Entity	Here will go the Brand Entity Owner	Here will go the trade mark	Here will go the description of the product. Here will go the description of the product.	<input checked="" type="checkbox"/>
Here will go the Brand Entity	Here will go the Brand Entity Owner	Here will go the trade mark	Here will go the description of the product. Here will go the description of the product.	<input checked="" type="checkbox"/>
Here will go the Brand Entity	Here will go the Brand Entity Owner	Here will go the trade mark	Here will go the description of the product. Here will go the description of the product.	<input checked="" type="checkbox"/>

4 | 4 Back 1 2 3 4 5 Next | >>

Add Brand Finish

FIG. 49JH

634/1046



Central Panel for Generating Industry Specific (IS) Virtual Kiosks

Configure IS Virtual Kiosks | Create IS Virtual Kiosks | Modify IS Virtual Kiosks | Deploy IS Virtual Kiosks | Activate IS Virtual Kiosks

Standard Demonstration Mode

Search for Brand Entities

Client Account: DISNEY | Client Account No: 7145001 | User Name: John Smith

Search for the Brand Entities to add to the Industry-Specific Virtual Kiosks. You may search by the Trade Mark, Product Descriptor or Brand Entity Name. Enter the search criteria in the textbox, select the parameters from the dropdown list and click the Search button to initiate the Brand Entity search.

Search for: By: TM

Search

FIG. 49J5

635/1046



Control Panel for Generating Industry Specific (I-S) Virtual Kiosks

Configure I-S Virtual Kiosks

Create I-S Virtual Kiosks

Modify I-S Virtual Kiosks

Deploy I-S Virtual Kiosks

Activate I-S Virtual Kiosks

Standard Demonstration Mode

Select Brand Entity

Client Account: DISNEY

Client Account No: 7145001

User Name: John Smith

Select the Brand Entities to add to the Industrialist-Specific Virtual Kiosks.

Brand Entity Name	Brand Entity Owner	Trade Mark (TM)	Product Descriptor (PD)	Add to Kiosk
Here will go the Brand Entity	Here will go the Brand Entity Owner	Here will go the trade mark	Here will go the description of the product. Here will go the description of the product.	<input type="checkbox"/>
Here will go the Brand Entity	Here will go the Brand Entity Owner	Here will go the trade mark	Here will go the description of the product. Here will go the description of the product.	<input type="checkbox"/>
Here will go the Brand Entity	Here will go the Brand Entity Owner	Here will go the trade mark	Here will go the description of the product. Here will go the description of the product.	<input type="checkbox"/>
Here will go the Brand Entity	Here will go the Brand Entity Owner	Here will go the trade mark	Here will go the description of the product. Here will go the description of the product.	<input type="checkbox"/>
Here will go the Brand Entity	Here will go the Brand Entity Owner	Here will go the trade mark	Here will go the description of the product. Here will go the description of the product.	<input type="checkbox"/>

4 | Back 1 2 3 4 5 Next >



FIG. 49 J6

636/1046



Central Panel for Generating Industry Specific (IS) Virtual Kiosks

[Configure IS Virtual Kiosks](#) |
 [Create IS Virtual Kiosks](#) |
 [Modify IS Virtual Kiosks](#) |
 [Deploy IS Virtual Kiosks](#) |
 [Activate IS Virtual Kiosks](#)

Standard Demonstration Mode

Client Account: DISNEY |
 Client Account No: 7145001 |
 User Name: John Smith

Industry-Specific Virtual Kiosk has been modified. Please review and confirm the information below. If any information is not correct then click Edit to correct and update.

Name: Name goes here
ID: 0944930-9388399
Mode: Ad-Spot Display Mode

List of Brand Entities

Brand Entity Name	Brand Entity Owner	Trade Mark (TM)	Product Descriptor (PD)
Here will go the Brand Entity Owner	Here will go the Brand Entity Owner	Here will go the trade mark	Here will go the description of the product. Here will go the description of the product.
Here will go the Brand Entity Owner	Here will go the Brand Entity Owner	Here will go the trade mark	Here will go the description of the product. Here will go the description of the product.
Here will go the Brand Entity Owner	Here will go the Brand Entity Owner	Here will go the trade mark	Here will go the description of the product. Here will go the description of the product.
Here will go the Brand Entity Owner	Here will go the Brand Entity Owner	Here will go the trade mark	Here will go the description of the product. Here will go the description of the product.
Here will go the Brand Entity Owner	Here will go the Brand Entity Owner	Here will go the trade mark	Here will go the description of the product. Here will go the description of the product.

639/1046

[Back](#) |
 [1](#) |
 [2](#) |
 [3](#) |
 [4](#) |
 [5](#) |
 [Next](#)



FIG. 49 J7



Central Panel for Generating Industry-Specific (I-S) Virtual Kiosks

Configure I-S Virtual Kiosks
 Create I-S Virtual Kiosks
 Modify I-S Virtual Kiosks
 Deploy I-S Virtual Kiosks
 Activate I-S Virtual Kiosks

Standard Demonstration Mode

SELECT AN ENVIRONMENT

Client Account: DISNEY
 Client Account No: 7145001
 User Name: John Smith

Industry-Specific Virtual Kiosk can be Deployed to Launch from one of four different Environments:

- An HTML-Encoded Brandkey(TM) Button for launching the Industry-Specific Virtual Kiosk from any web page once the Brandkey(TM) Button and its accompanying Virtual Kiosk Tag have been installed in the page.
- An HTML-Encoded Document for launching the Industry-Specific Virtual Kiosk from a Word or PDF Document once the Document containing its Virtual Kiosk Tag have been downloaded.
- An HTML-Encoded Image for launching the Industry-Specific Virtual Kiosk from any web page once the Image and its accompanying Virtual Kiosk Tag have been installed in the page.
- An HTML-Encoded Desktop Icon for launching the Industry-Specific Virtual Kiosk from any Computer Desktop once the Desktop Icon containing its Virtual Kiosk Tag has been installed on the Computer Desktop.

Select the Environment from which the selected Industry-Specific Virtual Kiosks will be launched:

- HTML-Encoded Brandkey (TM) Button
- HTML-Encoded Document
- HTML-Encoded Image
- HTML-Encoded Desktop Icon

630/1046



FIG. 49KI



Central Panel for Generating Industry-Specific (I-S) Virtual Kiosks

[Configure I-S Virtual Kiosks](#) |
 [Create I-S Virtual Kiosks](#) |
 [Modify I-S Virtual Kiosks](#) |
 [Deploy I-S Virtual Kiosks](#) |
 [Activate I-S Virtual Kiosks](#)

Standard Demonstration Mode

Client Account: DISNEY |
 Client Account No: 7145001 |
 User Name: John Smith

Select the Industry-Specific Virtual Kiosk(s) you wish to deploy.

Virtual Kiosk ID	Industry-Specific Virtual Kiosk Name	Deploy
9909930-00939	Here will go the description of the retailer.	<input type="radio"/>
9909930-00939	Here will go the description of the retailer.	<input type="radio"/>
9909930-00939	Here will go the description of the retailer.	<input type="radio"/>
9909930-00939	Here will go the description of the retailer.	<input type="radio"/>
9909930-00939	Here will go the description of the retailer.	<input type="radio"/>

639/1046

◀ Back 1 2 3 4 5 Next ▶▶▶



FIG. 49KZ



Control Panel For Generating Industry Specific (U.S.) Virtual Kiosks

Configure I-S Virtual Kiosks | Create I-S Virtual Kiosks | Modify I-S Virtual Kiosks | Deploy I-S Virtual Kiosks | Activate I-S Virtual Kiosks

Standard Demonstration Mode

Client Account: DISNEY | Client Account No: 7145001 | User Name: John Smith

Select the languages in which you wish to deploy the configured Virtual Kiosks.

Language	Selected	Language	Selected
English	<input type="checkbox"/>	Austrian	<input checked="" type="checkbox"/>
Spanish	<input checked="" type="checkbox"/>	Brazilian	<input checked="" type="checkbox"/>
French	<input checked="" type="checkbox"/>	Canadian French	<input checked="" type="checkbox"/>
German	<input checked="" type="checkbox"/>	Catalan	<input checked="" type="checkbox"/>
Japanese	<input checked="" type="checkbox"/>	Finnish	<input checked="" type="checkbox"/>
Dutch	<input checked="" type="checkbox"/>	Norwegian	<input checked="" type="checkbox"/>
Italian	<input checked="" type="checkbox"/>	Portuguese	<input checked="" type="checkbox"/>
Chinese	<input checked="" type="checkbox"/>	Swedish	<input checked="" type="checkbox"/>
Danish	<input checked="" type="checkbox"/>		

640/1046



FIG. 49K3A



Control Panel for Generating Industry Specific (I-S) Virtual Kiosks

Configures I-S Virtual Kiosks
 Create I-S Virtual Kiosks
 Modify I-S Virtual Kiosks
 Deploy I-S Virtual Kiosks
 Activate I-S Virtual Kiosks

Standard Demonstration Mode

SEARCH HERE FOR DOCUMENTS

Client Account: DISNEY
 Client Account No: 7145001
 User Name: John Smith

Create or import the document into which you wish to embed the Industry-Specific Virtual Kiosk tag. Click the Import button to load an existing document. The document must be in World format to load correctly.

641/1046

FIG. 49K3B



64211046

FIG. 49K3C



Control Panel for Generating Industry-Specific (I-S) Virtual Kiosks

Configure I-S Virtual Kiosks
 Create I-S Virtual Kiosks
 Modify I-S Virtual Kiosks
 Deploy I-S Virtual Kiosks
 Activate I-S Virtual Kiosks

Standard Demonstration Mode

Client Account: DISNEY
 Client Account No: 7145001
 User Name: John Smith

The HTML-Embedded document has been saved. Please select the format of the HTML-Embedded document you wish to deploy to the Brandkey Systems Web Server.

- Microsoft Word Document format
- Adobe PDF Document format

64311046



FIG. 49 K3D



Control Panel for Generating Industry Specific (I-S) Virtual Kiosks

Configure I-S Virtual Kiosks | Create I-S Virtual Kiosks | Modify I-S Virtual Kiosks | Deploy I-S Virtual Kiosks | Activate I-S Virtual Kiosks

Standard Demonstration Mode

Select Industry-Specific Virtual Kiosk(s)

Client Account: DISNEY | Client Account No: 7145001 | User Name: John Smith

Select the Industry-Specific Virtual Kiosk(s) you wish to deploy.

Virtual Kiosk ID	Industry-Specific Virtual Kiosk Name	Deploy
9909930-00939	Here will go the description of the retailer.	<input type="radio"/>
9909930-00939	Here will go the description of the retailer.	<input type="radio"/>
9909930-00939	Here will go the description of the retailer.	<input type="radio"/>
9909930-00939	Here will go the description of the retailer.	<input type="radio"/>
9909930-00939	Here will go the description of the retailer.	<input type="radio"/>

644/1046

◀ Back 1 2 3 4 5 Next ▶▶



FIG. 49K3E



Control Panel for Generating Industry Specific (US) Virtual Kiosks

Configure I-S Virtual Kiosks | Create I-S Virtual Kiosks | Modify I-S Virtual Kiosks | Deploy I-S Virtual Kiosks | Activate I-S Virtual Kiosks

Standard Demonstration Mode

Client Account: DISNEY | Client Account No: 7145001 | User Name: John Smith

Select the languages in which you wish to deploy the configured Virtual Kiosks.

Language	Selected	Language	Selected
English	<input type="checkbox"/>	Austrian	<input checked="" type="checkbox"/>
Spanish	<input checked="" type="checkbox"/>	Brazilian	<input checked="" type="checkbox"/>
French	<input checked="" type="checkbox"/>	Canadian French	<input checked="" type="checkbox"/>
German	<input checked="" type="checkbox"/>	Catalan	<input checked="" type="checkbox"/>
Japanese	<input checked="" type="checkbox"/>	Finnish	<input checked="" type="checkbox"/>
Dutch	<input checked="" type="checkbox"/>	Norwegian	<input checked="" type="checkbox"/>
Italian	<input checked="" type="checkbox"/>	Portuguese	<input checked="" type="checkbox"/>
Chinese	<input checked="" type="checkbox"/>	Swedish	<input checked="" type="checkbox"/>
Danish	<input checked="" type="checkbox"/>		

645:1046



FIG. 49K3F

Brandkey
deliver

Control Panel for Generating Industry Specific (I-S) Virtual Kiosks

Configure I-S Virtual Kiosks | Create I-S Virtual Kiosks | Modify I-S Virtual Kiosks | Deploy I-S Virtual Kiosks | Activate I-S Virtual Kiosks

Standard Demonstration Mode

Client Account: DISNEY | Client Account No: 7145001 | User Name: John Smith

Select the image to upload that you wish to use as the base image for the HTML-Encoded Image you wish to create.

Base Image:

Select the image to upload that you wish to use as the secondary image to place on top of the base image for the HTML-Encoded Image you wish to create.

Secondary Image:

646/1046



FIG. 49K39



Control Panel for Generating Industry Specific (I-S) Virtual Kiosks

Configures I-S Virtual Kiosks | Create I-S Virtual Kiosks | Modify I-S Virtual Kiosks | Deploy I-S Virtual Kiosks | Activate I-S Virtual Kiosks

Standard Demonstration Mode

CLIENT ACCOUNT INFORMATION

Client Account: DISNEY | Client Account No: 7145001 | User Name: John Smith

Use the window below to format your new image which shall be used in the HTML-Encoded image you wish to create. You may resize both the images if you wish. The Secondary image shall always appear on top of the Base image.

STEP 2: CUSTOMIZE Beely-T Shirt

CANCEL FINISHED REVIEW COMPLETED AREAS

FIG. 49K3H

64711046



648/1046

FIG. 49 K3I



Control Panel for Generating Industry Specific (1-3) Virtual Kiosks

Configure I-S Virtual Kiosks | Create I-S Virtual Kiosks | Modify I-S Virtual Kiosks | Deploy I-S Virtual Kiosks | Activate I-S Virtual Kiosks

Standard Demonstration Mode

SEARCH FOR MY SOURCE USING GOOGLE

Client Account: DISNEY | Client Account No: 7145001 | User Name: John Smith

The image you created is shown below. Please specify the area over which the consumer will click to launch the Industry-Specific Virtual Kiosk.

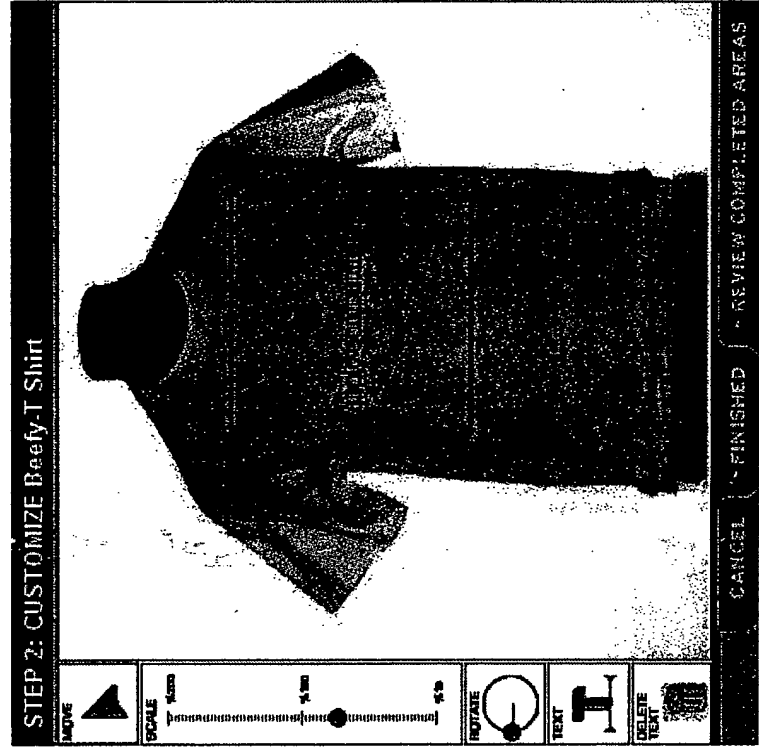

649/1046

FIG. 49 KB.J



650/1040

FIG. 49 K3 K



Control Panel for Generating Industry-Specific (I-S) Virtual Kiosks

Configure I-S Virtual Kiosks | Create I-S Virtual Kiosks | Modify I-S Virtual Kiosks | Deploy I-S Virtual Kiosks | Activate I-S Virtual Kiosks

Standard Demonstration Mode

Select Industry-Specific Virtual Kiosks

Client Account: DISNEY | Client Account No: 7145001 | User Name: John Smith

Select the Industry-Specific Virtual Kiosk(s) you wish to deploy.

Virtual Kiosk ID	Industry-Specific Virtual Kiosk Name	Deploy
9909930-00939	Here will go the description of the retailer.	<input type="radio"/>
9909930-00939	Here will go the description of the retailer.	<input type="radio"/>
9909930-00939	Here will go the description of the retailer.	<input type="radio"/>
9909930-00939	Here will go the description of the retailer.	<input type="radio"/>
9909930-00939	Here will go the description of the retailer.	<input type="radio"/>

Navigation buttons: Back, 1, 2, 3, 4, 5, Next

651/1046



FIG. 49 K3L



Control Panel for Generating Industry Specific (i.e) Virtual Kiosks

Configure I-S Virtual Kiosks | Create I-S Virtual Kiosks | Modify I-S Virtual Kiosks | Deploy I-S Virtual Kiosks | Activate I-S Virtual Kiosks

Standard Demonstration Mode

Client Account: DISNEY | Client Account No: 7145001 | User Name: John Smith

Select the languages in which you wish to deploy the configured Virtual Kiosks.

Language	Selected	Language	Selected
English	<input type="checkbox"/>	Austrian	<input checked="" type="checkbox"/>
Spanish	<input checked="" type="checkbox"/>	Brazilian	<input checked="" type="checkbox"/>
French	<input checked="" type="checkbox"/>	Canadian French	<input checked="" type="checkbox"/>
German	<input checked="" type="checkbox"/>	Catalan	<input checked="" type="checkbox"/>
Japanese	<input checked="" type="checkbox"/>	Finnish	<input checked="" type="checkbox"/>
Dutch	<input checked="" type="checkbox"/>	Norwegian	<input checked="" type="checkbox"/>
Italian	<input checked="" type="checkbox"/>	Portuguese	<input checked="" type="checkbox"/>
Chinese	<input checked="" type="checkbox"/>	Swedish	<input checked="" type="checkbox"/>
Danish	<input checked="" type="checkbox"/>		

652/1046

Back Next

FIG. 49 K3M



Control Panel for Generating Industry Specific (i3) Virtual Kiosks

Configure i3 Virtual Kiosks | Create i3 Virtual Kiosks | Modify i3 Virtual Kiosks | Deploy i3 Virtual Kiosks | Activate i3 Virtual Kiosks

Standard Demonstration Mode

Upload Image for HTML-Encoded Deployment

Client Account: DISNEY | Client Account No: 7145001 | User Name: John Smith

Please Upload the image you wish to use as the icon for the HTML-Encoded Icon you wish to deploy.

Icon Image:

653/1046

BACK NEXT

FIG. 49K3N



Control Panel for Generating Industry Specific (I-S) Virtual Kiosks

Configure I-S Virtual Kiosks | Create I-S Virtual Kiosks | Modify I-S Virtual Kiosks | Deploy I-S Virtual Kiosks | Activate I-S Virtual Kiosks

Standard Demonstration Mode

Confirm Deployment of Industry Specific Virtual Kiosks

Client Account: DISNEY | Client Account No: 7145001 | User Name: John Smith

The selected Industry-Specific Virtual Kiosks have now been Deployed in the selected Launch Environment. To prepare the Deployed Industry-Specific Virtual Kiosks for Installation, you must first Activate them.

655/1046

FIG. 49K5



Control Panel for Generating Industry Specific (1-3) Virtual Kiosks

Configure 1-3 Virtual Kiosks | Create 1-3 Virtual Kiosks | Modify 1-3 Virtual Kiosks | Deploy 1-3 Virtual Kiosks | Activate 1-3 Virtual Kiosks

Standard Demonstration Mode

Control Panel for Activating Industry Specific Virtual Kiosks

Client Account: DISNEY | Client Account No: 7145001 | User Name: John Smith

The Virtual Kiosks below have been deployed. You can activate any of the Virtual Kiosk by checking the Active field for that Virtual Kiosk. To deactivate any Virtual Kiosk simply uncheck the Active field for the Virtual Kiosk. Click Update to save the changes.

Virtual Kiosk ID	Virtual Kiosk Name	Active
Here will go the min	Here will go the product name	<input checked="" type="checkbox"/>
Here will go the min	Here will go the product name	<input type="checkbox"/>
Here will go the min	Here will go the product name	<input type="checkbox"/>
Here will go the min	Here will go the product name	<input type="checkbox"/>
Here will go the min	Here will go the product name	<input type="checkbox"/>

« Back 1 2 3 4 5 Next »

656/1046

Activate

FIG. 49 LI



Control Panel for Generating Corporate-Specific C-S Virtual Kiosks

Configure C-S Virtual Kiosks | Create C-S Virtual Kiosks | Modify C-S Virtual Kiosks | Deploy C-S Virtual Kiosks | Activate C-S Virtual Kiosks

Standard Demonstration Mode

Control Panel for Generating Corporate-Specific C-S Virtual Kiosks

Client Account: DISNEY | Client Account No: 7145001 | User Name: John Smith

Text R.149

657/1046

FIG. 49M1



Control Panel for Generating Corporate-Specific (C-S) Virtual Kiosks

Configure C-S Virtual Kiosks
 Create C-S Virtual Kiosks
 Modify C-S Virtual Kiosks
 Deploy C-S Virtual Kiosks
 Activate C-S Virtual Kiosks

Standard Demonstration Mode

See Standard Configuration

Client Account: DISNEY Client Account No: 7145001 User Name: John Smith

Do you wish to create a Corporate-Specific Virtual Kiosk for all registered products?

- Yes
- No

Do you wish to allow for creation of custom Corporate-Specific Virtual Kiosks?

- Yes
- No

By default do you wish to allow installation of Corporate-Specific Virtual Kiosks by Consumers?

- Yes
- No

650/1046



FIG. 49N1



Control Panel for Generating Corporate Specific (C-S) Virtual Kiosks

Configure C-S Virtual Kiosks | Create C-S Virtual Kiosks | Modify C-S Virtual Kiosks | Deploy C-S Virtual Kiosks | Activate C-S Virtual Kiosks

Standard Demonstration Mode

Client Account: DISNEY | Client Account No: 7145001 | User Name: John Smith

You have selected to allow the following Industrialists to install Corporate-Specific Virtual Kiosks you create. If you wish to remove an Industrialist from this list, then uncheck the Active checkbox next to their name. Click Next to save your changes. Click Add Industrialist to add additional Industrialist to this list.

Industrialist Name	City	State	Zip/Postal Code	Country	Active
Industrialist Name 1	City 1	State 1	Zip/Postal Code 1	Country 1	<input type="checkbox"/>
Industrialist Name 2	City 2	State 2	Zip/Postal Code 2	Country 2	<input type="checkbox"/>
Industrialist Name 3	City 3	State 3	Zip/Postal Code 3	Country 3	<input type="checkbox"/>
Industrialist Name 4	City 4	State 4	Zip/Postal Code 4	Country 4	<input type="checkbox"/>
Industrialist Name 5	City 5	State 5	Zip/Postal Code 5	Country 5	<input type="checkbox"/>

Navigation: Back 1 2 3 4 5 Next

Buttons: Back, Add Industrialist, Next

FIG. 49N2

659/1046



Control Panel for Generating Corporate-Specific (C-S) Virtual Kiosks

Configure C-S Virtual Kiosks | Create C-S Virtual Kiosks | Modify C-S Virtual Kiosks | Deploy C-S Virtual Kiosks | Activate C-S Virtual Kiosks

Standard Demonstration Mode

[Search for Industrialists](#)

Client Account: DISNEY | Client Account No: 7145001 | User Name: John Smith

Search for the Industrialist you wish to add to the list of Industrialist allowed to install Corporate-Specific Virtual Kiosks. You can search by Name, City, State, Zip/Postal Code and Country. Click Search to initiate the Industrialist search.

Industrialist Name:

City:

State:

Zip/Postal Code:

Country:

660/1046

[Back](#) [Search](#)

FIG. 49N3



Control Panel for Generating Corporate-Specific (C-S) Virtual Kiosks

Configure C-S Virtual Kiosks | Create C-S Virtual Kiosks | Modify C-S Virtual Kiosks | Deploy C-S Virtual Kiosks | Activate C-S Virtual Kiosks

Standard Demonstration Mode

[Select Industrialist](#)

Client Account: DISNEY

Client Account No: 7145001

User Name: John Smith

The following Industrialists matched your search criteria. Check the Add corporate to add the Industrialist to the list of Industrialists allowed to install your Corporate-Specific Virtual Kiosks. Click Next to save your changes. Click Back to redo your search.

Industrialist Name	City	State	Zip/Postal Code	Country	Add Industrialist
Industrialist Name	Norwalk	Connecticut	06903	United States	<input type="checkbox"/>
Industrialist Name	Stamford	Connecticut	06903	United States	<input type="checkbox"/>
Industrialist Name	New York	New York	06903	United States	<input type="checkbox"/>
Industrialist Name	Norwalk	Connecticut	06903	United States	<input type="checkbox"/>
Industrialist Name	Stamford	Connecticut	06903	United States	<input type="checkbox"/>

1061/1046

◀◀ | ◀ Back 1 2 3 4 5 Next ▶▶

Back Next

FIG. 49N4



Standard Demonstration Mode

FORBIDDEN DOMAINS

Client Account: DISNEY | Client Account No: 7145001 | User Name: John Smith

You have chosen to Forbid the following Domains from launching your Corporate-Specific Virtual Kiosks. If you wish to remove a Domain from the list, uncheck the Forbidden checkbox. Click Next to save your changes. Click Add Domain to add another Domain to the Forbidden Domains List.

Domain Name	Forbidden
Domain Name 1	<input checked="" type="checkbox"/>
Domain Name 2	<input checked="" type="checkbox"/>
Domain Name 3	<input checked="" type="checkbox"/>
Domain Name 4	<input checked="" type="checkbox"/>
Domain Name 5	<input checked="" type="checkbox"/>

« | « Back 1 2 3 4 5 Next » | »

Back Add Domain Finish

FIG. 49N5

662/1040



Control Panel for Generating Corporate Specific (C-S) Virtual Kiosks

Configure C-S Virtual Kiosks | Create C-S Virtual Kiosks | Modify C-S Virtual Kiosks | Deploy C-S Virtual Kiosks | Activate C-S Virtual Kiosks

Standard Demonstration Mode

ADD FORBIDDEN DOMAIN

Client Account: DISNEY | Client Account No: 7145001 | User Name: John Smith

Enter the Root Domain Name you wish to add to the Forbidden Domain List and click Next to save it to the list. The Root Domain name is the basic Domain Name of the site you wish to block, e.g.: www.mystore.com.

Root Domain Name:

663/1046



FIG. 49N6



Control Panel for Generating Corporate Spots (C-S) Virtual Kiosks

Configure C-S Virtual Kiosks | Create C-S Virtual Kiosks | Modify C-S Virtual Kiosks | Deploy C-S Virtual Kiosks | Activate C-S Virtual Kiosks

Standard Demonstration Mode

Set Corporate-Specific Virtual Kiosk Display Mode

Client Account: DISNEY | Client Account No: 7145001 | User Name: John Smith

Please select the display mode that will be assigned to the corporate-specific Virtual Kiosks you will be creating in this section:

- Tri-Mode Display featuring Promotional Spots + Advertising Spots + the Brand Information Network
- Dual-Mode Display featuring Advertising Spots + the Brand Information Network
- Single-Mode Display featuring the Brand Information Network

669/1046

Next

FIG. 4901

Standard Demonstration Mode

Search for Brand Entities

Client Account: DISNEY |
 Client Account No: 7145001 |
 User Name: John Smith

Search for the Brand Entities to add to the Corporate-Specific Virtual Kiosk. The Products associated with the selected Brand Entities will appear in the Corporate-Specific Virtual Kiosk. You may search by the Trade Mark, Product Descriptor or Brand Entity Name. Enter the search criteria in the textbox, select the parameters from the dropdown list and click the Search button to initiate the Brand Entity Search.

Search Criteria:

By: **Trademark**

665/1046

FIG. 4902



Control Panel for Generating Corporate Specific (C-S) Virtual Kiosks

Configure C-S Virtual Kiosks | Create C-S Virtual Kiosks | Modify C-S Virtual Kiosks | Deploy C-S Virtual Kiosks | Activate C-S Virtual Kiosks

Standard Demonstration Mode

Select Brand Entities

Client Account: DISNEY | Client Account No: 7145001 | User Name: John Smith

Select the Brand Entities to add to the Corporate-Specific Virtual Kiosks.

Brand Entity	Brand Entity Owner	No. of Products	Add to Kiosk
Here will go the brand entity	Here will go the brand entity owner	Here will go the No. of products	<input type="checkbox"/>
Here will go the brand entity	Here will go the brand entity owner	Here will go the No. of products	<input type="checkbox"/>
Here will go the brand entity	Here will go the brand entity owner	Here will go the No. of products	<input type="checkbox"/>
Here will go the brand entity	Here will go the brand entity owner	Here will go the No. of products	<input type="checkbox"/>
Here will go the brand entity	Here will go the brand entity owner	Here will go the No. of products	<input type="checkbox"/>

666/1046

Navigation: Back, 1, 2, 3, 4, 5, Next

Back Next

FIG. 4903



Control Panel for Generating Corporate-Specific (C-S) Virtual Kiosks

Configure C-S Virtual Kiosks | Create C-S Virtual Kiosks | Modify C-S Virtual Kiosks | Deploy C-S Virtual Kiosks | Activate C-S Virtual Kiosks

Standard Demonstration Mode

NAME: CORPORATE-SPECIFIC VIRTUAL KIOSKS

Client Account: DISNEY | Client Account No: 7145001 | User Name: John Smith

Name the Corporate-Specific Virtual Kiosk you have just created.

Virtual Kiosk ID: Here will go the virtual kiosk ID
Vendor: Here will go the vendor
Virtual Kiosk Name: [Empty text box]

Navigation: << | < Back 1 2 3 4 5 Next > | >>

Back Next

FIG. 4904

607/1046



Control Panel for Generating Corporate-Specific (C-S) Virtual Kiosks

Configure C-S Virtual Kiosks | Create C-S Virtual Kiosks | Modify C-S Virtual Kiosks | Deploy C-S Virtual Kiosks | Activate C-S Virtual Kiosks

Standard Demonstration Mode

Customize Corporate-Specific Virtual Kiosk

Client Account: DISNEY | Client Account No: 7145001 | User Name: John Smith

Select the Virtual Kiosk you wish to customize by clicking on the Virtual Kiosk Name. When you have finished Customizing the Corporate-Specific Virtual Kiosk click the Next button.

Corporate-Specific Virtual Kiosk Name
Irek@Cycles.2002

Corporate-Specific Serial Number
09890-0989

6008/1046

FIG. 4905

NEXT

<http://www.brandkey.com/bk-deliver/m-launch-corporate-create-5.html>

file:///F:/www/brandkey/bk_deliver/FMP/atruckejdhp.htm

5/7/2003

Brandkey Deliver Subsystem



Control Panel for Generating Corporate Specific (C-S) Virtual Kiosks

Configure C-S Virtual Kiosks
 Create C-S Virtual Kiosks
 Modify C-S Virtual Kiosks
 Deploy C-S Virtual Kiosks
 Activate C-S Virtual Kiosks

Standard Demonstration Mode

CUSTOMIZE CORPORATE-SPECIFIC VIRTUAL KIOSK

Client Account: DISNEY
 |
 Client Account No: 7145001
 |
 User Name: John Smith

Customize your Corporate-Specific Virtual Kiosk by selecting the desired Customization Options. Click Preview to preview the appearance of the customized Corporate-Specific Virtual Kiosk. Click Confirm to confirm the changes. Click Cancel to cancel your changes.

Customization Options

Corporate Logo:

Geometric Layout: square

Surface Texture: Black

Surface Color: Black

Button Style Set: square

Button Color Set: Black

Virtual Kiosk



FIG. 4906

669/1046



670/1046

FIG. 4907

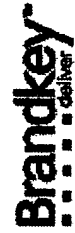

Control Panel for Generating Corporate-Specific (C-S) Virtual Kiosks

Configure C-S Virtual Kiosks Create C-S Virtual Kiosks Modify C-S Virtual Kiosks Deploy C-S Virtual Kiosks Activate C-S Virtual Kiosks

Standard Demonstration Mode

Common Operations for Corporate-Specific Virtual Kiosks

Client Account: DISNEY Client Account No: 7145001 User Name: John Smith

Congratulations, you have created the following Corporate-Specific Virtual Kiosks, you can now Modify or Deploy these Corporate-Specific Virtual Kiosks.

Corporate-Specific Virtual Kiosk Name	Corporate-Specific Virtual Kiosk Serial Number
Here will go the description of the product.	0900938-78383
Here will go the description of the product.	0900938-78383
Here will go the description of the product.	0900938-78383
Here will go the description of the product.	0900938-78383
Here will go the description of the product.	0900938-78383

◀ Back 1 2 3 4 5 Next ▶▶

671/1046

FIG. 4908



Control Panel for Generating Corporate-Specific (C-S) Virtual Kiosks

Configure C-S Virtual Kiosks | Create C-S Virtual Kiosks | Modify C-S Virtual Kiosks | Deploy C-S Virtual Kiosks | Activate C-S Virtual Kiosks

Standard Demonstration Mode

Select the Corporate-Specific Virtual Kiosk

Client Account: DISNEY | Client Account No: 7145001 | User Name: John Smith

Select the Corporate-Specific Virtual Kiosks you wish to modify by clicking on the Virtual Kiosk ID Number.

Virtual Kiosk ID Number	Store Location	Virtual Kiosk Name	Deployed	Active
<u>9909930-00939</u>	Here will go the store location	Virtual Kiosk name	✓	✓
<u>9909930-00939</u>	Here will go the store location	Virtual Kiosk name	✓	✓
<u>9909930-00939</u>	Here will go the store location	Virtual Kiosk name	✓	X
<u>9909930-00939</u>	Here will go the store location	Virtual Kiosk name	✓	✓
<u>9909930-00939</u>	Here will go the store location	Virtual Kiosk name	✓	X

◀◀ | 4 Back 1 2 3 4 5 Next ▶▶

672/1046

FIG. 49 P1

Control Panel for Generating Corporate Specific (C-S) Virtual Kiosks



Configure C-S Virtual Kiosks | Create C-S Virtual Kiosks | Modify C-S Virtual Kiosks | Deploy C-S Virtual Kiosks | Activate C-S Virtual Kiosks

Standard Demonstration Mode

Client Account: DISNEY | Client Account No: 7145001 | User Name: John Smith

Update the information for the selected Virtual Kiosk. Click Update to save your changes. Click Update Brands to update the list of Brand Entities associated with the selected Virtual Kiosk.

Virtual Kiosk Serial Number: 09009876-09

Virtual Kiosk Name:

- Display Mode:
- Tri-Mode Display comprising: Advertising Spot Display Mode, Promotional Spot Display Mode, and Brand Information Network Display Mode
 - Dual-Mode Display comprising: Advertising Spot Display Mode, and Brand Information Network Display Mode
 - Uni-Mode Display comprising: Brand Information Network Display Mode

Allow Consumer Installation: Yes No

Virtual Kiosk Status: Deployed-Activated



FIG. 49 P2

6/18/1046



Control Panel for Generating Corporate Specific (C-S) Virtual Kiosks

Configure C-S Virtual Kiosks | Create C-S Virtual Kiosks | Modify C-S Virtual Kiosks | Deploy C-S Virtual Kiosks | Activate C-S Virtual Kiosks

Standard Demonstration Mode

Modify Corporate Specific Virtual Kiosks

Client Account: DISNEY | Client Account No: 7145001 | User Name: John Smith

The Corporate-Specific Virtual Kiosk [Name] has been modified. Please review and confirm your modifications. If any information is not correct then click Edit to correct and update. Click Update Brands to update the list of Brand Entities associated with the selected Virtual Kiosk.

Virtual Kiosk Serial Number: 09009876-09

Virtual Kiosk Name: Virtual Kiosk Name

Virtual Kiosk Mode: Promo-Spot Display Mode

Allow Retailer Installation: Yes

Allow Industrialist Installation: No

Allow Consumer Installation: Yes

Virtual Kiosk Status: Deployed-Activated

674/1046

Edit | Update Brands | Confirm

FIG. 49P3



Control Panel for Generating Corporate-Specific (C-S) Virtual Kiosks

Configure C-S Virtual Kiosks | Create C-S Virtual Kiosks | Modify C-S Virtual Kiosks | Deploy C-S Virtual Kiosks | Activate C-S Virtual Kiosks

Standard Demonstration Mode

BRANDKEY ENTITIES

Client Account: DISNEY | Client Account No: 7145001 | User Name: John Smith

Please review the list of Brand Entities assigned to the Corporate-Specific Virtual Kiosks. To remove an associated Brand Entity from the Virtual Kiosk, simply uncheck the Active checkbox. To add new Brand Entities to the Virtual Kiosk list, click the Add Brands button. If you do not wish to add any more, click Finish to confirm the Virtual Kiosk Brand Entity list.

Brand Entity Name	Brand Entity Owner	Trade Mark (TM)	Product Descriptor (PD)	Selected
Here will go the Brand Entity	Here will go the Brand Entity Owner	Here will go the trade mark	Here will go the description of the product. Here will go the description of the product.	<input checked="" type="checkbox"/>
Here will go the Brand Entity	Here will go the Brand Entity Owner	Here will go the trade mark	Here will go the description of the product. Here will go the description of the product.	<input checked="" type="checkbox"/>
Here will go the Brand Entity	Here will go the Brand Entity Owner	Here will go the trade mark	Here will go the description of the product. Here will go the description of the product.	<input checked="" type="checkbox"/>
Here will go the Brand Entity	Here will go the Brand Entity Owner	Here will go the trade mark	Here will go the description of the product. Here will go the description of the product.	<input checked="" type="checkbox"/>
Here will go the Brand Entity	Here will go the Brand Entity Owner	Here will go the trade mark	Here will go the description of the product. Here will go the description of the product.	<input checked="" type="checkbox"/>

44 | Back 1 2 3 4 5 Next | >>

Product Descr. Finish

FIG. 4984

675/4046



Control Panel for Generating Corporate Specific (C-S) Virtual Kiosks

Configure C-S Virtual Kiosks | Create C-S Virtual Kiosks | Modify C-S Virtual Kiosks | Deploy C-S Virtual Kiosks | Activate C-S Virtual Kiosks

Standard Demonstration Mode

Search for Brand Entity

Client Account: DISNEY | Client Account No: 7145001 | User Name: John Smith

Search for the Brand Entities to add to the Corporate-Specific Virtual Kiosks. You may search by the Trade Mark, Product Descriptor or Brand Entity Name. Enter the search criteria in the textbox, select the parameters from the dropdown list and click the Search button to initiate the Brand Entity search.

Search for: [] By: TM [v]

676/1046

SEARCH

FIG. 49P5



Control Panel for Generating Corporate Specific (C-S) Virtual Kiosks

Configure C-S Virtual Kiosks | Create C-S Virtual Kiosks | Modify C-S Virtual Kiosks | Deploy C-S Virtual Kiosks | Activate C-S Virtual Kiosks

Standard Demonstration Mode

Sub-System

Client Account: DISNEY | Client Account No: 7145001 | User Name: John Smith

Select the Brand Entities to add to the Corporate-Specific Virtual Kiosks.

Brand Entity Name	Brand Entity Owner	Trade Mark (TM)	Product Descriptor (PD)	Add to Kiosk
Here will go the Brand Entity	Here will go the Brand Entity Owner	Here will go the trade mark	Here will go the description of the product. Here will go the description of the product.	<input type="checkbox"/>
Here will go the Brand Entity	Here will go the Brand Entity Owner	Here will go the trade mark	Here will go the description of the product. Here will go the description of the product.	<input type="checkbox"/>
Here will go the Brand Entity	Here will go the Brand Entity Owner	Here will go the trade mark	Here will go the description of the product. Here will go the description of the product.	<input type="checkbox"/>
Here will go the Brand Entity	Here will go the Brand Entity Owner	Here will go the trade mark	Here will go the description of the product. Here will go the description of the product.	<input type="checkbox"/>
Here will go the Brand Entity	Here will go the Brand Entity Owner	Here will go the trade mark	Here will go the description of the product. Here will go the description of the product.	<input type="checkbox"/>

Back 1 2 3 4 5 Next

677/1046

Next

FIG. 49 P6



Control Panel for Generating Corporate Specific (C-S) Virtual Kiosks

Configure C-S Virtual Kiosks | Create C-S Virtual Kiosks | Modify C-S Virtual Kiosks | Deploy C-S Virtual Kiosks | Activate C-S Virtual Kiosks

Standard Demonstration Mode

Client Account: DISNEY | Client Account No: 7145001 | User Name: John Smith

Corporate-Specific Virtual Kiosk has been modified. Please review and confirm the information below. If any information is not correct then click Edit to correct and update.

Name: Name goes here
ID: 0944930-9388399
Mode: Ad-Spot Display Mode

Table with 4 columns: Brand Entity Name, Brand Entity Owner, Trade Mark (TM), Product Descriptor (PD). Each row contains placeholder text: 'Here will go the Brand Entity Owner', 'Here will go the trade mark', and 'Here will go the description of the product.'

Navigation buttons: Back, 1, 2, 3, 4, 5, Next

Edit, Confirm buttons

Handwritten text: FIG. 49P7

Handwritten text: 670/1046



Control Panel for Generating Corporate Specific (C-S) Virtual Kiosks

Configure C-S Virtual Kiosks | Create C-S Virtual Kiosks | Modify C-S Virtual Kiosks | Deploy C-S Virtual Kiosks | Activate C-S Virtual Kiosks

Standard Demonstration Mode

Select Environment

Client Account: DISNEY | Client Account No: 7145001 | User Name: John Smith

Corporate-Specific Virtual Kiosk can be Deployed to Launch from one of four different Environments:

- An HTML-Encoded Brandkey(TM) Button for launching the Corporate-Specific Virtual Kiosk from any web page once the Brandkey(TM) Button and its accompanying Virtual Kiosk Tag have been installed in the page.
- An HTML-Encoded Document for launching the Corporate-Specific Virtual Kiosk from a Word or PDF Document once the Document containing its Virtual Kiosk Tag have been downloaded.
- An HTML-Encoded Image for launching the Corporate-Specific Virtual Kiosk from any web page once the Image and its accompanying Virtual Kiosk Tag have been installed in the page.
- An HTML-Encoded Desktop Icon for launching the Corporate-Specific Virtual Kiosk from any Computer Desktop once the Desktop Icon containing its Virtual Kiosk Tag has been installed on the Computer Desktop.

679/1046

Select the Environment from which the selected Corporate-Specific Virtual Kiosks will be launched:

- HTML-Encoded Brandkey (TM) Button
- HTML-Encoded Document
- HTML-Encoded Image
- HTML-Encoded Desktop Icon



FIG. 49Q1



Control Panel for Generating Corporate Kiosks (C-S) Virtual Kiosks

Configure C-S Virtual Kiosks | Create C-S Virtual Kiosks | Modify C-S Virtual Kiosks | Deploy C-S Virtual Kiosks | Activate C-S Virtual Kiosks

Standard Demonstration Mode

Select Corporate-Specific Virtual Kiosk(s)

Client Account: DISNEY | Client Account No: 7145001 | User Name: John Smith

Select the Corporate-Specific Virtual Kiosk(s) you wish to deploy.

Virtual Kiosk ID	Corporate-Specific Virtual Kiosk Name	Deploy
9909930-00939	Here will go the description of the retailer.	<input type="radio"/>
9909930-00939	Here will go the description of the retailer.	<input type="radio"/>
9909930-00939	Here will go the description of the retailer.	<input type="radio"/>
9909930-00939	Here will go the description of the retailer.	<input type="radio"/>
9909930-00939	Here will go the description of the retailer.	<input type="radio"/>

680/1046

44 | Back 1 2 3 4 5 Next >>

Back Next

FIG. 49 Q2



Control Panel for Generating Corporate Specific (C-S) Virtual Kiosks

Configure C-S Virtual Kiosks | Create C-S Virtual Kiosks | Modify C-S Virtual Kiosks | Deploy C-S Virtual Kiosks | Activate C-S Virtual Kiosks

Standard Demonstration Mode

Select Corporate Specific Virtual Kiosks to Deploy

Client Account: DISNEY | Client Account No: 7145001 | User Name: John Smith

Select the languages in which you wish to deploy the configured Virtual Kiosks.

Language	Selected	Language	Selected
English	<input type="checkbox"/>	Austrian	<input checked="" type="checkbox"/>
Spanish	<input checked="" type="checkbox"/>	Brazilian	<input checked="" type="checkbox"/>
French	<input checked="" type="checkbox"/>	Canadian French	<input checked="" type="checkbox"/>
German	<input checked="" type="checkbox"/>	Catalan	<input checked="" type="checkbox"/>
Japanese	<input checked="" type="checkbox"/>	Finnish	<input checked="" type="checkbox"/>
Dutch	<input checked="" type="checkbox"/>	Norwegian	<input checked="" type="checkbox"/>
Italian	<input checked="" type="checkbox"/>	Portuguese	<input checked="" type="checkbox"/>
Chinese	<input checked="" type="checkbox"/>	Swedish	<input checked="" type="checkbox"/>
Danish	<input checked="" type="checkbox"/>		

6801/1046



FIG. 4983A



Control Panel for Generating Corporate Specific (C-S) Virtual Kiosks

Configure C-S Virtual Kiosks | Create C-S Virtual Kiosks | Modify C-S Virtual Kiosks | Deploy C-S Virtual Kiosks | Activate C-S Virtual Kiosks

Standard Demonstration Mode

Client Account: DISNEY | Client Account No: 7145001 | User Name: John Smith

Select the image to upload that you wish to use as the base image for the HTML-Encoded image you wish to create.

Base Image:

Select the image to upload that you wish to use as the secondary image to place on top of the base image for the HTML-Encoded image you wish to create.

Secondary Image:

602/1046



FIG. 49Q3B



Control Panel for Generating Corporate Specific (C-S) Virtual Kiosks

Configure C-S Virtual Kiosks | Create C-S Virtual Kiosks | Modify C-S Virtual Kiosks | Deploy C-S Virtual Kiosks | Activate C-S Virtual Kiosks

Standard Demonstration Mode

Client Account: DISNEY | Client Account No: 7145001 | User Name: John Smith

Use the window below to format your new image which shall be used in the HTML-Encoded Image you wish to create. You may resize both the images if you wish. The Secondary Image shall always appear on top of the Base Image.

603/1046

STEP 2: CUSTOMIZE Beefy-T Shirt

Fig. 49 & 3c



604/1046

FIG. 49Q3D



Control Panel for Generating Corporate-Specific (C-S) Virtual Kiosks

Configure C-S Virtual Kiosks | Create C-S Virtual Kiosks | Modify C-S Virtual Kiosks | Deploy C-S Virtual Kiosks | Activate C-S Virtual Kiosks

Standard Demonstration Mode

Client Account: DISNEY | Client Account No: 7145001 | User Name: John Smith

The image you created is shown below. Please specify the area over which the consumer will click to launch the Corporate-Specific Virtual Kiosk.

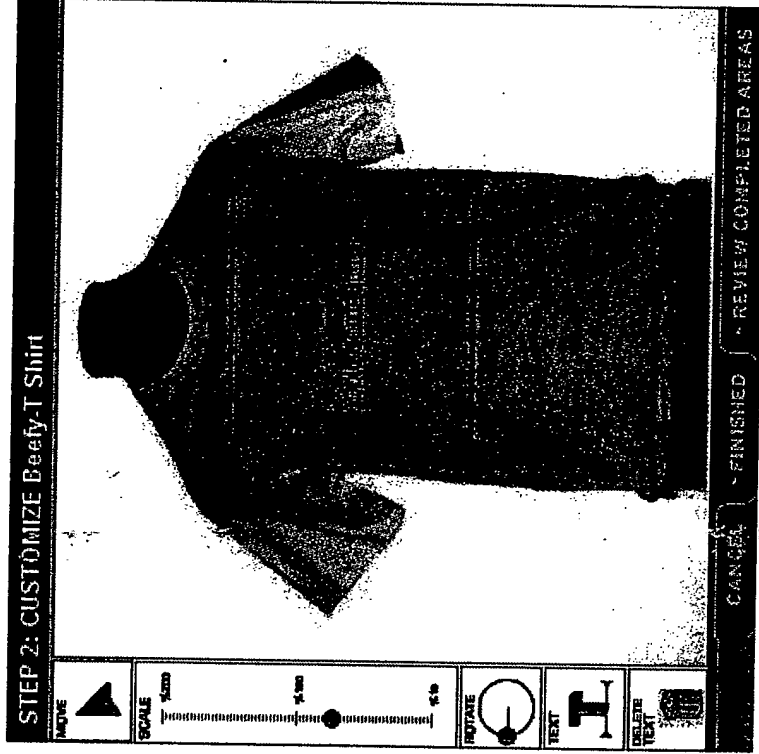

605/1046

FIG. 49Q3E



686/1046

6/17/2003

FIG. 49Q3F



Control Panel for Generating Corporate-Specific (C-S) Virtual Kiosks

Configure C-S Virtual Kiosks | Create C-S Virtual Kiosks | Modify C-S Virtual Kiosks | Deploy C-S Virtual Kiosks | Activate C-S Virtual Kiosks

Standard Demonstration Mode

Select Corporate-Specific Virtual Kiosks

Client Account: DISNEY | Client Account No: 7145001 | User Name: John Smith

Select the Corporate-Specific Virtual Kiosk(s) you wish to deploy.

Virtual Kiosk ID	Corporate-Specific Virtual Kiosk Name	Deploy
9909930-00939	Here will go the description of the retailer.	<input type="radio"/>
9909930-00939	Here will go the description of the retailer.	<input type="radio"/>
9909930-00939	Here will go the description of the retailer.	<input type="radio"/>
9909930-00939	Here will go the description of the retailer.	<input type="radio"/>
9909930-00939	Here will go the description of the retailer.	<input type="radio"/>

Back 1 2 3 4 5 Next

007/1046

Back Next

FIG. 4903G



Control Panel for Generating Corporate Speeches (C-S) Virtual Kiosks

Configure C-S Virtual Kiosks | Create C-S Virtual Kiosks | Modify C-S Virtual Kiosks | Deploy C-S Virtual Kiosks | Activate C-S Virtual Kiosks

Standard Demonstration Mode

Select Corporate Speeches to Deploy

Client Account: DISNEY | Client Account No: 7145001 | User Name: John Smith

Select the languages in which you wish to deploy the configured Virtual Kiosks.

Language	Selected	Language	Selected
English	<input type="checkbox"/>	Austrian	<input checked="" type="checkbox"/>
Spanish	<input checked="" type="checkbox"/>	Brazilian	<input checked="" type="checkbox"/>
French	<input checked="" type="checkbox"/>	Canadian French	<input checked="" type="checkbox"/>
German	<input checked="" type="checkbox"/>	Catalan	<input checked="" type="checkbox"/>
Japanese	<input checked="" type="checkbox"/>	Finnish	<input checked="" type="checkbox"/>
Dutch	<input checked="" type="checkbox"/>	Norwegian	<input checked="" type="checkbox"/>
Italian	<input checked="" type="checkbox"/>	Portuguese	<input checked="" type="checkbox"/>
Chinese	<input checked="" type="checkbox"/>	Swedish	<input checked="" type="checkbox"/>
Danish	<input checked="" type="checkbox"/>		

698/1046



FIG. 498 3H



Control Panel for Generating Corporate Specific (C-S) Virtual Kiosks

Configure C-S Virtual Kiosks | Create C-S Virtual Kiosks | Modify C-S Virtual Kiosks | Deploy C-S Virtual Kiosks | Activate C-S Virtual Kiosks

Standard Demonstration Mode

Client Account: DISNEY

Client Account No: 7145001

User Name: John Smith

Create or import the document into which you wish to embed the Corporate-Specific Virtual Kiosk tag. Click the Import button to load an existing document. The document must be in World format to load correctly.

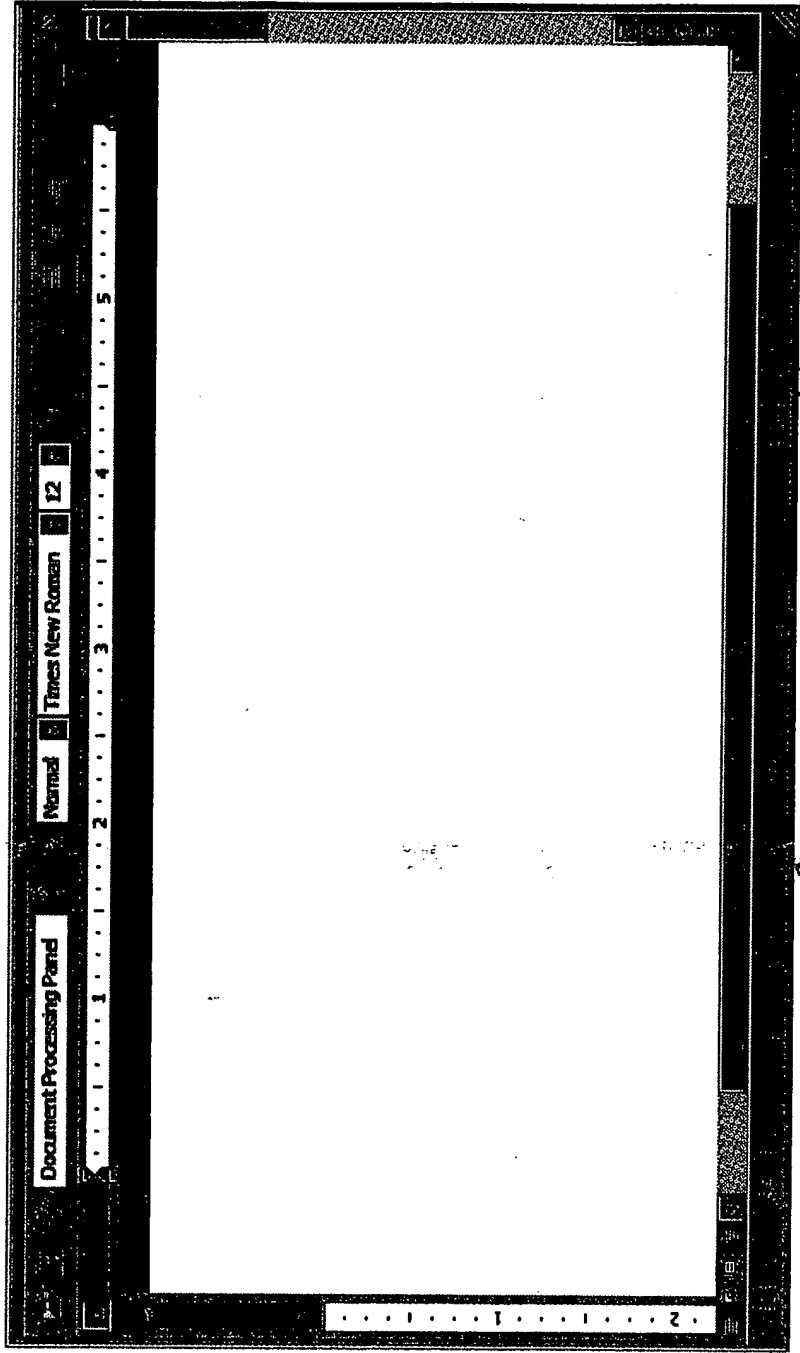

609/1046

FIG. 4903I

690/1046

6/17/2003

FIG. 49Q3J



Control Panel for Generating Corporate Specific (C-S) Virtual Kiosks

Configure C-S Virtual Kiosks | Create C-S Virtual Kiosks | Modify C-S Virtual Kiosks | Deploy C-S Virtual Kiosks | Activate C-S Virtual Kiosks

Standard Demonstration Mode

Selected HTML Embedded Document Format

Client Account: DISNEY | Client Account No: 7145001 | User Name: John Smith

The HTML-Embedded document has been saved. Please select the format of the HTML-Embedded document you wish to deploy to the Brandkey Systems Web Server.

- Microsoft Word Document format
- Adobe PDF Document format

691/1046



FIG. 49 Q3K



Control Panel for Generating Corporate Specific (C-S) Virtual Kiosks

Configure C-S Virtual Kiosks | Create C-S Virtual Kiosks | Modify C-S Virtual Kiosks | Deploy C-S Virtual Kiosks | Activate C-S Virtual Kiosks

Standard Demonstration Mode

Client Account: DISNEY | Client Account No: 7145001 | User Name: John Smith

Select the Corporate-Specific Virtual Kiosk(s) you wish to deploy.

Virtual Kiosk ID	Corporate-Specific Virtual Kiosk Name	Deploy
9909930-00939	Here will go the description of the retailer.	<input type="radio"/>
9909930-00939	Here will go the description of the retailer.	<input type="radio"/>
9909930-00939	Here will go the description of the retailer.	<input type="radio"/>
9909930-00939	Here will go the description of the retailer.	<input type="radio"/>
9909930-00939	Here will go the description of the retailer.	<input type="radio"/>

4 | < Back 1 2 3 4 5 Next > | >>

Back Next

092/1046

FIG. 4903L



Control Panel for Generating Corporate Specific (C-S) Virtual Kiosks

Configure C-S Virtual Kiosks | Create C-S Virtual Kiosks | Modify C-S Virtual Kiosks | Deploy C-S Virtual Kiosks | Activate C-S Virtual Kiosks

Standard Demonstration Mode

Select Corporate Specific Virtual Kiosk Language

Client Account: DISNEY | Client Account No: 7145001 | User Name: John Smith

Select the languages in which you wish to deploy the configured Virtual Kiosks.

Language	Selected	Language	Selected
English	<input type="checkbox"/>	Austrian	<input checked="" type="checkbox"/>
Spanish	<input checked="" type="checkbox"/>	Brazilian	<input checked="" type="checkbox"/>
French	<input checked="" type="checkbox"/>	Canadian French	<input checked="" type="checkbox"/>
German	<input checked="" type="checkbox"/>	Catalan	<input checked="" type="checkbox"/>
Japanese	<input checked="" type="checkbox"/>	Finnish	<input checked="" type="checkbox"/>
Dutch	<input checked="" type="checkbox"/>	Nonwegian	<input checked="" type="checkbox"/>
Italian	<input checked="" type="checkbox"/>	Portuguese	<input checked="" type="checkbox"/>
Chinese	<input checked="" type="checkbox"/>	Swedish	<input checked="" type="checkbox"/>
Danish	<input checked="" type="checkbox"/>		

693/1046



FIG. 49 Q 3M



Control Panel for Generating Corporate Brandable (C-S) Virtual Kiosks

Configure C-S Virtual Kiosks | Create C-S Virtual Kiosks | Modify C-S Virtual Kiosks | Deploy C-S Virtual Kiosks | Activate C-S Virtual Kiosks

Standard Demonstration Mode

Client Account: DISNEY | Client Account No: 7145001 | User Name: John Smith

Please Upload the image you wish to use as the icon for the HTML-Encoded icon you wish to deploy.

Icon Image:

694/1046



FIG. 49Q3N



Control Panel for Generating Corporate Specific (C-S) Virtual Kiosks

Configure C-S Virtual Kiosks | Create C-S Virtual Kiosks | Modify C-S Virtual Kiosks | Deploy C-S Virtual Kiosks | Activate C-S Virtual Kiosks

Standard Demonstration Mode

Confirm Deployment of Corporate Specific Virtual Kiosks

Client Account: DISNEY | Client Account No: 7145001 | User Name: John Smith

The selected Corporate-Specific Virtual Kiosks have now been Deployed in the selected Launch Environment. To prepare the Deployed Corporate-Specific Virtual Kiosks for Installation, you must first Activate them.

096/1046

FIG. 4905



Control Panel for Generating Corporate Kiosks (C-S) Virtual Kiosks

Configure C-S Virtual Kiosks | Create C-S Virtual Kiosks | Modify C-S Virtual Kiosks | Deploy C-S Virtual Kiosks | Activate C-S Virtual Kiosks

Standard Demonstration Mode

Control Panel for Generating Corporate-Specific Virtual Kiosks

Client Account: DISNEY | Client Account No: 7145001 | User Name: John Smith

The Virtual Kiosks below have been deployed. You can activate any of the Virtual Kiosk by checking the Active field for that Virtual Kiosk. To deactivate any Virtual Kiosk simply uncheck the Active field for the Virtual Kiosk. Click Update to save the changes.

Virtual Kiosk ID	Virtual Kiosk Name	Active
Here will go the min	Here will go the product name	<input checked="" type="checkbox"/>
Here will go the min	Here will go the product name	<input type="checkbox"/>
Here will go the min	Here will go the product name	<input type="checkbox"/>
Here will go the min	Here will go the product name	<input type="checkbox"/>
Here will go the min	Here will go the product name	<input type="checkbox"/>

44 | Back 1 2 3 4 5 Next |>>

Activate

FIG. 49R1

697/1046

698/1046



Virtual Kiosk Installation Suite - Standard Demonstration Mode

- ▶ Launch Control Panel for Installing Product-Specific Virtual Kiosks
- ▶ Launch Control Panel for Installing Service-Specific Virtual Kiosks
- ▶ Launch Control Panel for Installing Vendor-Specific Virtual Kiosks
- ▶ Launch Control Panel for Installing Retailer-Specific Virtual Kiosks
- ▶ Launch Control Panel for Installing Provider-Specific Virtual Kiosks
- ▶ Launch Control Panel for Installing Retailer-Specific Virtual Kiosks
- ▶ Launch Control Panel for Installing Industry-Specific Virtual Kiosks
- ▶ Launch Control Panel for Installing Corporate-Specific Virtual Kiosks

Client Account: DISNEY | Client Account No: 7145001 | User Name: John Smith

Text: R.148

FIG. 50A



Install Product: Specific Virtual Kicks

Control Panel for Installing Product Specific Virtual Kicks

Standard Demonstration Mode

Control Panel for Installing Product Specific Virtual Kicks

Client Account: DISNEY

Client Account No: 7145001

User Name: John Smith

Text: R.135

699/1046

FIG. 50B1



Control Panel for Installing Product-Specific Virtual Kiosks

Install Product-Specific Virtual Kiosks

Standard Demonstration Mode

Client Account: DISNEY | Client Account No: 7145001 | User Name: John Smith

The following Product-Specific Virtual Kiosks are available for installation. Select the Product-Specific Virtual Kiosks you wish to install by checking the install checkbox. -- for everyone

If there are Product-Specific Virtual Kiosks available for more than one Vendor, then the Product-Specific Virtual Kiosks shall be sorted by Vendor name. Click "A" to view Product-Specific Virtual Kiosks from Vendors beginning with the letter "A", etc. -- for only consumers

Click Next to install the selected Product-Specific Virtual Kiosks. -- for everyone

Click Search to search for the Product-Specific Virtual Kiosks associated with a particular Vendor. -- for only consumers. Below the alphabet bar is also only for consumers. Below the Search button also shall only be visible for consumers.

A B C D E F G H I J K L M N O P Q R S T U V W X Y Z I

1 1 1 2 1 3 1 4 1 5 1 6 1 7 1 8 1 9 1 0 1

Vendor Name	P-S Virtual Kiosk Serial Number	P-S Virtual Kiosk Name	Launch Environment	Installation Language	Currently Installed	Install
Vendor Name 1	0900989098-88	Virtual Kiosk Name 1	Deployment Environment 1	Installation language	Currently Installed	<input type="checkbox"/>
Vendor Name 2	0900989098-88	Virtual Kiosk Name 2	Deployment Environment 2	Installation language	Currently Installed	<input type="checkbox"/>
Vendor Name 3	0900989098-88	Virtual Kiosk Name 3	Deployment Environment 3	Installation language	Currently Installed	<input type="checkbox"/>
Vendor Name 4	0900989098-88	Virtual Kiosk Name 4	Deployment Environment 4	Installation language	Currently Installed	<input type="checkbox"/>
Vendor Name 5	0900989098-88	Virtual Kiosk Name 5	Deployment Environment 5	Installation language	Currently Installed	<input type="checkbox"/>

◀ Back 1 2 3 4 5 Next ▶▶

Search Next

FIG. 50 C1

700/1046



Control Panel for Installing Product-Specific Virtual Kiosks

Install Product-Specific Virtual Kiosks

Download Virtual Kiosk Tray

Standard Demonstration Mode

Client Account: DISNEY | Client Account No: 7145001 | User Name: John Smith

Search for the Vendor who has Deployed Product-Specific Virtual Kiosks which you wish to Install. You can search by Vendor Name or Manufacturer Identification Number (MIN). Click Next to Initiate the Vendor Search.

Search for:

Search by: Vendor Name

Back Next

FIG. 5002

fol 1046



Control Panel for Installing Product-Specific Virtual Kiosks

Install Product-Specific Virtual Kiosks

Download Virtual Kiosk

Standard Demonstration Mode

Client Account: DISNEY | Client Account No: 7145001 | User Name: John Smith

The following Vendors matched your Search Criteria and have Deployed Product-Specific Virtual Kiosks that are available for Installation. Click on the Vendor Name to View its Deployed Product-Specific Virtual Kiosks.

Vendor Name	Manufacturer Identification Number (MIN)	No. of P-S Virtual Kiosks
<u>Vendor Name 1</u>	MIN 1	Virtual Kiosk No 1
<u>Vendor Name 2</u>	MIN 2	Virtual Kiosk No 2
<u>Vendor Name 3</u>	MIN 3	Virtual Kiosk No 3
<u>Vendor Name 4</u>	MIN 4	Virtual Kiosk No 4
<u>Vendor Name 5</u>	MIN 5	Virtual Kiosk No 5

7021 1046

FIG. 50C3

https://www.brandkeysystems.com/bk_deliver/m_install_product-3.html

file://www.brandkeybk_deliver/TMP73f8esc8g.htm

Back



Control Panel for installing Product Specific Virtual Kiosks

Install Product Specific Virtual Kiosks

System Installation Location Information

Standard Demonstration Mode

Client Account: DISNEY | Client Account No: 7145001 | User Name: John Smith

The following Information is required before you can Download the Installation Files for the selected Product-Specific Virtual Kiosks.

User Name:

Installation Domain:

(e.g: www.virtualkiosksite.com)

Physical Location:

City:

State: -- Select One --

Zip/Postal Code:

Country:

United States

Purpose of Installation:

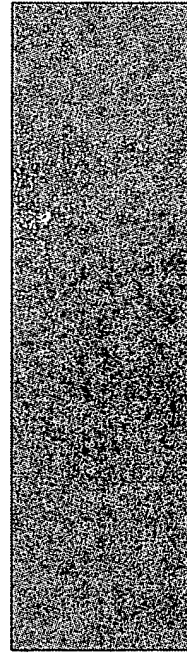

704/1046

Back Next

FIG. 50C5



Control Panel for Installing Product Specific Virtual Kiosks

Install Product-Specific Virtual Kiosks

Standard Demonstration Mode

~~Downloaded Virtual Kiosk Tags~~

Client Account: DISNEY | Client Account No: 7145001 | User Name: John Smith

The Installation Files have been prepared for the selected Product-Specific Virtual Kiosks. These Product-Specific Virtual Kiosks are Launchable from the following Environments.

Launch Environment	Selected	Downloaded Tags
HTML-Encoded Brandkey(TM) Button	<input checked="" type="checkbox"/>	Downloaded Tags
HTML-Encoded Document	<input checked="" type="checkbox"/>	Downloaded Tags
HTML-Encoded Image	<input checked="" type="checkbox"/>	Downloaded Tags
HTML-Encoded Desktop Icon	<input checked="" type="checkbox"/>	Downloaded Tags

705/1046

FIG. 50C6

706/1046

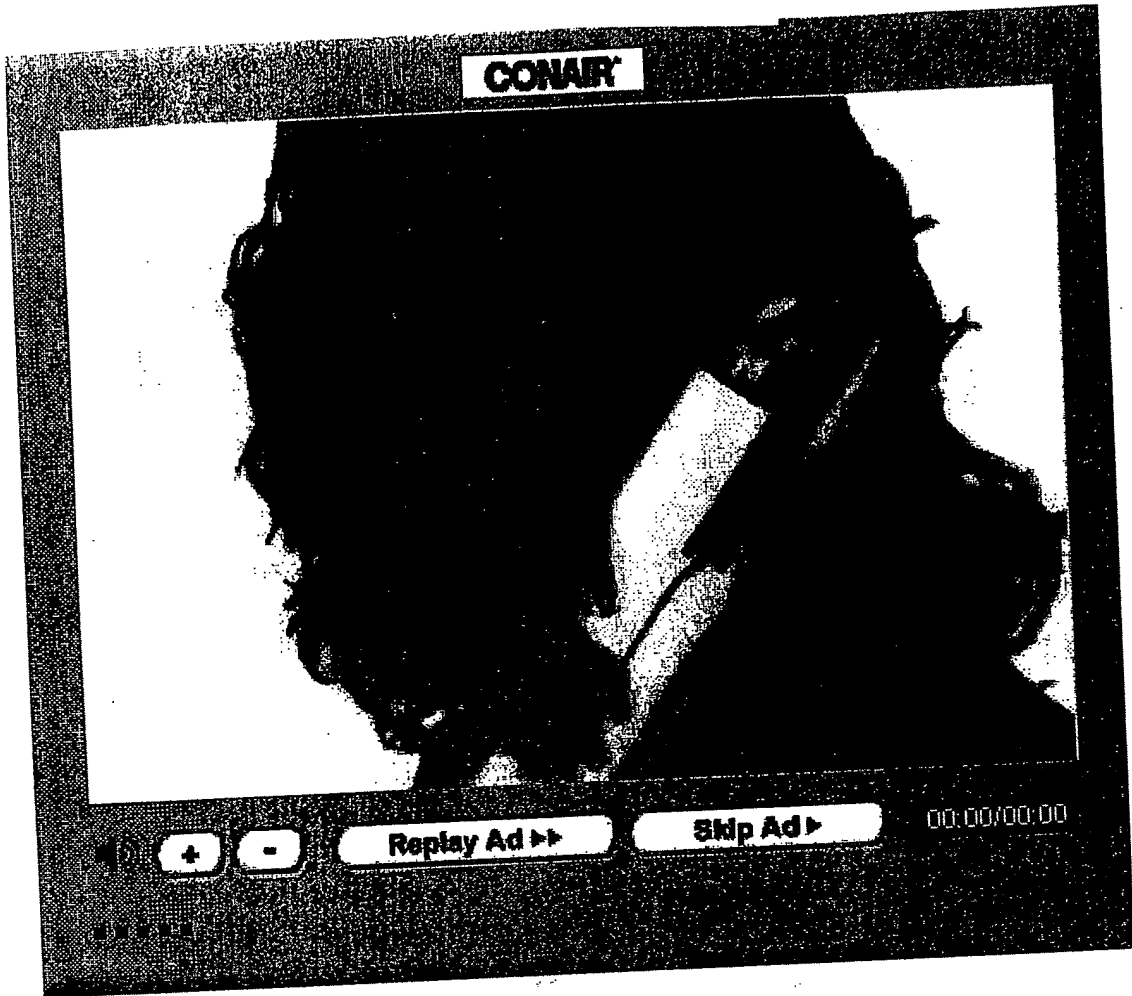

FIG. 50 D1

PS-VIK

707/1046



The image shows a promotional video player interface for CONAIR. At the top, there is a "CONAIR" logo in a white box. Below it, three circular icons represent different product categories: a hairbrush, a hair curler, and a hair dryer. The main text in the center reads "All Products 20% OFF". To the right, there is a partial view of a woman's face. Below the main text, there is a small image of a gift box and the text "Buy a Special Gift For Mom". At the bottom, there is a control bar with a play button, volume controls (+ and -), "Replay Promo" and "Skip Promo" buttons, and a timer showing "00:00/00:00". Below the control bar, there is a text overlay: "Mother's Day Sale... All Products 20% OFF May 2-12".

FIG. 50D2

710/1046

CONAIR

CONAIR

Contest: What Conair did for me!

Send us photos of your hairstyle before and after you used a Conair hair care appliance and you could win a prize!



Send in your picture and win a gift!

+ - **Replay Promo** ▶▶ **Skip Promo** ▶▶ 00:00/00:00

▶ Mother's Day Sale ... All Products 20% OFF May 2-12





FIG. 50 D3

709/1046

CONAIR

CONAIR®

+ **-** **Replay Ad >>** **Skip Ad >** 00:00/00:00

▶ PRE-PURCHASE LINKS	▶ POST-PURCHASE LINKS
	
	

◀◀ Back 1 2 3 Next ▶▶▶ ◀◀ Back 1 2 3 Next ▶▶▶

▶ Conair Ion Shine Hair dryer **Results** **Search**

FIG. 5004

710/1046



CONAIR

[PRODUCTS](#)
[ABOUT US](#)
[CONTACT US](#)

Ion Shine
Model 1401



Ion Shine Hair Dryer
 Currently in stock.
 Typically ships within 24 hours.

Item# CON1401 **20% OFF**
Price: \$ 29.99
Promo price: \$ 23.99

[Add to Cart](#)
[Email a friend](#)

Features:

- 1875 Watts of Drying Power
- Full Size
- Ionic Device
- Quiet Tone Motor
- 2 Heat/Speed Settings
- Cool Shot Button

Replay Ad >>

Skip Ad >

00:00/00:00

▶ PRE-PURCHASE LINKS

[View Product Page](#)

[View Product Page](#)

<< | < Back < 2 > Next | >>

▶ POST-PURCHASE LINKS

[View Product Page](#)

[View Product Page](#)

<< | < Back < 2 > Next | >>

▶ Shop Online

★★★★★

RATING 5

[Vote](#)
[Search](#)

FIG. 50D5



Install Service-Specific Virtual Kiosks

Control Panel for Installing Service-Specific Virtual Kiosks

Standard Demonstration Mode

Client Account: DISNEY

Client Account No: 7145001

User Name: John Smith

Text: R.135

711/1046

FIG. 50E



Install Service-Specific Virtual Kiosks

Control Panel for Installing Service-Specific Virtual Kiosks

Standard Demonstration Mode

Client Account: DISNEY

Client Account No: 7145001

User Name: John Smith

The following Service-Specific Virtual Kiosks are available for installation. Select the Service-Specific Virtual Kiosks you wish to install by checking the install checkbox. -- for everyone

If there are Service-Specific Virtual Kiosks available for more than one Service Provider, then the Service-Specific Virtual Kiosks shall be sorted by Service Provider name. Click "A" to view Service-Specific Virtual Kiosks from Service Providers beginning with the letter "A", etc. -- for only consumers

Click Next to install the selected Service-Specific Virtual Kiosks. -- for everyone

Click Search to search for the Service-Specific Virtual Kiosks associated with a particular Service Provider. -- for only consumers. Below the alphabet bar is also only for consumers. Below the Search button also shall only be visible for consumers.

A B C D E F G H I J K L M N O P Q R S T U V W X Y Z I

1 1 1 2 3 4 5 6 7 8 9 10 11

Service Provider Name	S-S Virtual Kiosk Number	S-S Virtual Kiosk Serial	S-S Virtual Kiosk Name	Launch Environment	Installation Language	Currently Installed	Install
Service Provider Name 1	0900989098-88		Virtual Kiosk Name 1	Deployment Environment 1	Installation language	Currently Installed	<input type="checkbox"/>
Service Provider Name 2	0900989098-88		Virtual Kiosk Name 2	Deployment Environment 2	Installation language	Currently Installed	<input type="checkbox"/>
Service Provider Name 3	0900989098-88		Virtual Kiosk Name 3	Deployment Environment 3	Installation language	Currently Installed	<input type="checkbox"/>
Service Provider Name 4	0900989098-88		Virtual Kiosk Name 4	Deployment Environment 4	Installation language	Currently Installed	<input type="checkbox"/>
Service Provider Name 5	0900989098-88		Virtual Kiosk Name 5	Deployment Environment 5	Installation language	Currently Installed	<input type="checkbox"/>

◀ Back 1 2 3 4 5 Next ▶▶

Search Next

FIG. 50 F1



Control Panel for Installing Service-Specific Virtual Kiosks

Install Service-Specific Virtual Kiosks
Download Virtual Kiosk

Standard Demonstration Mode

Search for Service Provider

Client Account: DISNEY | Client Account No: 7145001 | User Name: John Smith

Search for the Service Provider whose Service-Specific Virtual Kiosks you wish to install. Click Next to initiate the Service-Provider search.

Search for:

Search by: Service Provider Name

713/1046

FIG. 50F2



Control Panel for Installing Service Specific Virtual Kiosks

Install Service-Specific Virtual Kiosks

Virtual Kiosk No 1 Virtual Kiosk No 2 Virtual Kiosk No 3 Virtual Kiosk No 4 Virtual Kiosk No 5

Standard Demonstration Mode

Client Account: DISNEY

Client Account No: 7145001

User Name: John Smith

The following Service Provider matched your search criteria and have Service-Specific Virtual Kiosks available to install. Click on the Service Provider Name to view Service-Specific Virtual Kiosks for the selected Service Provider.

Service Provider Name	Service Provider Identification Number (SPIN)	No. of Virtual Kiosks
<u>Service Provider Name 1</u>	SPIN 1	Virtual Kiosk No 1
<u>Service Provider Name 1</u>	SPIN 1	Virtual Kiosk No 2
<u>Service Provider Name 1</u>	SPIN 1	Virtual Kiosk No 3
<u>Service Provider Name 1</u>	SPIN 1	Virtual Kiosk No 4
<u>Service Provider Name 1</u>	SPIN 1	Virtual Kiosk No 5

7/11/03

FIG. 50F3

http://www.brandkeysystems.com/bk_deliver/m-install-service-3.html



Control Panel for installing Service-Specific Virtual Kiosks

Install Service-Specific Virtual Kiosks
Download Virtual Kiosk Tag

Standard Demonstration Mode

Client Account: DISNEY | Client Account No: 7145001 | User Name: John Smith

The following information is required before you can download the installation files for the Service-Specific Virtual Kiosks. This information is used by Service Provider and their agents to better customize the Service-Specific Virtual Kiosks for your needs.

User Name:

Installation Domain: (e.g: www.virtualkiosklaunchsite.com)

Physical Location:

City:

State: -- Select One --

Zip/Postal Code:

Country: United States

Purpose of Installation:



FIG. 50 F5

716/1046



Control Panel for Installing Service-Specific Virtual Kiosks

Install Service-Specific Virtual Kiosks

Standard Demonstration Mode

Client Account: DISNEY

Client Account No: 7145001

User Name: John Smith

The setup files for the selected Service-Specific Virtual Kiosk(s) have been prepared. You have selected Service-Specific Virtual Kiosk(s) that are Launchable from the following environments.

Launch Environment Selected

HTML-Embedded Default Logo	<input checked="" type="checkbox"/>	
HTML-Embedded Document	<input checked="" type="checkbox"/>	
HTML-Encoded Image	<input checked="" type="checkbox"/>	
HTML-Encoded Desktop Icon	<input checked="" type="checkbox"/>	

717/1046

FIG. 50F6

718/1046



FIG. 50 G 1

TS-VK

119/1046

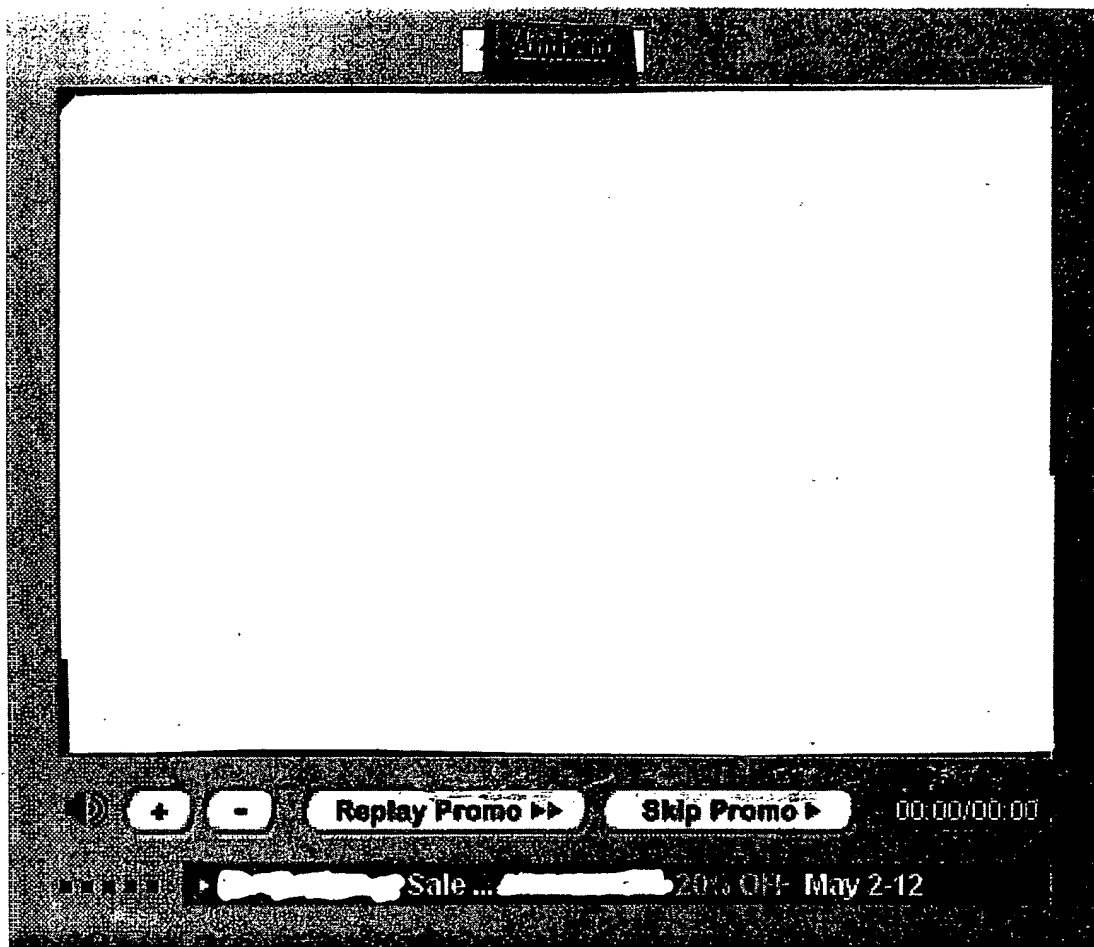

FIG. 50G2

720/1046

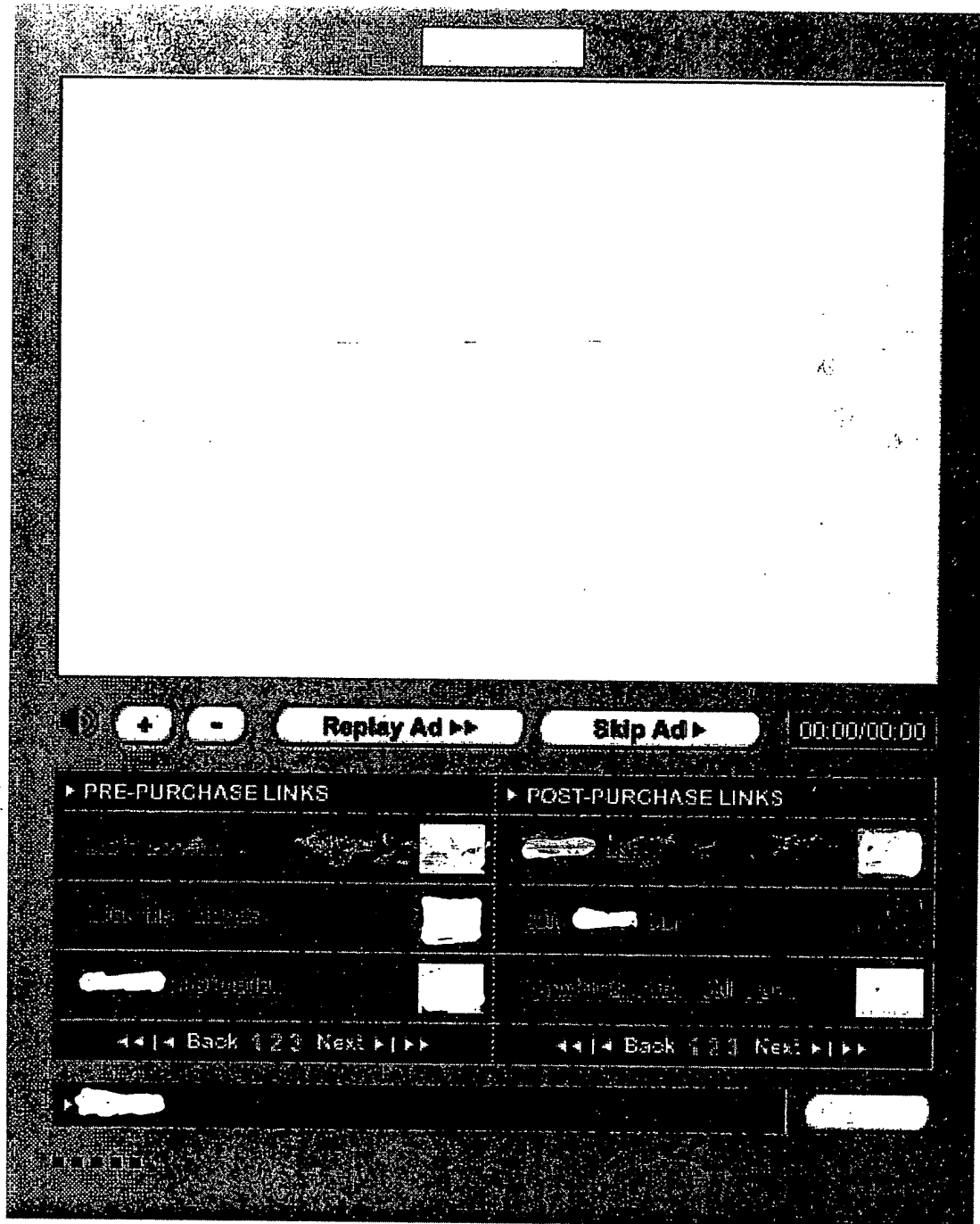

FIG 5093



Install Vendor - Specific Virtual Kiosks

Control Panel for Installing Vendor Specific Virtual Kiosks

Standard Demonstration Mode

Client Account: DISNEY

Client Account No: 7145001

User Name: John Smith

Text: R.135

7211046

FIG. 50H



Control Panel for installing Vendor Specific Virtual Kiosks

Install Vendor-Specific Virtual Kiosks

Search for information, Download Virtual Kiosk

Standard Demonstration Mode

Client Account: DISNEY | Client Account No: 7145001 | User Name: John Smith

The following Vendor-Specific Virtual Kiosks are available for installation. Select the Vendor-Specific Virtual Kiosks you wish to install by checking the install checkbox. -- for everyone

If there are Vendor-Specific Virtual Kiosks available for more than one Vendor, then the Vendor-Specific Virtual Kiosks shall be sorted by Vendor name. Click "A" to view Vendor-Specific Virtual Kiosks from Vendors beginning with the letter "A", etc. -- for only consumers

Click Next to install the selected Vendor-Specific Virtual Kiosks. -- for everyone

Click Search to search for the Vendor-Specific Virtual Kiosks associated with a particular Vendor. -- for only consumers. Below the alphabet bar is also only for consumers. Below the Search button also shall only be visible for consumers.

A B C D E F G H I J K L M N O P Q R S T U V W X Y Z I

1 1 2 1 3 1 4 1 5 1 6 1 7 1 8 1 9 1 0 1

722/1046

Vendor Name	V-S Virtual Kiosk Number	V-S Virtual Kiosk Serial	Virtual Kiosk Name	Launch Environment	Installation Language	Currently Installed	Install
Vendor Name 1	0900989098-88		Virtual Kiosk Name 1	Deployment Environment 1	Installation language	Currently Installed	<input type="checkbox"/>
Vendor Name 2	0900989098-88		Virtual Kiosk Name 2	Deployment Environment 2	Installation language	Currently Installed	<input type="checkbox"/>
Vendor Name 3	0900989098-88		Virtual Kiosk Name 3	Deployment Environment 3	Installation language	Currently Installed	<input type="checkbox"/>
Vendor Name 4	0900989098-88		Virtual Kiosk Name 4	Deployment Environment 4	Installation language	Currently Installed	<input type="checkbox"/>
Vendor Name 5	0900989098-88		Virtual Kiosk Name 5	Deployment Environment 5	Installation language	Currently Installed	<input type="checkbox"/>

4 4 | 4 Back 1 2 3 4 5 Next > | >>

FIG. 50II

Search Next



Install Vendor-Specific Virtual Kiosks

Search for Vendor-Specific Virtual Kiosks

Control Panel for Installing Vendor-Specific Virtual Kiosks

Standard Demonstration Mode

Search for Vendor

Client Account: DISNEY | Client Account No: 7145001 | User Name: John Smith

Search for the Vendor whose Vendor-Specific Virtual Kiosks you wish to install. Click Next to initiate the Vendor search.

Search for:

Search by: Vendor Name

723/1046



FIG 5012

Control Panel for installing Vendor-Specific Virtual Kiosks



Install Vendor-Specific Virtual Kiosks

Standard Demonstration Mode

Select Vendor

Client Account: DISNEY | Client Account No: 7145001 | User Name: John Smith

The following Vendors matched your search criteria and have Vendor-Specific Virtual Kiosks available to install. Click on the Vendor Name to view Vendor-Specific Virtual Kiosks for the selected Vendor.

Vendor Name	Vendor Identification Number (MIN)	No. of Virtual Kiosks
<u>Vendor Name 1</u>	MIN 1	Virtual Kiosk No 1
<u>Vendor Name 2</u>	MIN 2	Virtual Kiosk No 2
<u>Vendor Name 3</u>	MIN 3	Virtual Kiosk No 3
<u>Vendor Name 4</u>	MIN 4	Virtual Kiosk No 4
<u>Vendor Name 5</u>	MIN 5	Virtual Kiosk No 5

724/1046

FIG. 50I3

Back

http://www.brandkey.com/bk-deliver/m-install_vendor-3.htm
file://E:\www.brandkey\bk_deliver\TA\PP0\wz9gesfw2.htm



Install Vendor-Specific Virtual Kiosks

Setup Virtual Kiosks

Download Virtual Kiosk Files

Control Panel for Installing Vendor-Specific Virtual Kiosks

Standard Demonstration Mode

Client Account: DISNEY

Client Account No: 7145001

User Name: John Smith

The following information is required before you can download the installation files for the Vendor-Specific Virtual Kiosks. This information is used by Vendors and their agents to better customize the Vendor-Specific Virtual Kiosks for your needs.

User Name:

Installation Domain:

(e.g. www.virtualkiosklaunchsite.com)

Physical Location:

City:

State:

Zip/Postal Code:

Country:

Purpose of Installation:

120/1046



FIG. 5075



Install Vendor-Specific Virtual Kiosks

Control Panel for Installing Vendor-Specific Virtual Kiosks

Standard Demonstration Mode

Download Virtual Kiosk Log

Client Account: DISNEY

Client Account No: 7145001

User Name: John Smith

The setup files for the following Vendor-Specific Virtual Kiosk(s) have been prepared. You have selected Vendor-Specific Virtual Kiosk(s) that are Launchable from the following environments.

Launch Environment	Selected
HTML-Embedded Default Logo	<input checked="" type="checkbox"/>
HTML-Embedded Document	<input checked="" type="checkbox"/>
HTML-Encoded Image	<input checked="" type="checkbox"/>
HTML-Encoded Desktop Icon	<input checked="" type="checkbox"/>

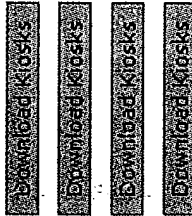

12271046

FIG. 50I6

720/1046



FIG. 5051

VS-VK

729/1046

CONAIR

CONAIR

All Products 20% OFF

Buy a Special Gift For Mom

+

-

Replay Promo ▶▶

Skip Promo ▶

00:00/00:00

• Mother's Day Sale ... All Products 20% OFF May 2-12

FIG. 50J2

735/1046

CONAIR

CONAIR

Contest: What Conair did for me!

Send us photos of your hairstyle before and after you used a Conair hair care appliance and you could win a prize!



Send in your picture and win a gift!

+ **-** **Replay Promo >>** **Skip Promo >** 00:00/00:00

• Mother's Day Sale ... All Products 20% OFF May 2-12

FIG. 50J3

731/1046

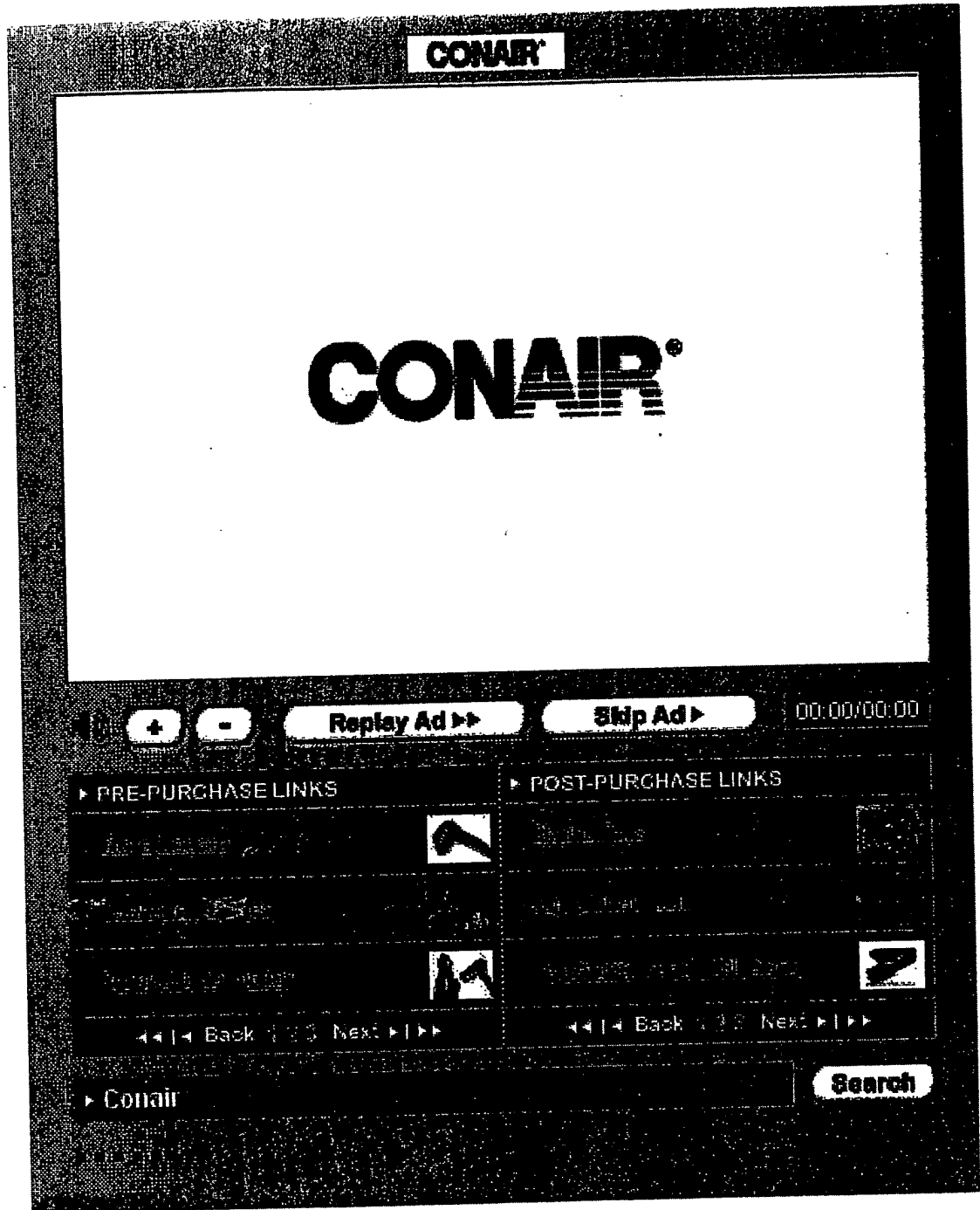



FIG. 50J4

732/1046



CONAIR

HOME

CONTACT US

ABOUT US

Jola Conair Club

Styling Tips

Customer Stories

Featured Contest

Featured Club

Customer Stories



My husband has been using his hot roller machine for over two years, since I got it for him for Father's Day a few years ago.

(When the first one "died", he was most upset, so I sent it back since it was still under warranty and received a new one free of charge. It is still going strong.

Thank you for your excellent customer service, and I recommend your products to all my family and friends. Keep up the good work.

Jean Sturgeon





Read Story

+
-

Replay Ad ▶▶

Skip Ad ▶▶

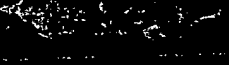
00:00/00:00

▶ PRE-PURCHASE LINKS	▶ POST-PURCHASE LINKS
<p>Hot Roller</p> 	<p>Styling Tip</p> 
<p>Customer Story</p> 	<p>Product Review</p> 
<p>Featured Contest</p> 	<p>Feedback</p> 

◀◀ Back 4 2 5 Next ▶▶▶▶

◀◀ Back 7 8 Next ▶▶▶▶

▶ Customer Stories

★★★★★

RATING

5

Vote

Search

FIG. 50 JS

733/1046



CONAIR

PRODUCTS MAKEUP HAIR STYLING

Special Ad

Join Conair® Club

Styling Tips

Customer Stories

Featured Contest

Featured Links

Customer Stories



My husband has been using his hot roller machine for over two years, since I got it for him for Father's Day a few years ago.

When the first one "died", he was most upset, so I sent it back since it was still under warranty and received a new one free of charge. It is still going strong.

Thank you for your excellent customer service, and I recommend your products to all my family and friends. Keep up the good work.

Joan Sturgeon

Read Story

+
-

Replay Ad ▶▶

Skip Ad ▶▶

00:00/00:00

▶ PRE-PURCHASE LINKS

Hot Roller Machine



Hot Roller Machine



Hot Roller Machine



◀◀ Back (2) Next ▶▶▶

▶ POST-PURCHASE LINKS

Hot Roller Machine



Hot Roller Machine



Hot Roller Machine



◀◀ Back (2) Next ▶▶▶

▶ Customer Stories

★★★★★

RATING

1

2

3

4

5

5

Vote

Search

FIG. 5056

734/1046

CONAIR

CONAIR

Home | My Account | Site Map

Features

- [Join Conair® Club](#)
- [Styling Tips](#)
- [Customer Stories](#)
- [Featured Contest](#)

Customer Stories



My husband has been using his hot roller machine for over two years, since I got it for him for Father's Day a few years ago.

When the first one "died", he was most upset, so I can't blame it since it was still under warranty and received a new one free of charge. It is still going strong.

Thank you for your excellent customer service, and I recommend your products to all my family and friends. Keep up the good work.

Jean Sturgeon

Real Story

▶ **PRODUCT SEARCH**

Search For:

By:

00:00:00.00

Replay Ad ▶▶ **Skip Ad ▶▶**

FIG. 5057

735/1046

CONAIR

LEADERS HOW TO USE LIFESTYLE

CONAIR

Join Conair Club

Styling Tips

Customer Stories

Featured Contest

Customer Stories



My husband has been using his hot leather machine for over two years, since I got it for him for Father's Day a few years ago.

When the first one "died", he was most upset, so I sent it back since it was still under warranty and received a new one free of charge. It is still going strong.

Thank you for your excellent customer service, and I recommend your products to all my family and friends. Keep up the good work.

Jean Surgeon

Real Story

+
-
Replay Ad >>
Skip Ad >
00:00:00.00

▶ PRODUCT SEARCH

Search For:

By:

FIG. 50J8

136/1046





[HOME](#)

[ABOUT US](#)

Join Conair® Club

Styling Tips

Customer Stories

Featured Contest

Customer Stories



My husband has been using his hot roller machine for over two years, since I got it for him for Father's Day a few years ago.

When the first one "died", he was most upset, so I sent it back since it was still under warranty and received a new one free of charge. It is still going strong.

Thank you for your excellent customer service, and I recommend your products to all my family and friends. Keep up the good work.

Jean Sturgeon

Real Story

+
-

Replay Ad ▶▶

Skip Ad ▶▶

00:00/00:00

UPN	TRADE MARK	PRODUCT DESCRIPTOR	PRODUCT NAME
123456789	Conair	Hot Roller Machine	Hot Roller Machine
123456789	Conair	Hot Roller Machine	Hot Roller Machine
123456789	Conair	Hot Roller Machine	Hot Roller Machine

◀▶
Back
▶▶
Next

Search

FIG. 5059

787/1046

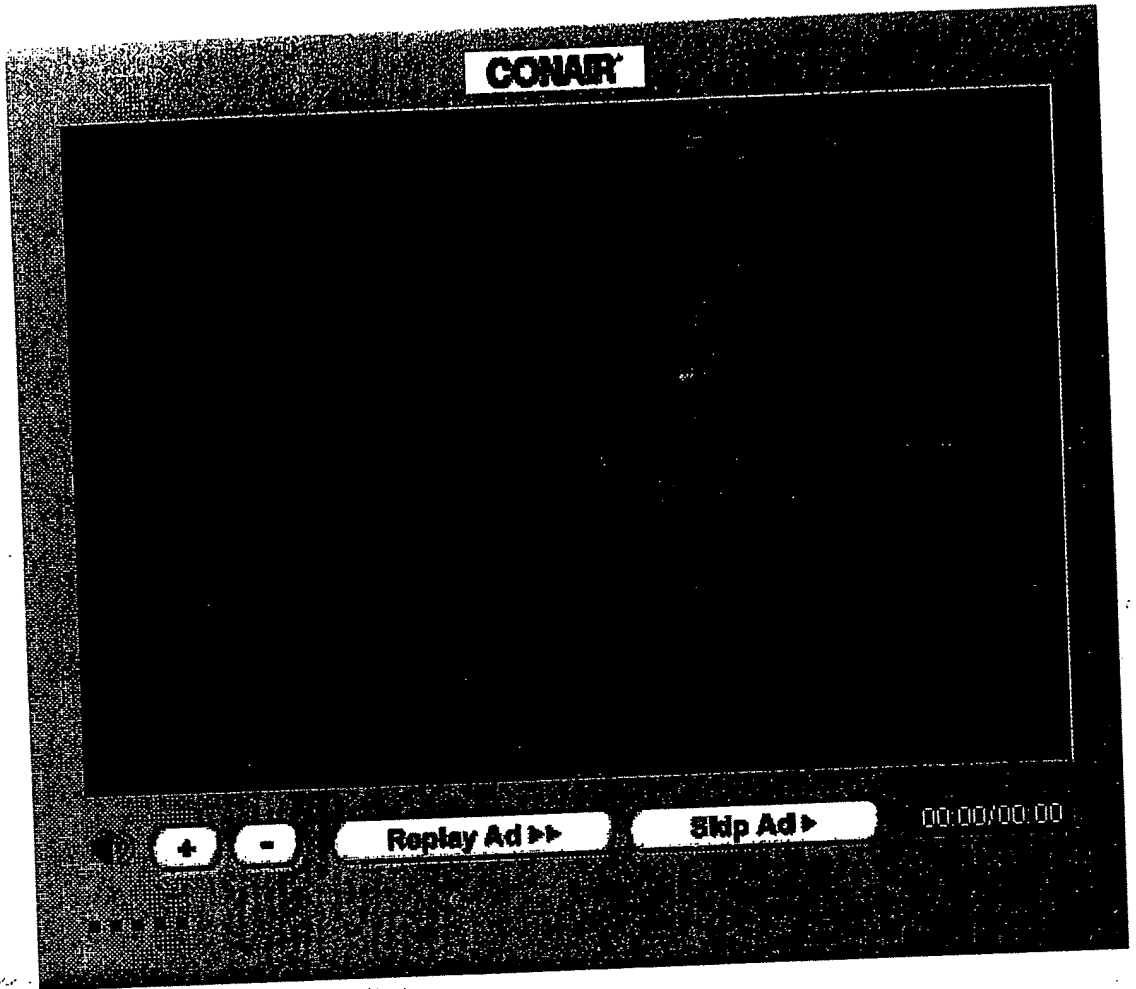

FIG. 50510

738/1046

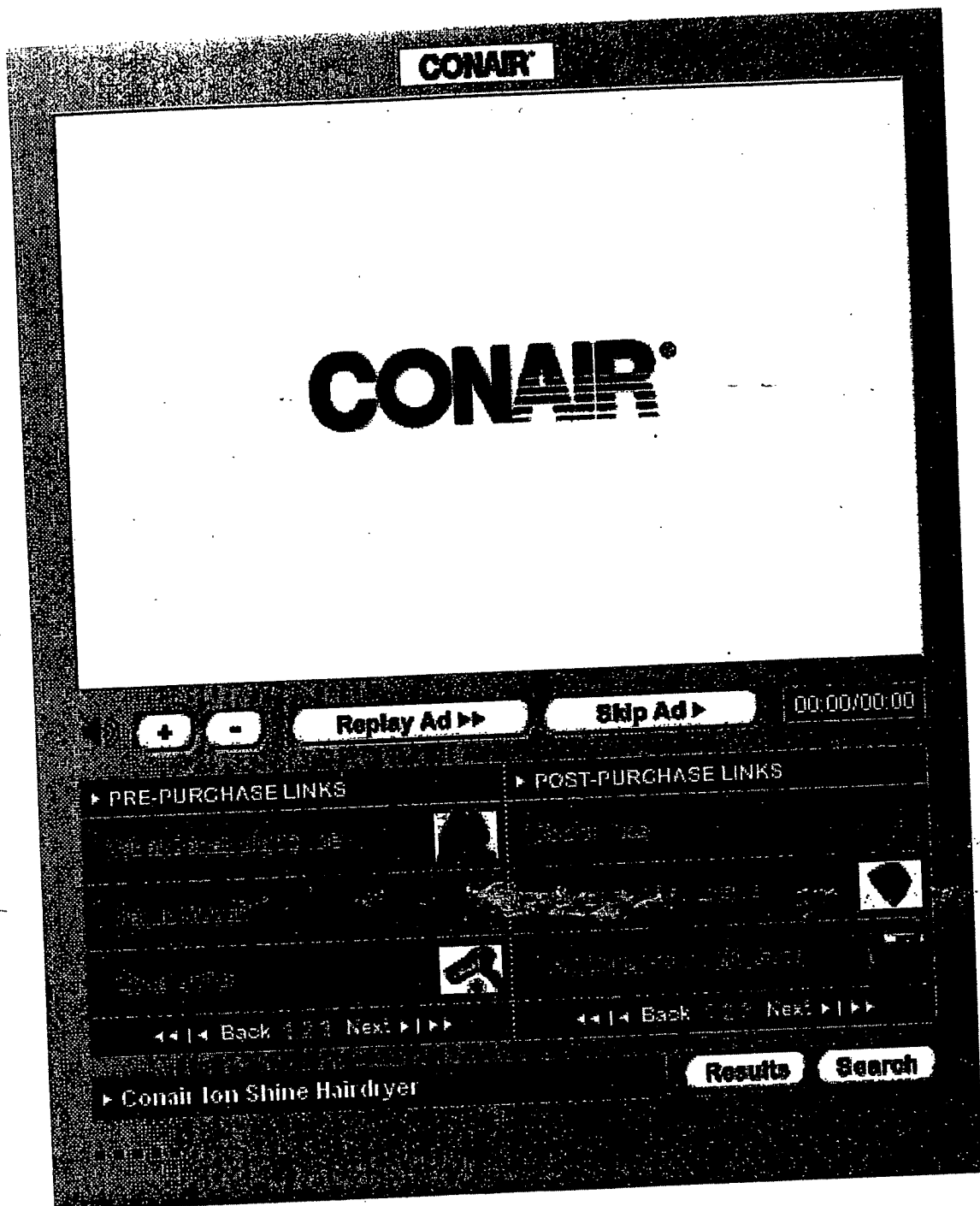

FIG. 50 J11

139/1046

CONAIR

PRODUCTS MARKET PLACE CUSTOMER CARE

Ion Shine
Model 1481



Ion Shine Hair Dryer
Currently in stock.
Typically ships within 24 hours.

Item#: CON 1481 **20% OFF**
Price: \$ 29.99
Promo price: \$ 23.89

[Add to Cart](#) [Email a Friend](#)

Features:

- 1875 Watts of Drying Power
- Full Size
- Ionic Device
- Quiet Tone Motor
- 2 Heat/Speed Settings
- Cool Shot Button

+
-

Replay Ad >>

Skip Ad >

00:00:00:00

► PRE-PURCHASE LINKS

[View Site](#) 

[Product Page](#) 

[Add to Cart](#) 

◀◀ Back | 2/3 | Next ▶▶

► Shop Online

► POST-PURCHASE LINKS

[View Site](#) 

[Product Page](#) 

[Add to Cart](#) 

◀◀ Back | 2/3 | Next ▶▶

RATING 5

[Vote](#) [Search](#)

FIG. 50 J 12



Install Service-Provider-Specific Virtual Kiosks

Control Panel for Installing Service Provider Specific Virtual Kiosks

Standard Demonstration Mode

Control Panel for Installing Service Provider Specific Virtual Kiosks

Client Account: DISNEY

Client Account No: 7145001

User Name: John Smith

Text: R.135

390/1046

FIG. 50K



Control Panel for Installing Service-Provider-Specific Virtual Kiosks

Install Service-Provider-Specific Virtual Kiosks

Standard Demonstration Mode

Client Account: DISNEY

Client Account No: 7145001

User Name: John Smith

The following Service-Provider-Specific Virtual Kiosks are available for installation. Select the Service-Provider-Specific Virtual Kiosks you wish to install by checking the install checkbox. -- for everyone

If there are Service-Provider-Specific Virtual Kiosks available for more than one Service Provider, then the Service-Provider-Specific Virtual Kiosks shall be sorted by Service Provider name. Click "A" to view Service-Provider-Specific Virtual Kiosks from Service Providers beginning with the letter "A", etc. -- for only consumers

Click Next to install the selected Service-Provider-Specific Virtual Kiosks. -- for everyone

Click Search to search for the Service-Provider-Specific Virtual Kiosks associated with a particular Service Provider. -- for only consumers. Below the alphabet bar is also only for consumers. Below the Search button also shall only be visible for consumers.

A B C D E F G H I J K L M N O P Q R S T U V W X Y Z I

1 2 3 4 5 6 7 8 9 10

Service Provider Name	S-P-S Virtual Kiosk Number	S-P-S Virtual Kiosk Serial	S-P-S Virtual Kiosk Name	Launch Environment	Installation Language	Currently Installed	Install
Service Provider Name 1	0900989098-88		Virtual Kiosk Name 1	Deployment Environment 1	Installation language	Currently Installed	<input type="checkbox"/>
Service Provider Name 2	0900989098-88		Virtual Kiosk Name 2	Deployment Environment 2	Installation language	Currently Installed	<input type="checkbox"/>
Service Provider Name 3	0900989098-88		Virtual Kiosk Name 3	Deployment Environment 3	Installation language	Currently Installed	<input type="checkbox"/>
Service Provider Name 4	0900989098-88		Virtual Kiosk Name 4	Deployment Environment 4	Installation language	Currently Installed	<input type="checkbox"/>
Service Provider Name 5	0900989098-88		Virtual Kiosk Name 5	Deployment Environment 5	Installation language	Currently Installed	<input type="checkbox"/>

« | « Back 1 2 3 4 5 Next » | »

Fig. 501



Install Service-Provider-Specific Virtual Kiosks

Control Panel for Installing Service-Provider-Specific Virtual Kiosks

Standard Demonstration Mode

Search for Service Provider

Client Account: DISNEY

Client Account No: 7145001

User Name: John Smith

Search for the Service Provider whose Service-Provider-Specific Virtual Kiosks you wish to install. Click Next to initiate the Service Provider search.

Search for:

Search by: Service Provider Name



FA2/1046

Back

Next

FIG. 50 L 2

Control Panel for Installing Service Provider Specific Virtual Kiosks



Install Service-Provider-Specific Virtual Kiosks

Standard Demonstration Mode

SELECT A SERVICE PROVIDER

Client Account: DISNEY | Client Account No: 7145001 | User Name: John Smith

The following Service Providers matched your search criteria and have Service-Provider-Specific Virtual Kiosks available to install. Click on the Service Provider Name to view Service-Provider-Specific Virtual Kiosks for the selected Service Provider.

Service Provider Name	Service Provider Identification Number (SPIN)	No. of Virtual Kiosks
<u>Service Provider Name_1</u>	SPIN 1	Virtual Kiosk No 1
<u>Service Provider Name_1</u>	SPIN 1	Virtual Kiosk No 2
<u>Service Provider Name_1</u>	SPIN 1	Virtual Kiosk No 3
<u>Service Provider Name_1</u>	SPIN 1	Virtual Kiosk No 4
<u>Service Provider Name_1</u>	SPIN 1	Virtual Kiosk No 5

743/1046

Back

FIG. 50 L 3

http://www.brandkey.com/bk-deliver/m-install_service-provider-3.html
file://E:\www\brandkey\bk_deliver\TM\PD9gsuvcfb3.htm



Control Panel for Installing Service-Provider-Specific Virtual Kiosks

Install Service-Provider-Specific Virtual Kiosks

Download Virtual Kiosk Tool

Standard Demonstration Mode

Client Account: DISNEY | Client Account No: 7145001 | User Name: John Smith

The following information is required before you can download the installation files for the Service-Provider-Specific Virtual Kiosks. This information is used by Service Providers and their agents to better customize the Service-Provider-Specific Virtual Kiosks for your needs.

User Name:

Installation Domain: (e.g. www.virtualkiosklaunchsite.com)

Physical Location:

City:

State: -- Select One --

Zip/Postal Code:

Country: United States

Purpose of Installation:

196/1046



FIG. 50LS



Install Service-Provider-Specific Virtual Kiosks

Control Panel for Installing Service-Provider-Specific Virtual Kiosks

Standard Demonstration Mode

Client Account: DISNEY

Client Account No: 7145001

User Name: John Smith

The setup files for the following Service-Provider-Specific Virtual Kiosk(s) have been prepared. You have selected Service-Provider-Specific Virtual Kiosk(s) that are Launchable from the following environments.

Launch Environment	Selected	
HTML-Embedded Default Logo	<input checked="" type="checkbox"/>	Download Kiosks
HTML-Embedded Document	<input checked="" type="checkbox"/>	Download Kiosks
HTML-Encoded Image	<input checked="" type="checkbox"/>	Download Kiosks
HTML-Encoded Desktop Icon	<input checked="" type="checkbox"/>	Download Kiosks

746/9046

FIG. 50L6

747/1046



Members & Families

Brokers & Partners

Physicians & Providers

Navigation: Home, Search, Reply Ad, Skip Ad

749/1046

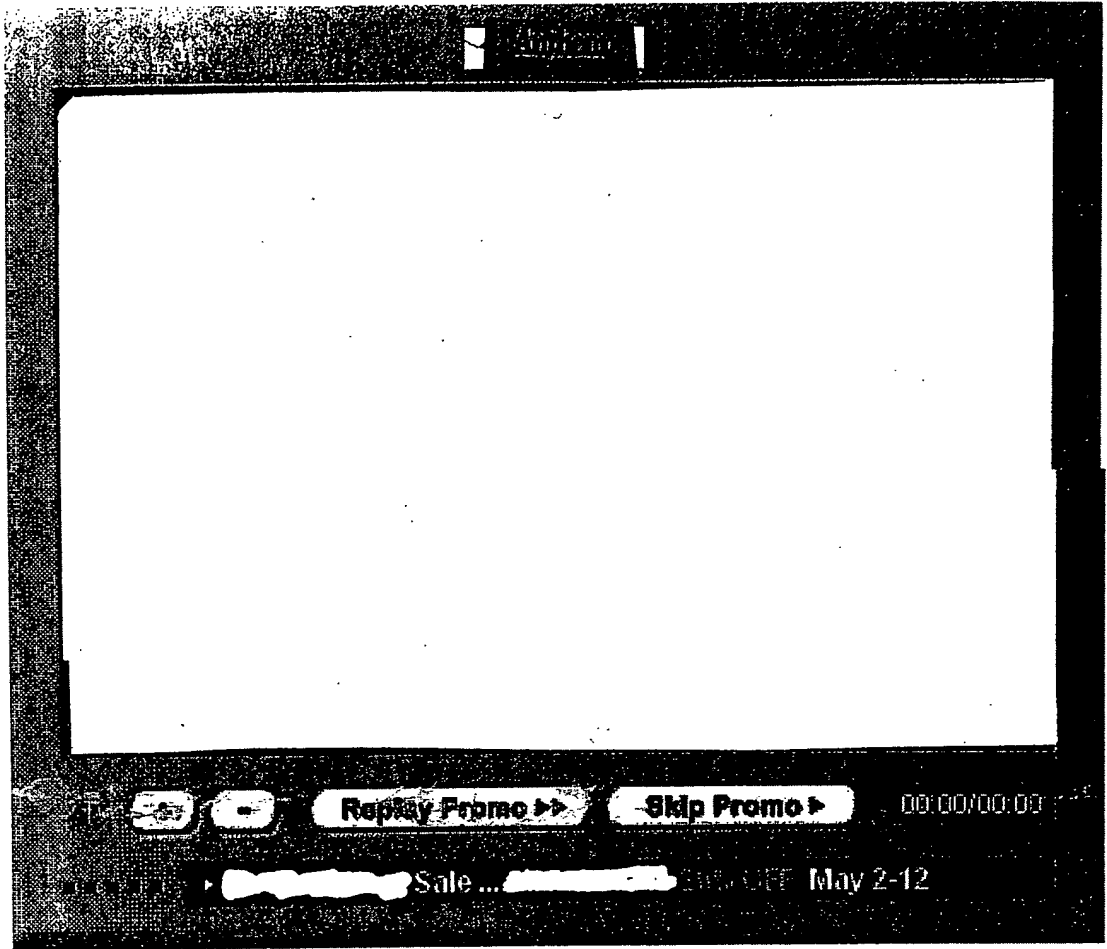

FIG. 50G2

799/1046

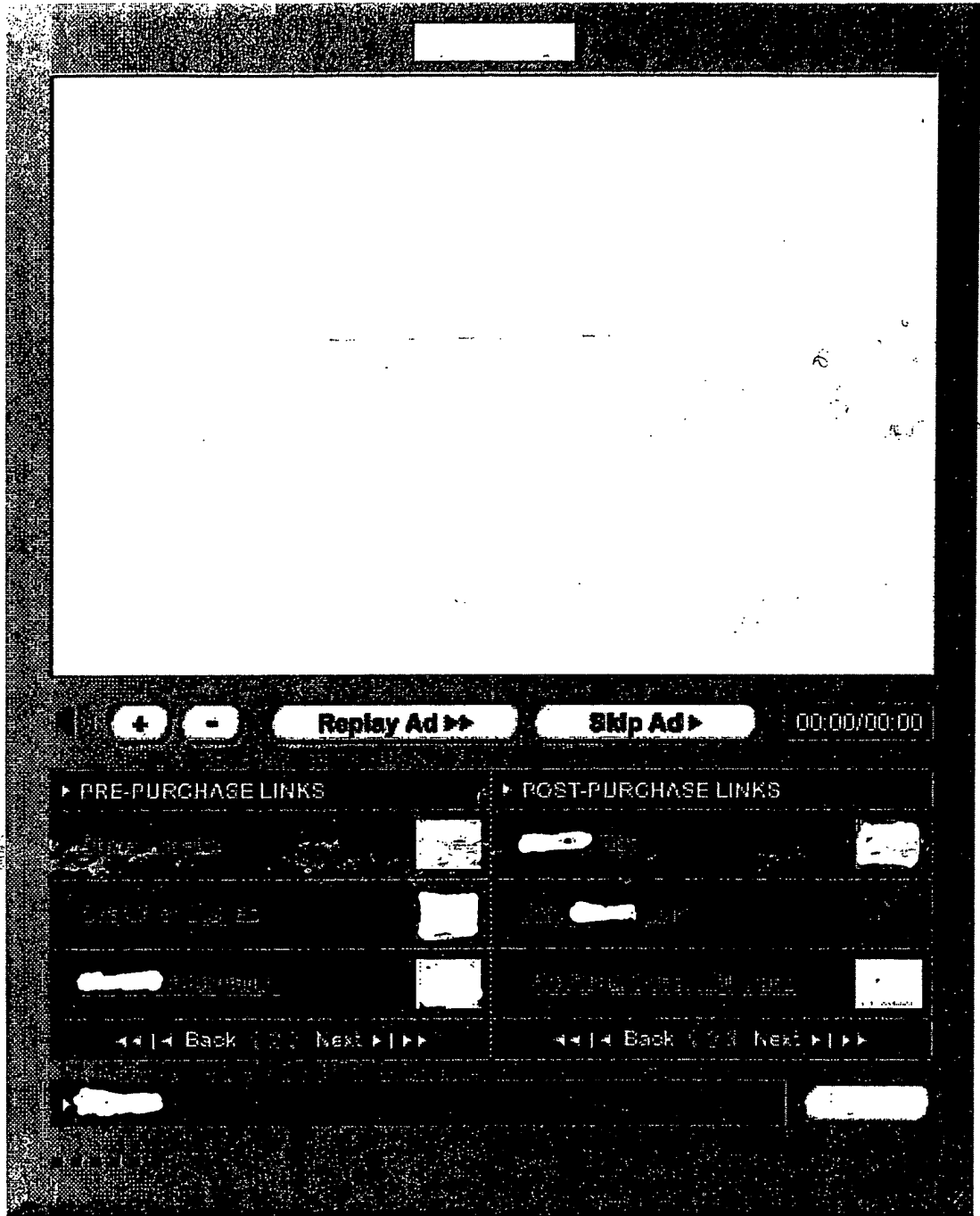

FIG 50 Q3

755/1046

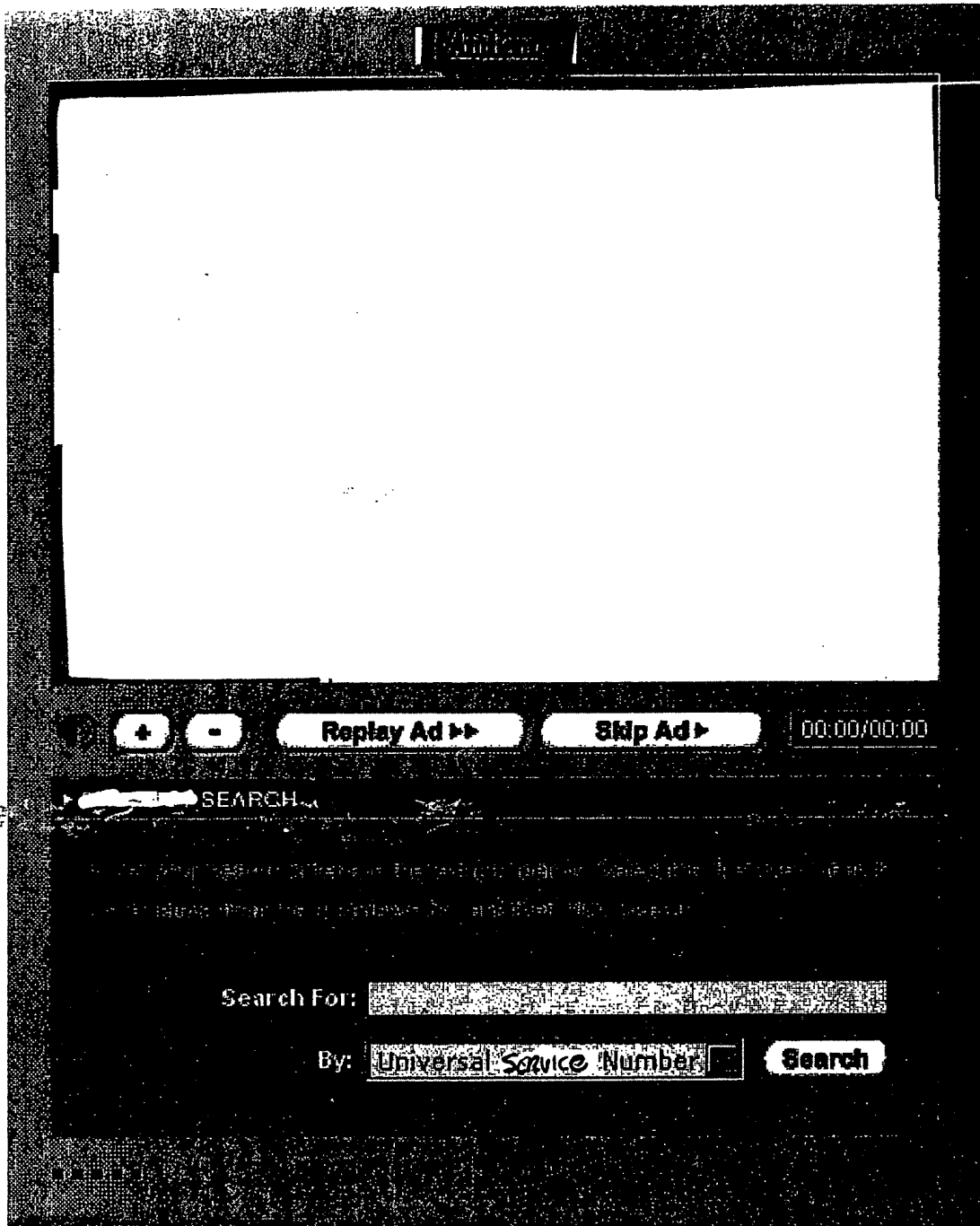

FIG. 506 4



Control Panel for Installing Retailer-Specific Virtual Kiosks

Install Retailer-Specific Virtual Kiosks

Standard Demonstration Mode

CONTROL PANEL FOR INSTALLING RETAILER-SPECIFIC VIRTUAL KIOSKS

Client Account: DISNEY

Client Account No: 7145001

User Name: John Smith

Text: R.135

FS/1046

FIG. 50 N



Install Retailer-Specific Virtual Kiosks

Control Panel for Installing Retailer-Specific Virtual Kiosks

Standard Demonstration Mode

Client Account: DISNEY

Client Account No: 7145001

User Name: John Smith

The following Retailer-Specific Virtual Kiosks are available for installation. Select the Retailer-Specific Virtual Kiosks you wish to install by checking the install checkbox. -- for everyone

If there are Retailer-Specific Virtual Kiosks available for more than one Retailer, then the Retailer-Specific Virtual Kiosks shall be sorted by Retailer name. Click 'A' to view Retailer-Specific Virtual Kiosks from Retailers beginning with the letter 'A', etc. -- for only consumers

Click Next to install the selected Retailer-Specific Virtual Kiosks. -- for everyone

Click Search to search for the Retailer-Specific Virtual Kiosks associated with a particular Retailer. -- for only consumers. Below the alphabet bar is also only for consumers. Below the Search button also shall only be visible for consumers.

A B C D E F G H I J K L M N O P Q R S T U V W X Y Z I

1 1 1 2 1 3 1 4 1 5 1 6 1 7 1 8 1 9 1 0 1

752/1046

Retailer Name	R-S Virtual Kiosk Serial Number	R-S Virtual Kiosk Name	Launch Environment	Installation Language	Currently Installed	Install
Retailer Name 1	0900989098-88	Virtual Kiosk Name 1	Deployment Environment 1	Installation language	Currently Installed	<input type="checkbox"/>
Retailer Name 2	0900989098-88	Virtual Kiosk Name 2	Deployment Environment 2	Installation language	Currently Installed	<input type="checkbox"/>
Retailer Name 3	0900989098-88	Virtual Kiosk Name 3	Deployment Environment 3	Installation language	Currently Installed	<input type="checkbox"/>
Retailer Name 4	0900989098-88	Virtual Kiosk Name 4	Deployment Environment 4	Installation language	Currently Installed	<input type="checkbox"/>
Retailer Name 5	0900989098-88	Virtual Kiosk Name 5	Deployment Environment 5	Installation language	Currently Installed	<input type="checkbox"/>

Back 1 2 3 4 5 Next >>>

Search Next

FIG.5001



Control Panel for installing Retailer-Specific Virtual Kiosks

Install Retailer-Specific Virtual Kiosks

Download Virtual Kiosk

Standard Demonstration Mode

Search for Vendor

Client Account: DISNEY

Client Account No: 7145001

User Name: John Smith

Search for the Vendor whose Retailer-Specific Virtual Kiosks you wish to install. Click Next to initiate the Vendor search.

Search for:

Search by: Vendor Name



753/1046

Back

Next

FIG. 5002



Central Panel for Installing Retailer Specific Virtual Kiosks

Install Retailer-Specific Virtual Kiosks

Download Virtual Kiosk Software

Standard Demonstration Mode

Client Account: DISNEY | Client Account No: 7145001 | User Name: John Smith

The following Vendors matched your search criteria and have Retailer-Specific Virtual Kiosks available to install. Click on the Vendor Name to view Retailer-Specific Virtual Kiosks for the selected Vendor.

Vendor Name	MIN	No. of Virtual Kiosks
Vendor Name 1	MIN 1	Virtual Kiosk No 1
Vendor Name 2	MIN 2	Virtual Kiosk No 2
Vendor Name 3	MIN 3	Virtual Kiosk No 3
Vendor Name 4	MIN 4	Virtual Kiosk No 4
Vendor Name 5	MIN 5	Virtual Kiosk No 5

754/1046

FIG. 5003

http://www.brandkey.com/bk_deliver/m_install_retailer-3.html

file:///E:/www/brandkey/bk_deliver/TMP915kccsfv.htm



Install Pats Jar Specific Virtual Kiosks

Control Panel for Installing Retailer Specific Virtual Kiosks

Standard Demonstration Mode

Client Account: DISNEY

Client Account No: 7145001

User Name: John Smith

755/1046

Here will go the License Agreement. Here will go the License Agreement. Here will go the License Agreement. Here will go the License Agreement. Here will go the License Agreement. Here will go the License Agreement. Here will go the License Agreement. Here will go the License Agreement. Here will go the License Agreement. Here will go the License Agreement.

Back Agree

FIG. 50 04



Install Retailer-Specific Virtual Kiosks

Control Panel for Installing Retailer-Specific Virtual Kiosks

Standard Demonstration Mode

Client Account: DISNEY | Client Account No: 7145001 | User Name: John Smith

The following information is required before you can download the installation files for the Retailer-Specific Virtual Kiosks. This information is used by Vendors and their agents to better customize the Retailer-Specific Virtual Kiosks for your needs.

User Name:

Installation Domain:

Physical Location:

City:

State:

Zip/Postal Code:

Country:

Purpose of Installation:

756/1046

FIG. 50 05



Control Panel for Installing Retailer-Specific Virtual Kiosks

Install Retailer-Specific Virtual Kiosks

Standard Demonstration Mode

DISNEY

Client Account: DISNEY | Client Account No: 7145001 | User Name: John Smith

The setup files for the selected Retailer-Specific Virtual Kiosk(s) have been prepared. You have selected Retailer-Specific Virtual Kiosk(s) that are Launchable from the following environments.

Launch Environment	Selected
HTML-Embedded Default Logo	<input checked="" type="checkbox"/>
HTML-Embedded Document	<input checked="" type="checkbox"/>
HTML-Encoded Image	<input checked="" type="checkbox"/>
HTML-Encoded Desktop Icon	<input checked="" type="checkbox"/>

15771046

FIG. 5006

758/1046

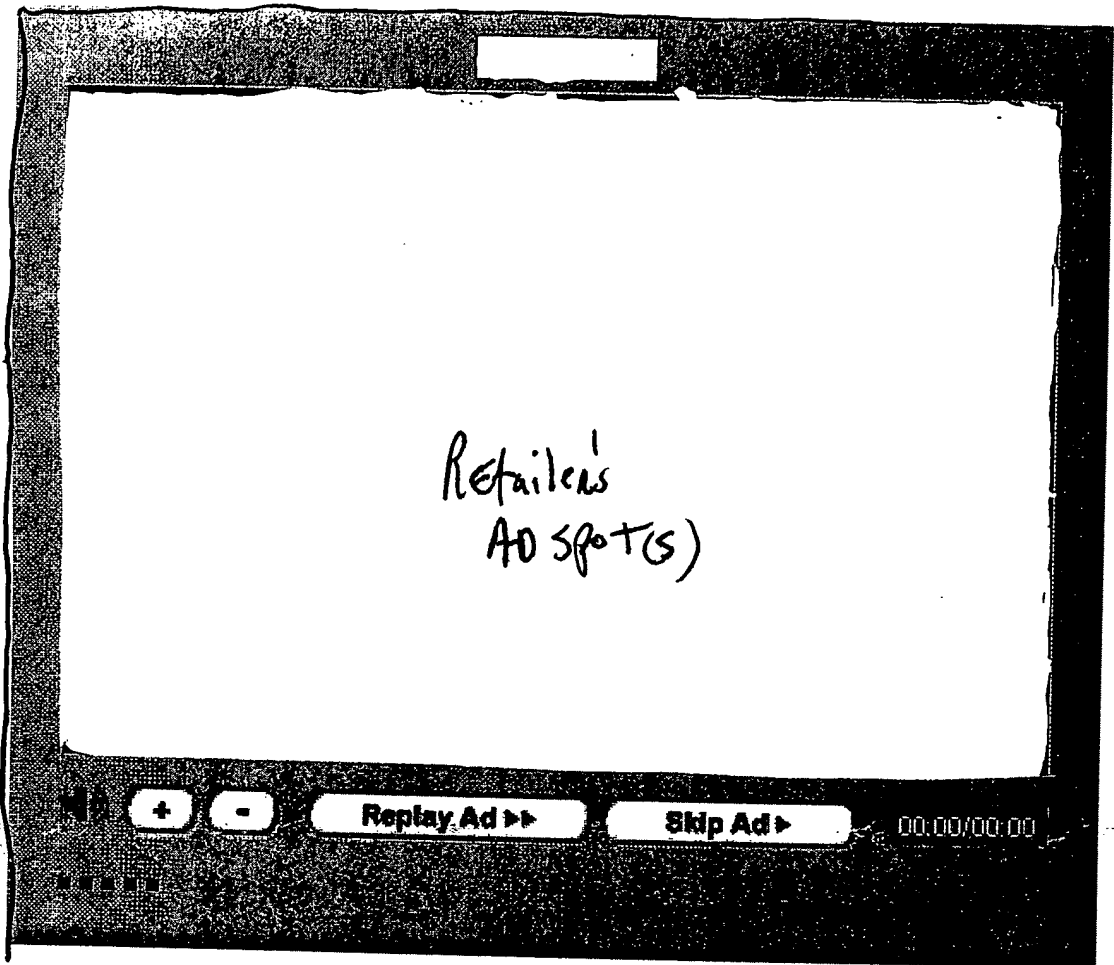

FIG. 50.P1

759/1046

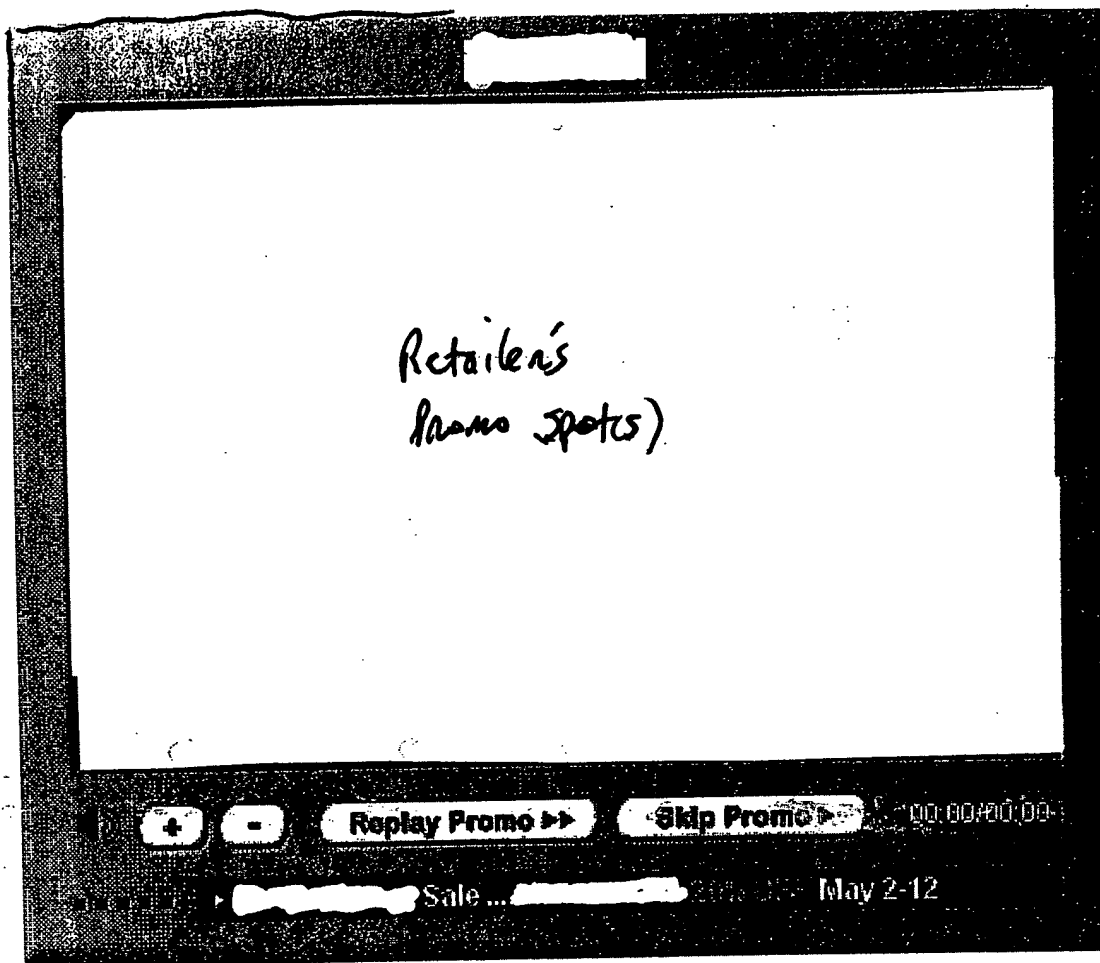

FIG. 50 P2

FIG. 50 P3

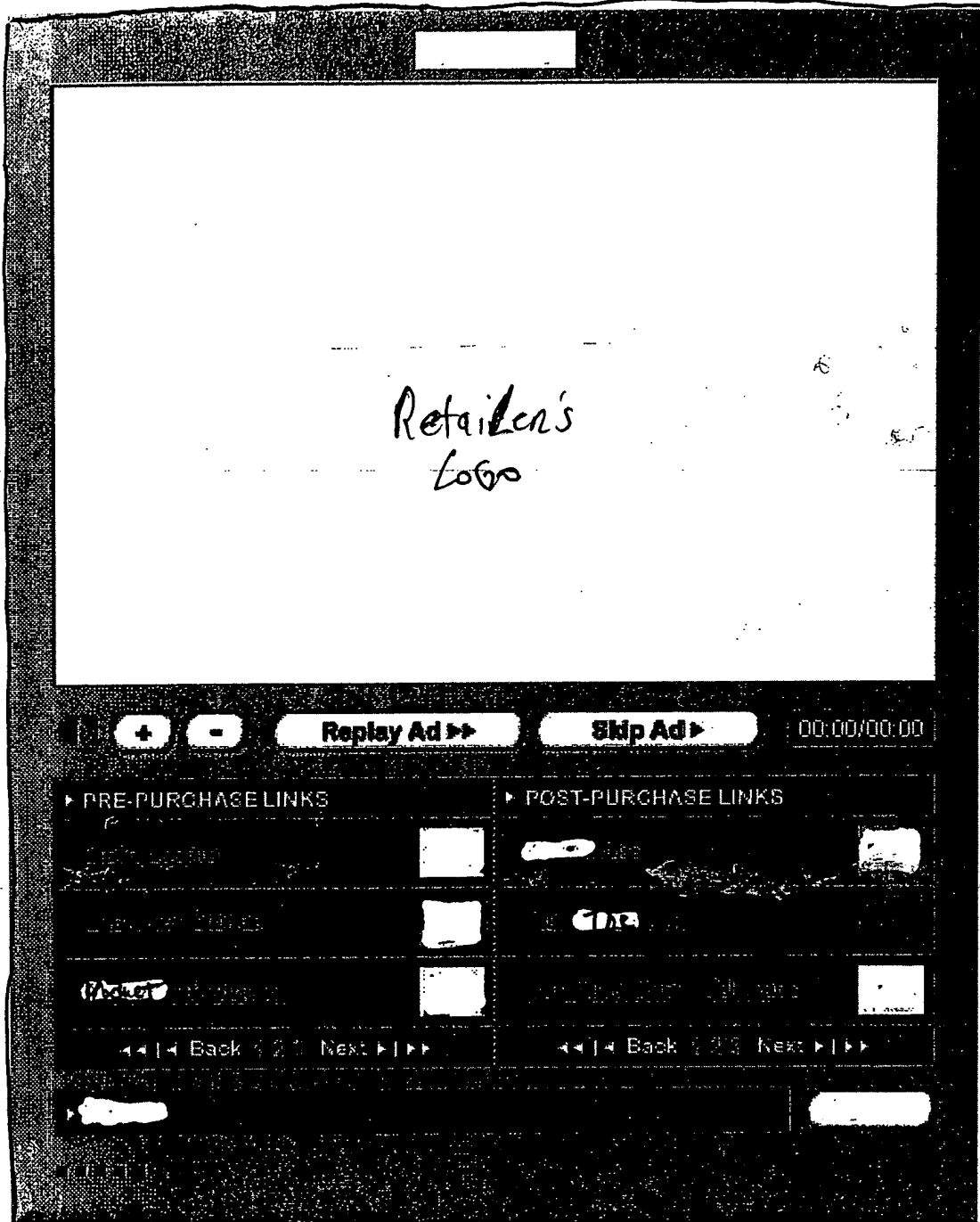

FIG. 50 P3

7611046

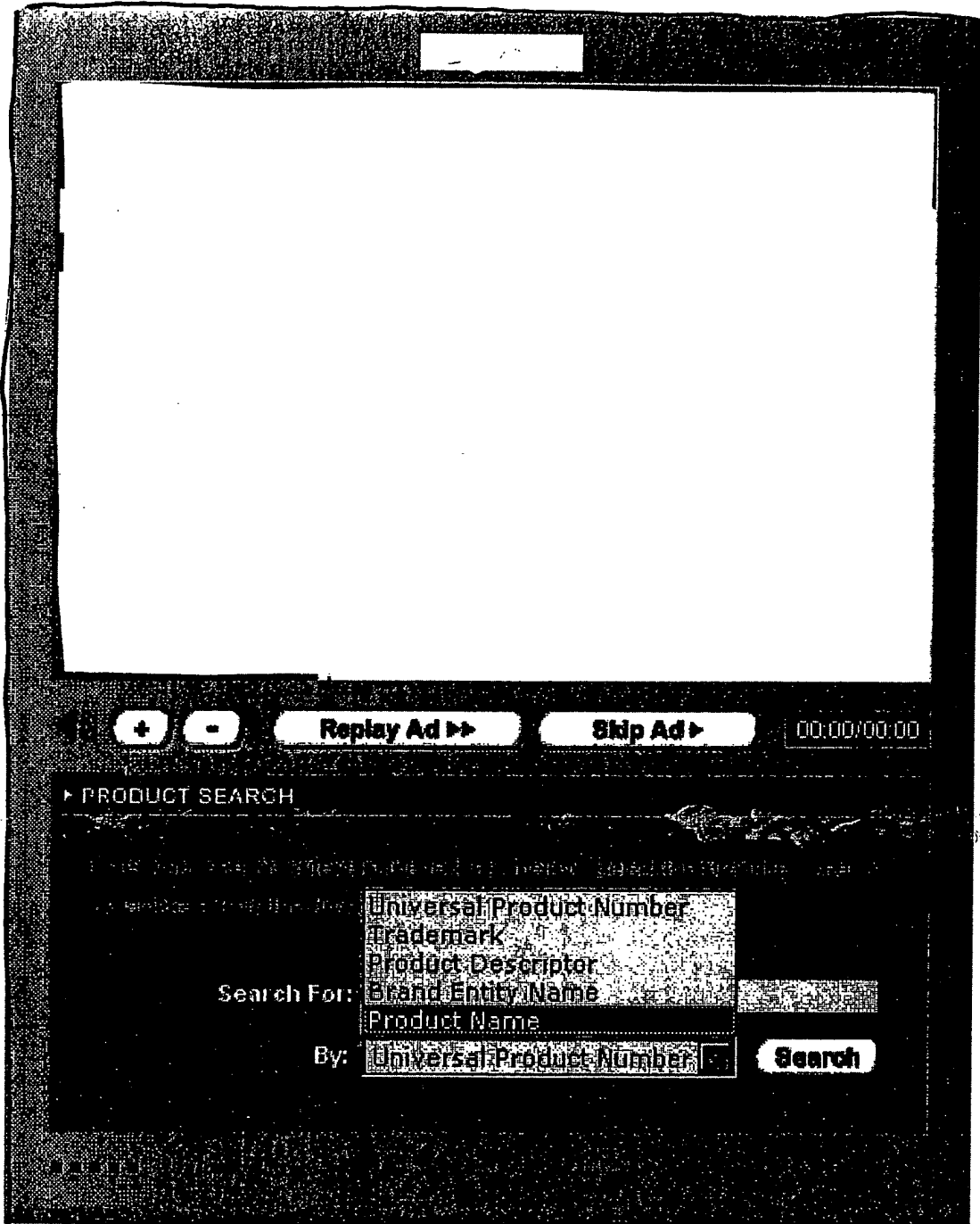

FIG. 50 A4

702/1046

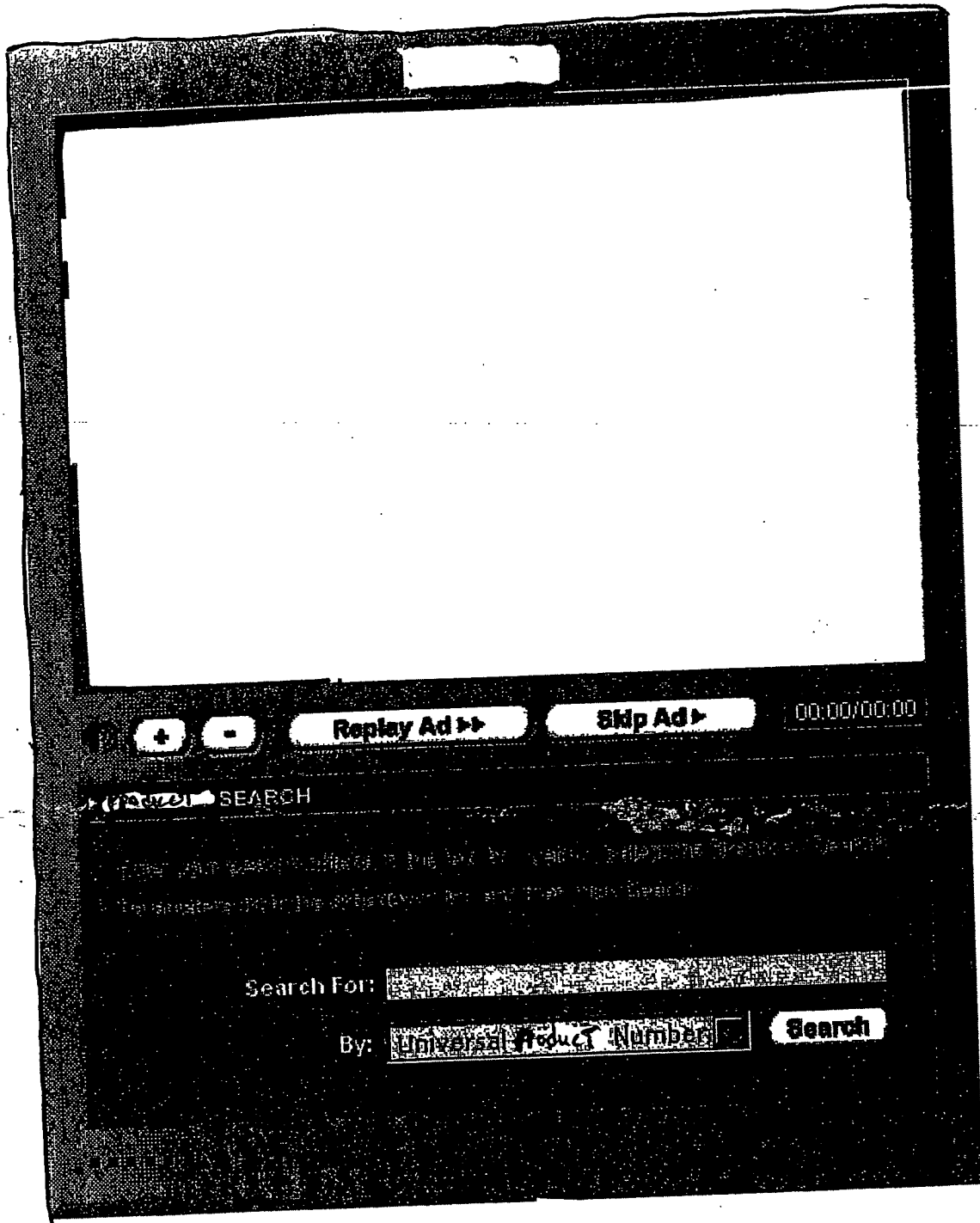

FIG. 50 P5

103/1040

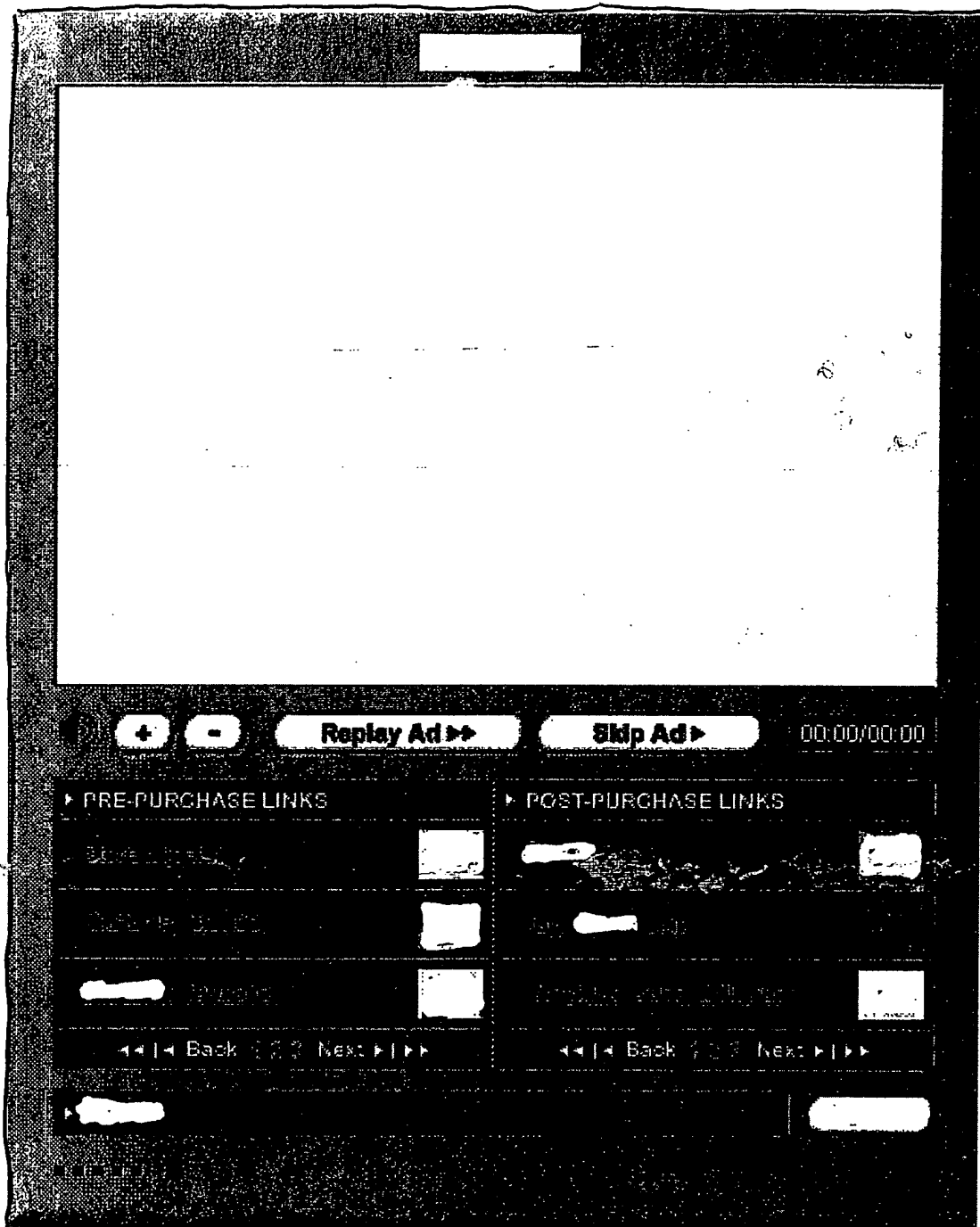

FIG. 50 P6



Install Industry-Specific Virtual Kiosks

Control Panel for installing Industry-Specific Virtual Kiosks

Standard Demonstration Mode

Client Account: DISNEY

Client Account No: 7145001

User Name: John Smith

Text: R.135

764/1046

FIG. 50Q



Install Industry-Specific Virtual Kiosks

Control Panel for Installing Industry-Specific Virtual Kiosks

Standard Demonstration Mode

Client Account: DISNEY

Client Account No: 7145001

User Name: John Smith

The following Industry-Specific Virtual Kiosks are available for installation. Select the Industry-Specific Virtual Kiosks you wish to install by checking the install checkbox. -- for everyone

If there are Industry-Specific Virtual Kiosks available for more than one industrialist, then the Industry-Specific Virtual Kiosks shall be sorted by industrialist name. Click 'A' to view Industry-Specific Virtual Kiosks from industrialists beginning with the letter 'A', etc. -- for only consumers

Click Next to install the selected Industry-Specific Virtual Kiosks. -- for everyone

Click Search to search for the Industry-Specific Virtual Kiosks associated with a particular industrialist. -- for only consumers. Below the alphabet bar is also only for consumers. Below the Search button also shall only be visible for consumers.

A B C D E F G H I J K L M N O P Q R S T U V W X Y Z I

1 1 1 2 1 3 1 4 1 5 1 6 1 7 1 8 1 9 1 0 1

765/1046

Industrialist Name	P-S Virtual Kiosk Number	P-S Virtual Kiosk Serial	Virtual Kiosk Name	Launch Environment	Installation Language	Currently Installed	Install
Industrialist Name 1	0900989098-88		Virtual Kiosk Name 1	Deployment Environment 1	Installation language	Currently Installed	<input type="checkbox"/>
Industrialist Name 2	0900989098-88		Virtual Kiosk Name 2	Deployment Environment 2	Installation language	Currently Installed	<input type="checkbox"/>
Industrialist Name 3	0900989098-88		Virtual Kiosk Name 3	Deployment Environment 3	Installation language	Currently Installed	<input type="checkbox"/>
Industrialist Name 4	0900989098-88		Virtual Kiosk Name 4	Deployment Environment 4	Installation language	Currently Installed	<input type="checkbox"/>
Industrialist Name 5	0900989098-88		Virtual Kiosk Name 5	Deployment Environment 5	Installation language	Currently Installed	<input type="checkbox"/>

◀◀ | ◀ Back 1 2 3 4 5 Next ▶▶

Search Next

FIG. 50 R1



Control Panel for Installing Industry-Specific Virtual Klosets

Install Industry-Specific Virtual Klosets

Standard Demonstration Mode

Search for Vendor

Client Account: DISNEY

Client Account No: 7145001

User Name: John Smith

Search for the Vendor whose Industry-Specific Virtual Klosets you wish to install. Click Next to initiate the Vendor search.

Search for:

Search by: Vendor Name



100/1046

DISK

NEXT

FIG. 50 RZ

Control Panel for installing Industry-Specific Virtual Kiosks



Install Industry-Specific Virtual Kiosks

Download Virtual Kiosk Tool

Standard Demonstration Mode

Select Vendor

Client Account: DISNEY Client Account No: 7145001 User Name: John Smith

The following Vendors matched your search criteria and have Industry-Specific Virtual Kiosks available to install. Click on the Vendor Name to view Industry-Specific Virtual Kiosks for the selected Vendor.

Vendor Name	Vendor Identification Number (MIN)	No. of Virtual Kiosks
<u>Vendor Name.1</u>	MIN 1	Virtual Kiosk No 1
<u>Vendor Name.2</u>	MIN 2	Virtual Kiosk No 2
<u>Vendor Name.3</u>	MIN 3	Virtual Kiosk No 3
<u>Vendor Name.4</u>	MIN 4	Virtual Kiosk No 4
<u>Vendor Name.5</u>	MIN 5	Virtual Kiosk No 5

767/1046

FIG 50R3

http://www.brandkey.com/bk_deliver/m_install/industry-3.html

file:///E:/www/brandkey/bk_deliver/FF9K0qbesffa.htm



Install Industry-Specific Virtual Kiosks

Control Panel for Installing Industry-Specific Virtual Kiosks

Standard Demonstration Mode

Client Account: DISNEY | Client Account No: 7145001 | User Name: John Smith

The following information is required before you can download the installation files for the Industry-Specific Virtual Kiosks. This information is used by Vendors and their agents to better customize the Industry-Specific Virtual Kiosks for your needs.

User Name:

Installation Domain:

 (e.g. www.virtualkiosklaunchsite.com)

Physical Location:

City:

State:

 -- Select One --

Zip/Postal Code:

Country:

 United States

Purpose of Installation:

Back Next

FIG. 50R5

769/1046



Install Industry-Specific Virtual Kiosks

Control Panel for Installing Industry-Specific Virtual Kiosks

Standard Demonstration Mode

Client Account: DISNEY

Client Account No: 7145001

User Name: John Smith

Download Virtual Kiosk Files

The setup files for the selected Industry-Specific Virtual Kiosk(s) have been prepared. You have selected Industry-Specific Virtual Kiosk(s) that are Launchable from the following environments.

Launch Environment	Selected
HTML-Embedded Default Logo	<input checked="" type="checkbox"/>
HTML-Embedded Document	<input checked="" type="checkbox"/>
HTML-Encoded Image	<input checked="" type="checkbox"/>
HTML-Encoded Desktop Icon	<input checked="" type="checkbox"/>

770/1046

FIG. 50R6

771/1046

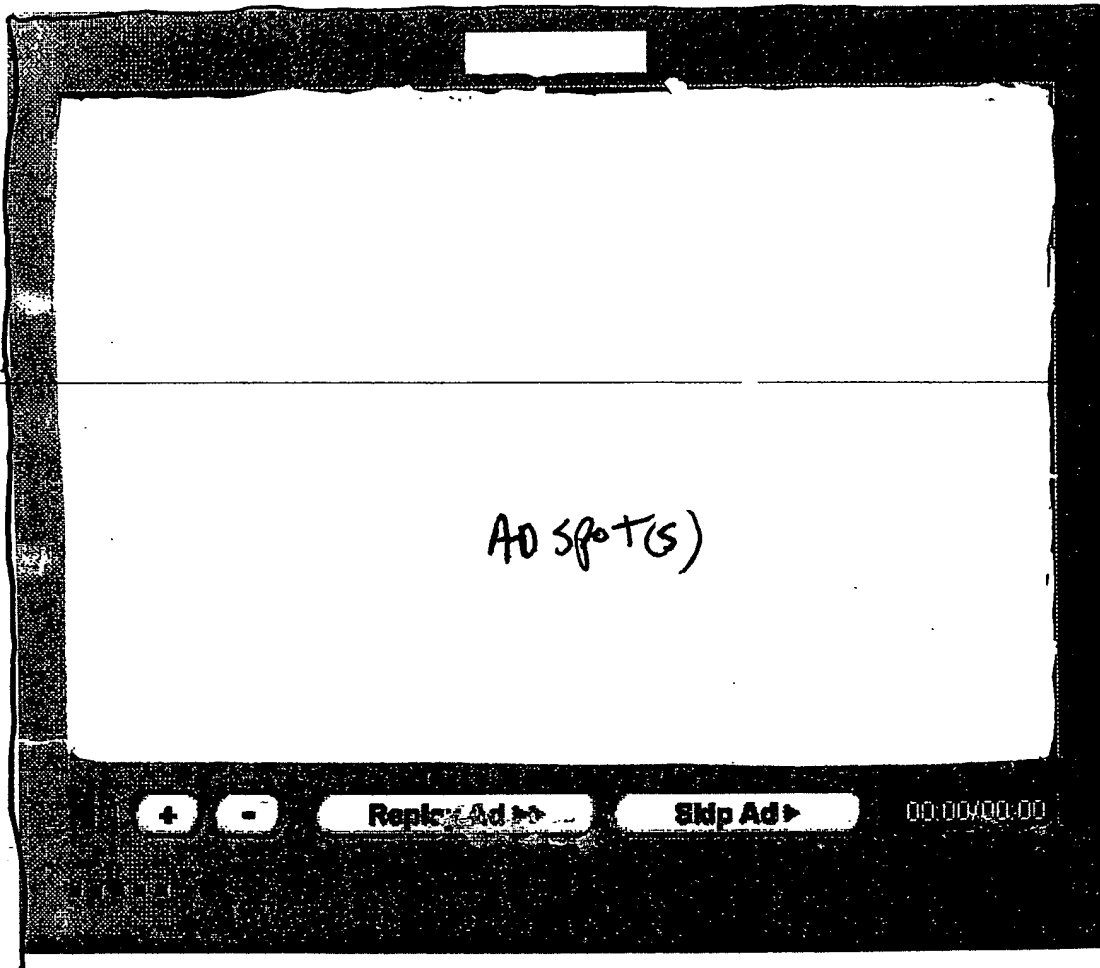

FIG. 50S1

772/1046

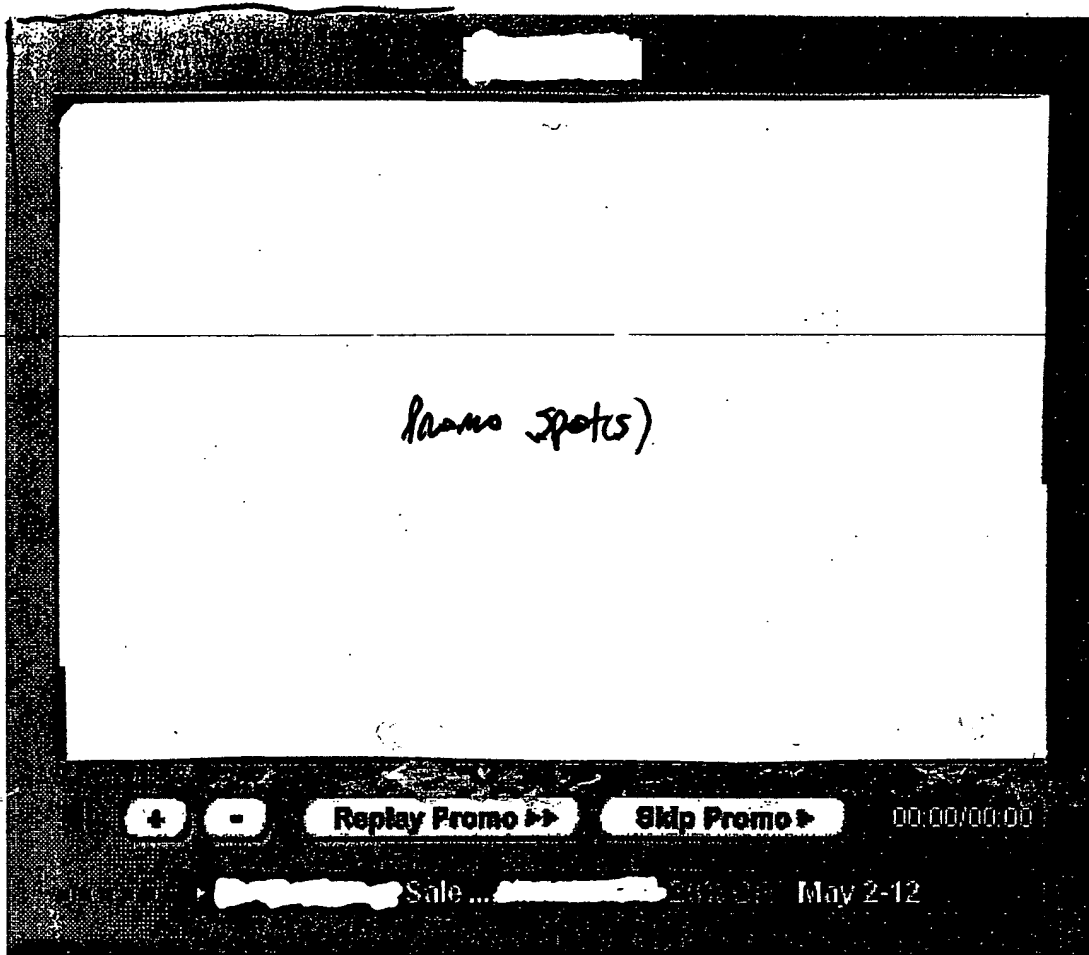

FIG. 5052

7/23/046

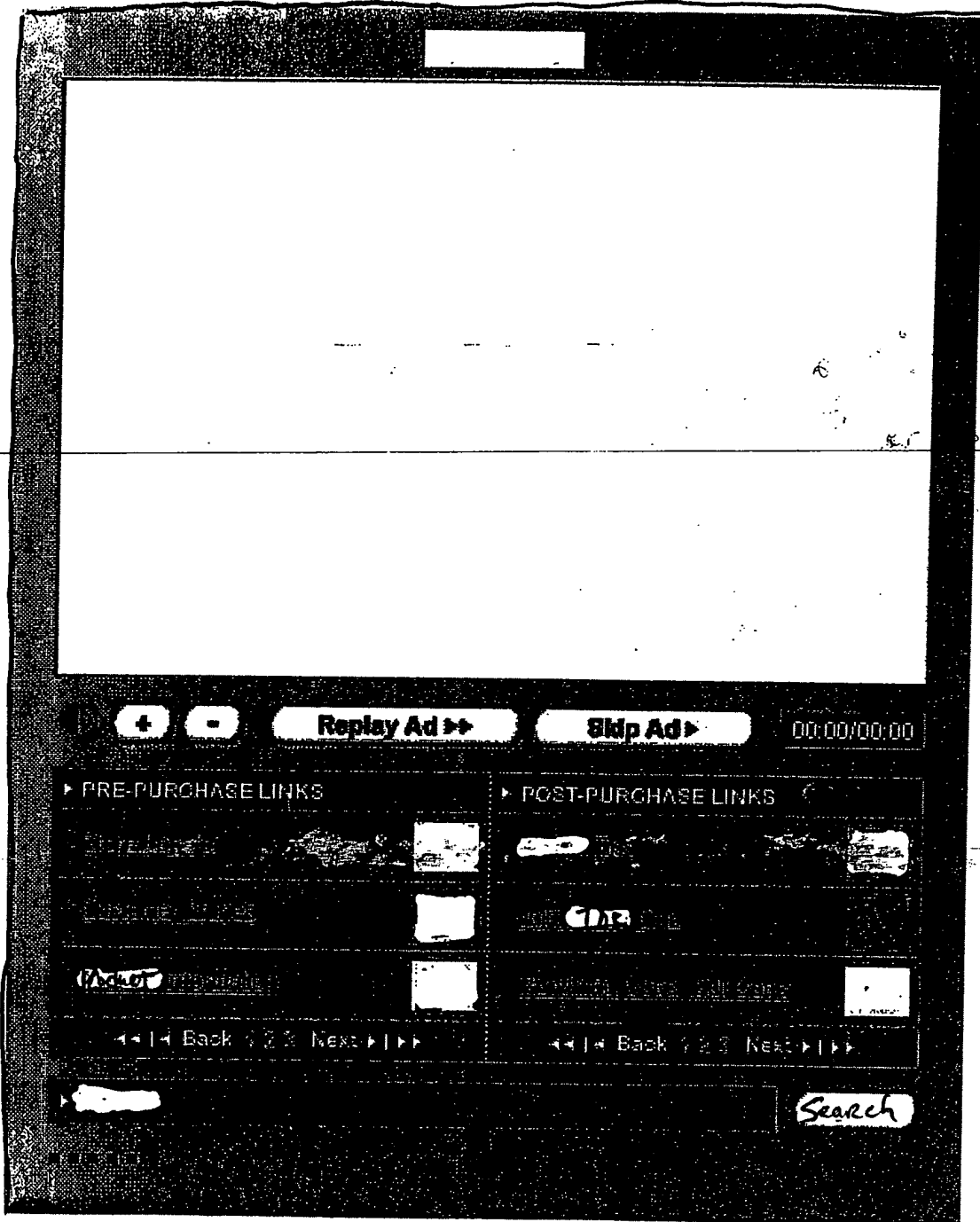

FIG. 50 53

774/1040

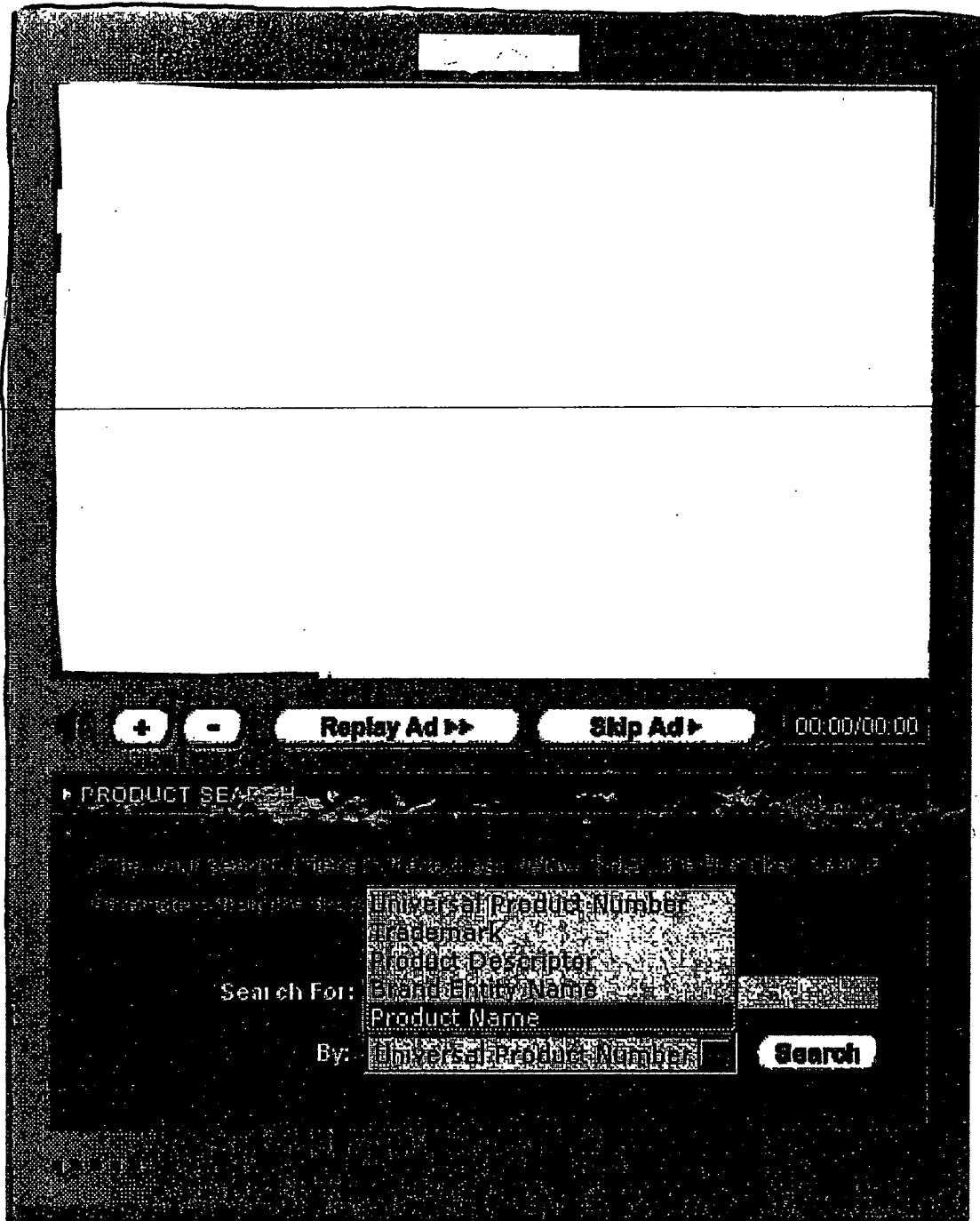

FIG. 50 54

775/1040

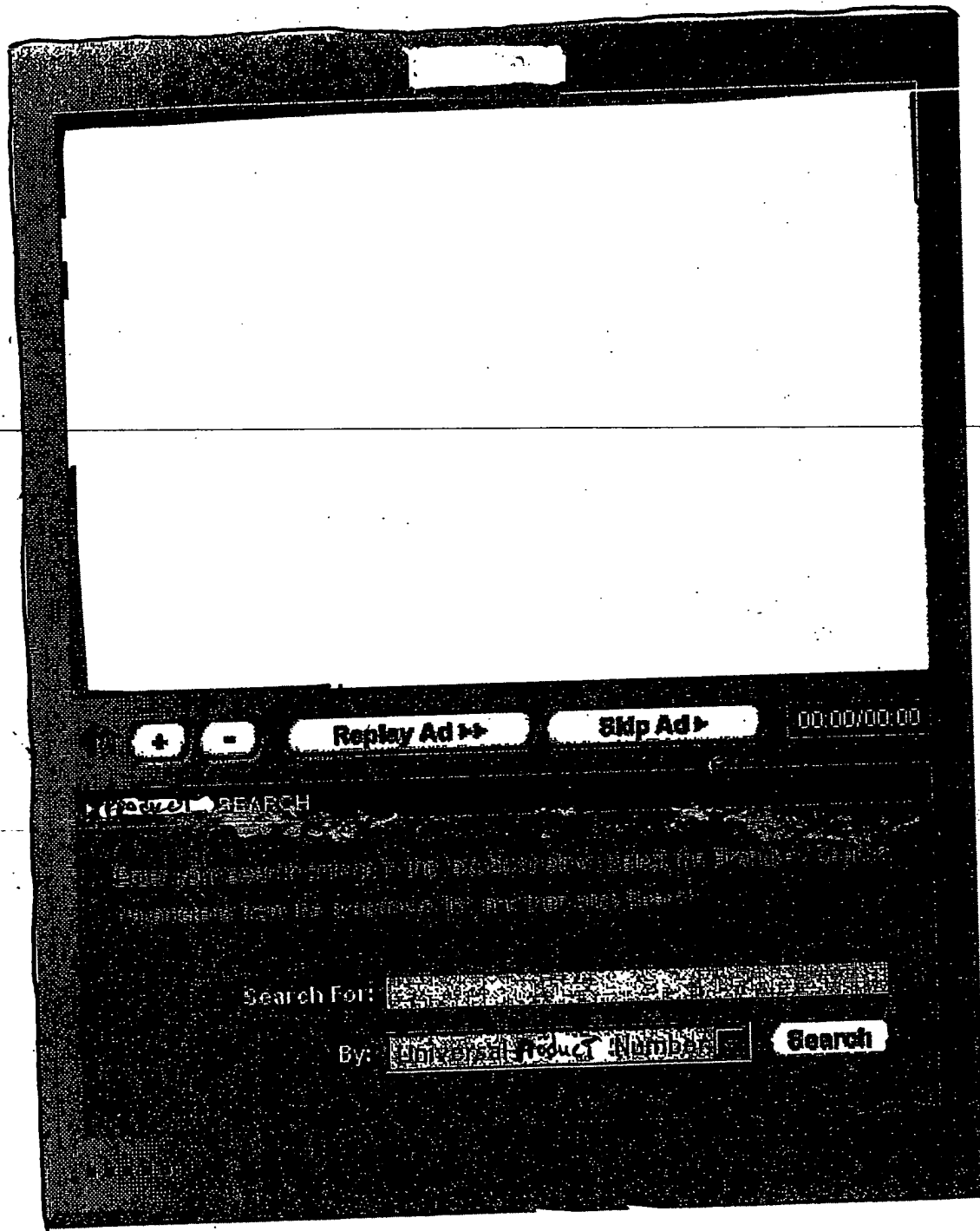

FIG. 50 S5

776/1046

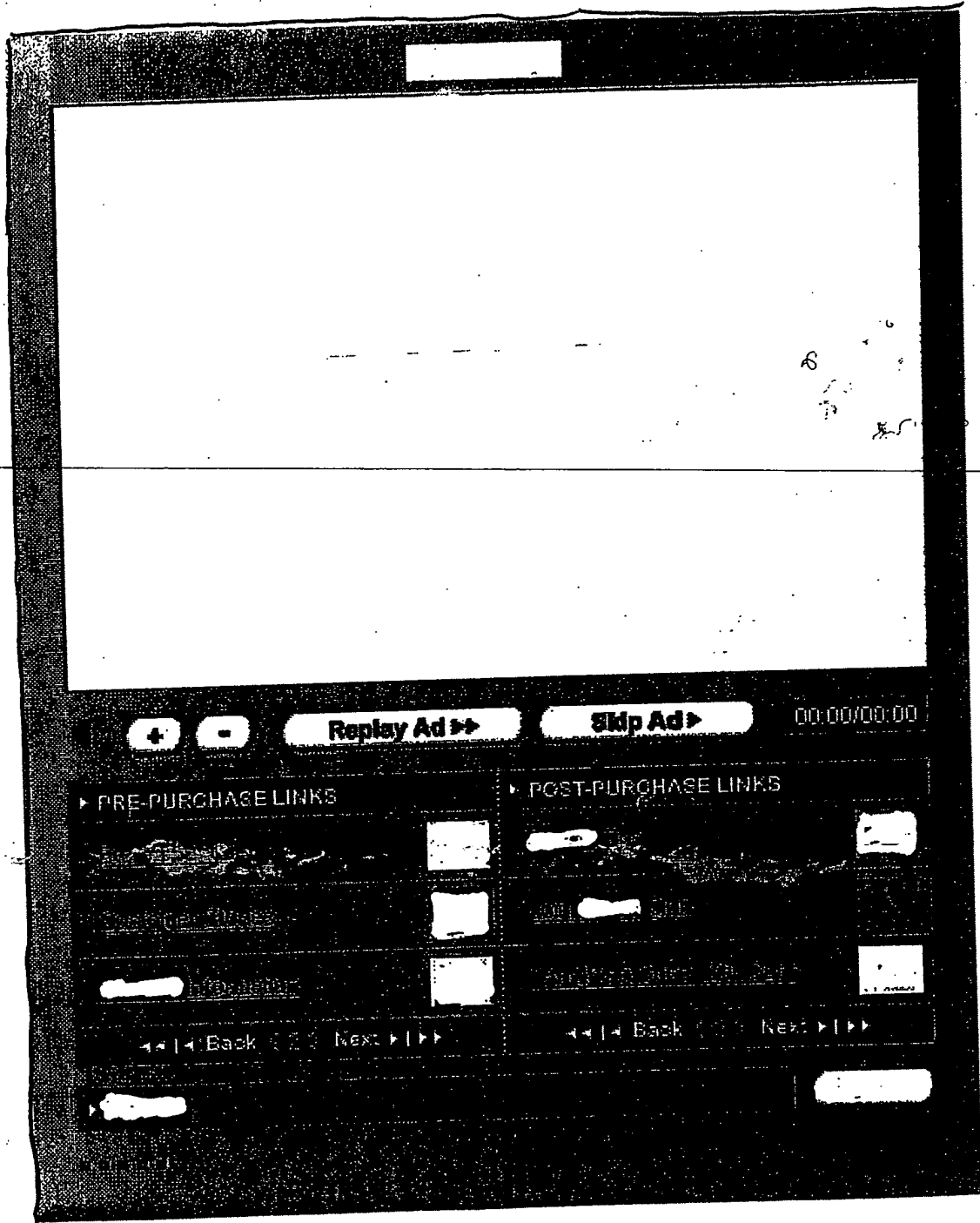

FIG. 5056



Install Corporate-Specific Virtual Kiosks

Control Panel for Installing Corporate-Specific Virtual Kiosks

Standard Demonstration Mode

Client Account: DISNEY

Client Account No: 7145001

User Name: John Smith

Text: R.135

777/1046

FIG. 507

Control Panel for Installing Corporate-Specific Virtual Kiosks



Install Corporate-Specific Virtual Kiosks

Standard Demonstration Mode

Select Corporate-Specific Virtual Kiosks

Client Account: DISNEY | Client Account No: 7145001 | User Name: John Smith

The following Corporate-Specific Virtual Kiosks are available for installation. Select the Corporate-Specific Virtual Kiosks you wish to install by checking the install checkbox. -- for everyone
If there are Corporate-Specific Virtual Kiosks available for more than one Vendor, then the Corporate-Specific Virtual Kiosks shall be sorted by Vendor name. Click 'A' to view Corporate-Specific Virtual Kiosks from Vendors beginning with the letter 'A', etc. -- for only consumers

Click Next to install the selected Corporate-Specific Virtual Kiosks. -- for everyone
Click Search to search for the Corporate-Specific Virtual Kiosks associated with a particular Vendor. -- for only consumers. Below the alphabet bar is also only for consumers. Below the Search button also shall only be visible for consumers.

A B C D E F G H I J K L M N O P Q R S T U V W X Y Z I

1 1 2 3 4 5 6 7 8 9 10 1

Vendor Name	P-S Virtual Kiosk Serial Number	P-S Virtual Kiosk Name	Launch Environment	Installation Language	Currently Installed	Install
Vendor Name 1	0900989098-88	Virtual Kiosk Name 1	Deployment Environment 1	Installation language	Currently Installed	<input type="checkbox"/>
Vendor Name 2	0900989098-88	Virtual Kiosk Name 2	Deployment Environment 2	Installation language	Currently Installed	<input type="checkbox"/>
Vendor Name 3	0900989098-88	Virtual Kiosk Name 3	Deployment Environment 3	Installation language	Currently Installed	<input type="checkbox"/>
Vendor Name 4	0900989098-88	Virtual Kiosk Name 4	Deployment Environment 4	Installation language	Currently Installed	<input type="checkbox"/>
Vendor Name 5	0900989098-88	Virtual Kiosk Name 5	Deployment Environment 5	Installation language	Currently Installed	<input type="checkbox"/>

Back 1 2 3 4 5 Next >>>

FIG. 5041

Search Next

778/1046



Install Corporate-Specific Virtual Kiosks

Control Panel for Installing Corporate Specific Virtual Kiosks

Standard Demonstration Mode

SEARCH FOR VENDORS

Client Account: DISNEY

Client Account No: 7145001

User Name: John Smith

Search for the Vendor whose Corporate-Specific Virtual Kiosks you wish to install. Click Next to initiate the Vendor search.

Search for:

Search by: Vendor Name



179/1046

Back

Next

FIG 504Z



Install Corporate-Specific Virtual Kiosks

Control Panel for Installing Corporate-Specific Virtual Kiosks

Standard Demonstration Mode

SEARCH VENDORS

Client Account: DISNEY | Client Account No: 7145001 | User Name: John Smith

The following Vendors matched your search criteria and have Corporate-Specific Virtual Kiosks available to install. Click on the Vendor Name to view Corporate-Specific Virtual Kiosks for the selected Vendor.

Vendor Name	Vendor Identification Number (MIN)	No. of Virtual Kiosks
<u>Vendor Name 1</u>	MIN 1	Virtual Kiosk No 1
<u>Vendor Name 2</u>	MIN 2	Virtual Kiosk No 2
<u>Vendor Name 3</u>	MIN 3	Virtual Kiosk No 3
<u>Vendor Name 4</u>	MIN 4	Virtual Kiosk No 4
<u>Vendor Name 5</u>	MIN 5	Virtual Kiosk No 5

100/1046

FIG. 50U3
http://www.brandkeysystems.com/bk_deliver/m_install_corporate-3.html

file:///www/brandkey/bk_deliver/TFP9waljesf6.htm

5/12/2008

Back



Control Panel for Installing Corporate Specific Virtual Kiosks

Install Corporate-Specific Virtual Kiosks
Corporate-Specific Virtual Kiosks - Brandkey Deliver Subsystem - Download Virtual Kiosk Tool

Standard Demonstration Mode

Update Installation Location Information

Client Account: DISNEY | Client Account No: 7145001 | User Name: John Smith

The following information is required before you can download the installation files for the Corporate-Specific Virtual Kiosks. This information is used by Vendors and their agents to better customize the Corporate-Specific Virtual Kiosks for your needs.

User Name:

Installation Domain: (e.g. www.virtualkiosklaunchsite.com)

Physical Location:

City:

State: -- Select One --

Zip/Postal Code:

Country: United States

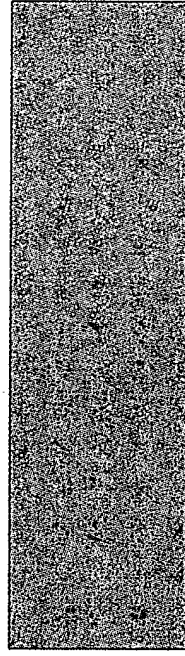

Purpose of Installation:

702/1046

Back Next

FIG.5045



Install Corporate-Specific Virtual Kiosks

Control Panel for Installing Corporate-Specific Virtual Kiosks

Standard Demonstration Mode

Client Account: DISNEY

Client Account No: 7145001

User Name: John Smith

The setup files for the selected Corporate-Specific Virtual Kiosk(s) have been prepared. You have selected corporate-specific Virtual Kiosk(s) that are Launchable from the following environments.

Launch Environment	Selected	Download Tags
HTML-Embedded Default Logo	<input checked="" type="checkbox"/>	Download Tags
HTML-Embedded Document	<input checked="" type="checkbox"/>	Download Tags
HTML-Encoded Image	<input checked="" type="checkbox"/>	Download Tags
HTML-Encoded Desktop Icon	<input checked="" type="checkbox"/>	Download Tags

703/1046

FIG. 5046

704/1046

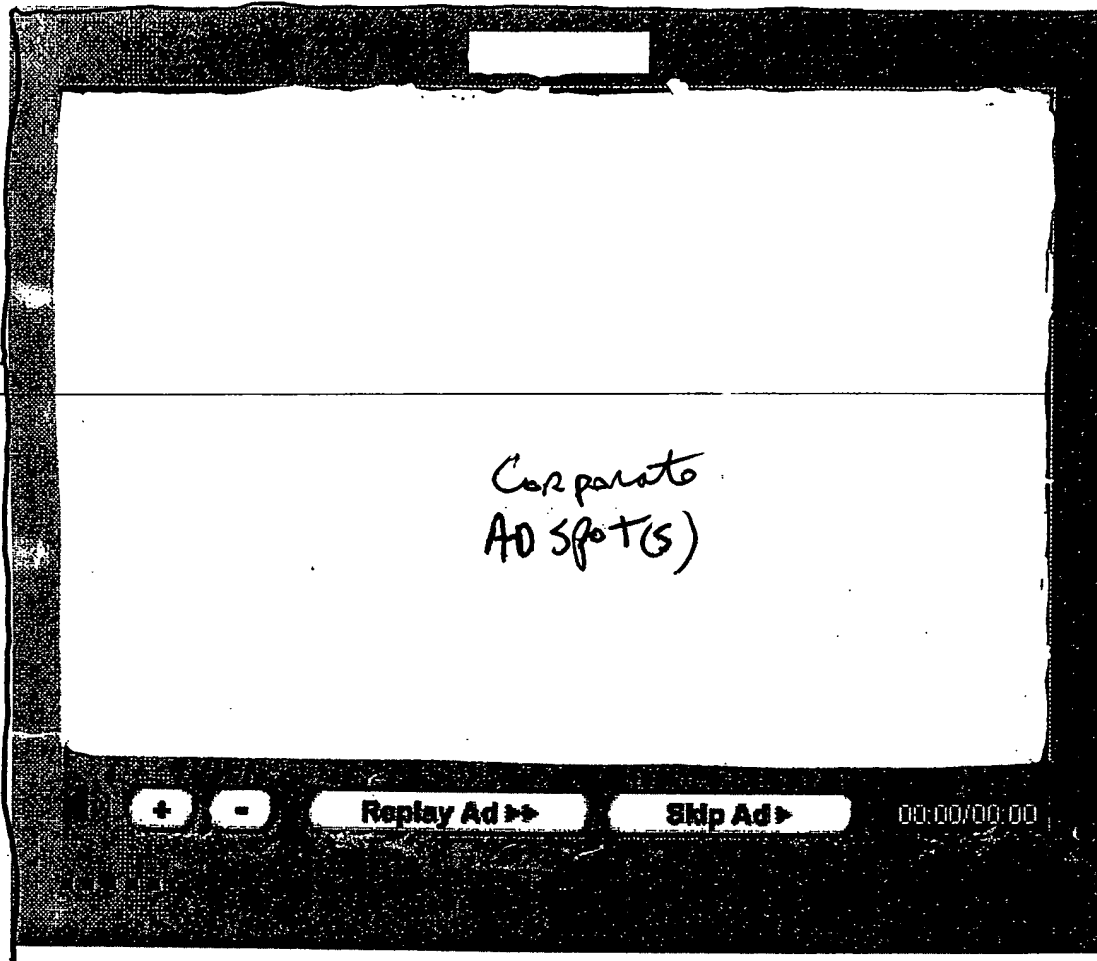

FIG. 50 VI

705/1046

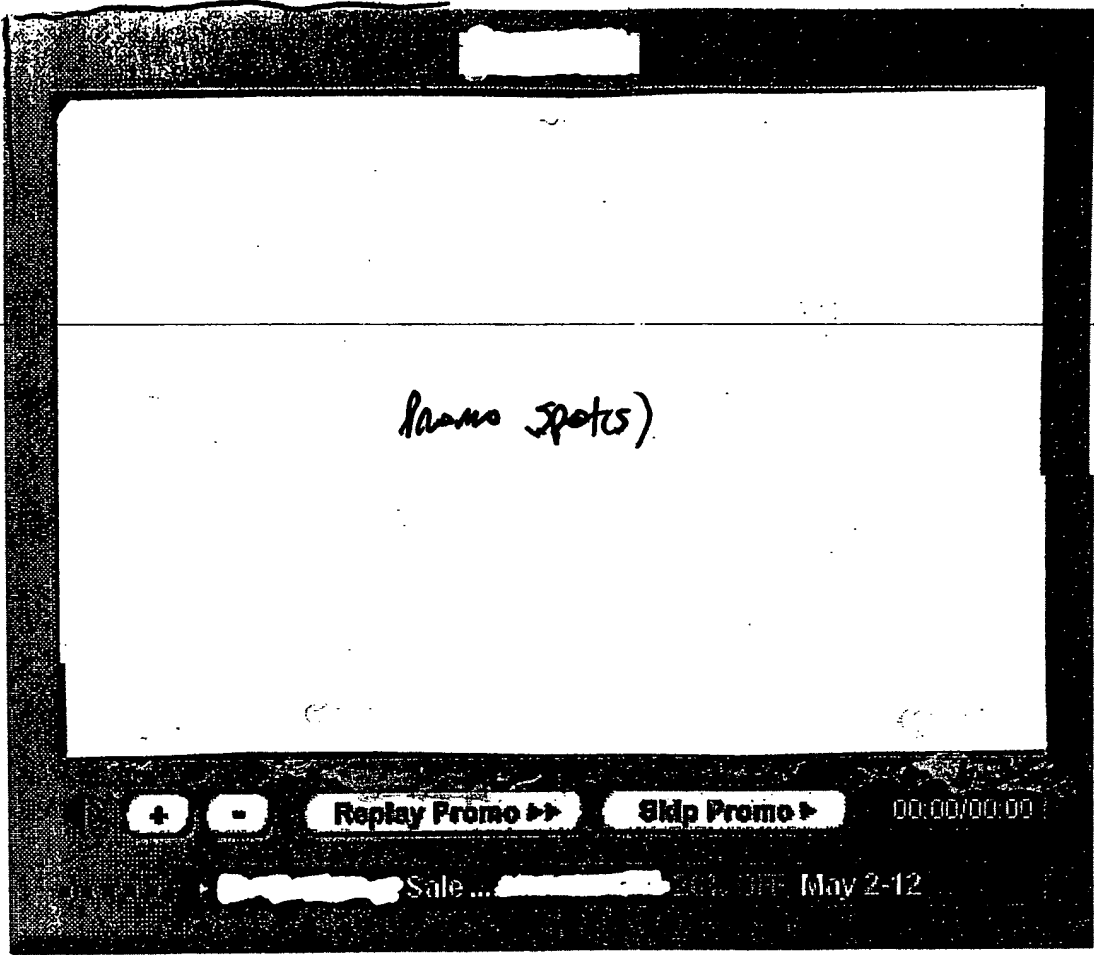

FIG. 50 V2

7806/1046

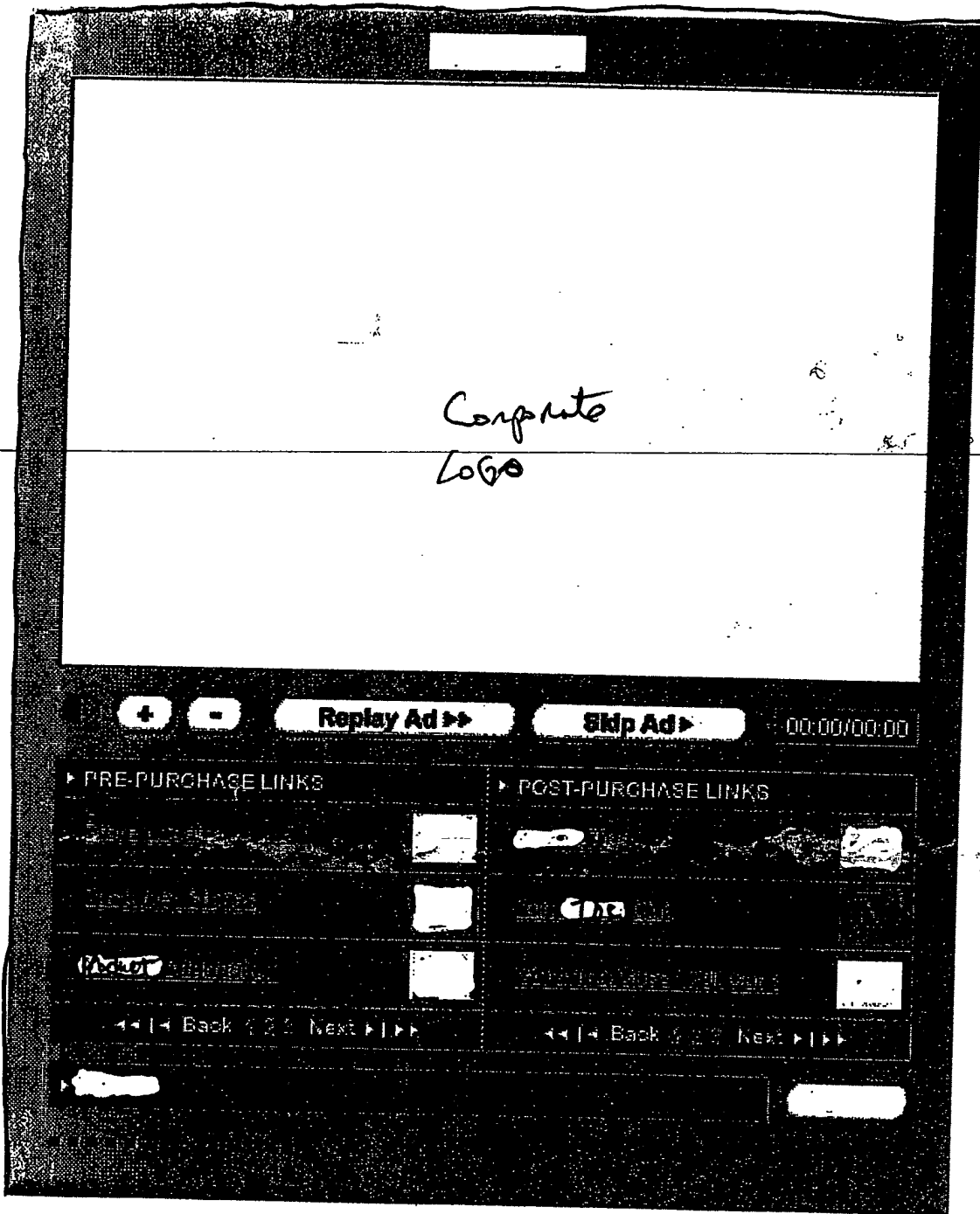

FIG. 50 V3

704/1046

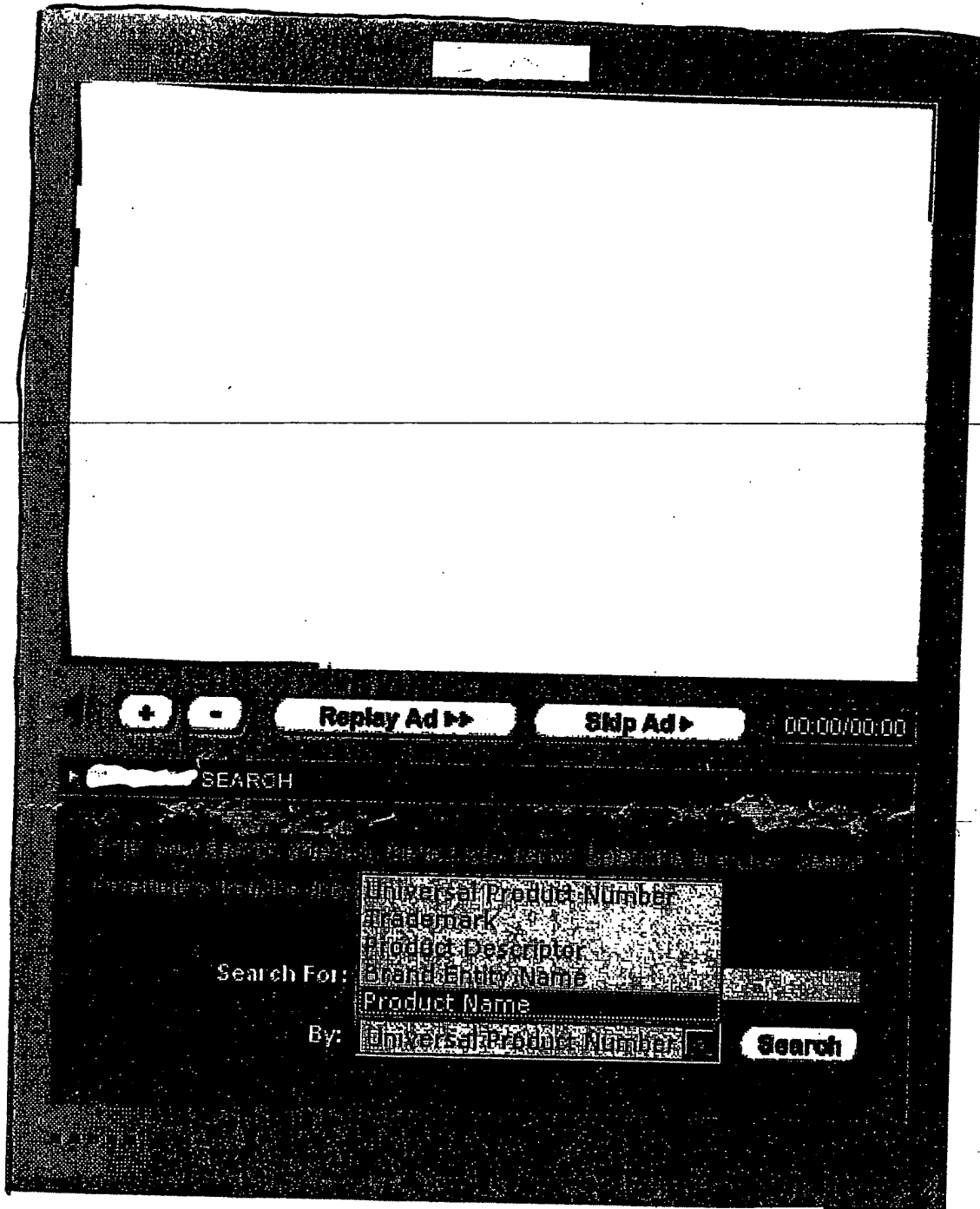

FIG. 50 V4

708/1046

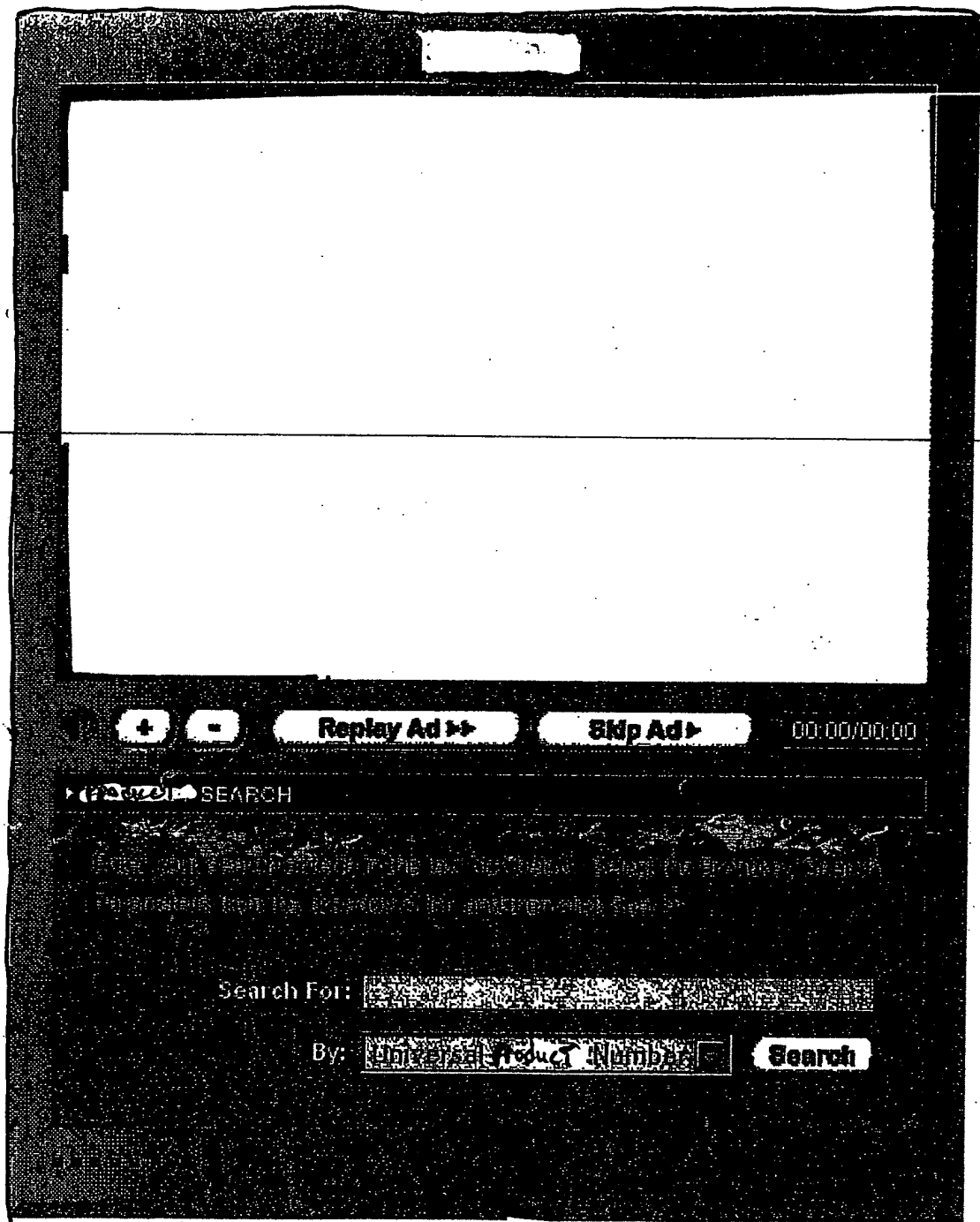

FIG. 50 V5

709/104b

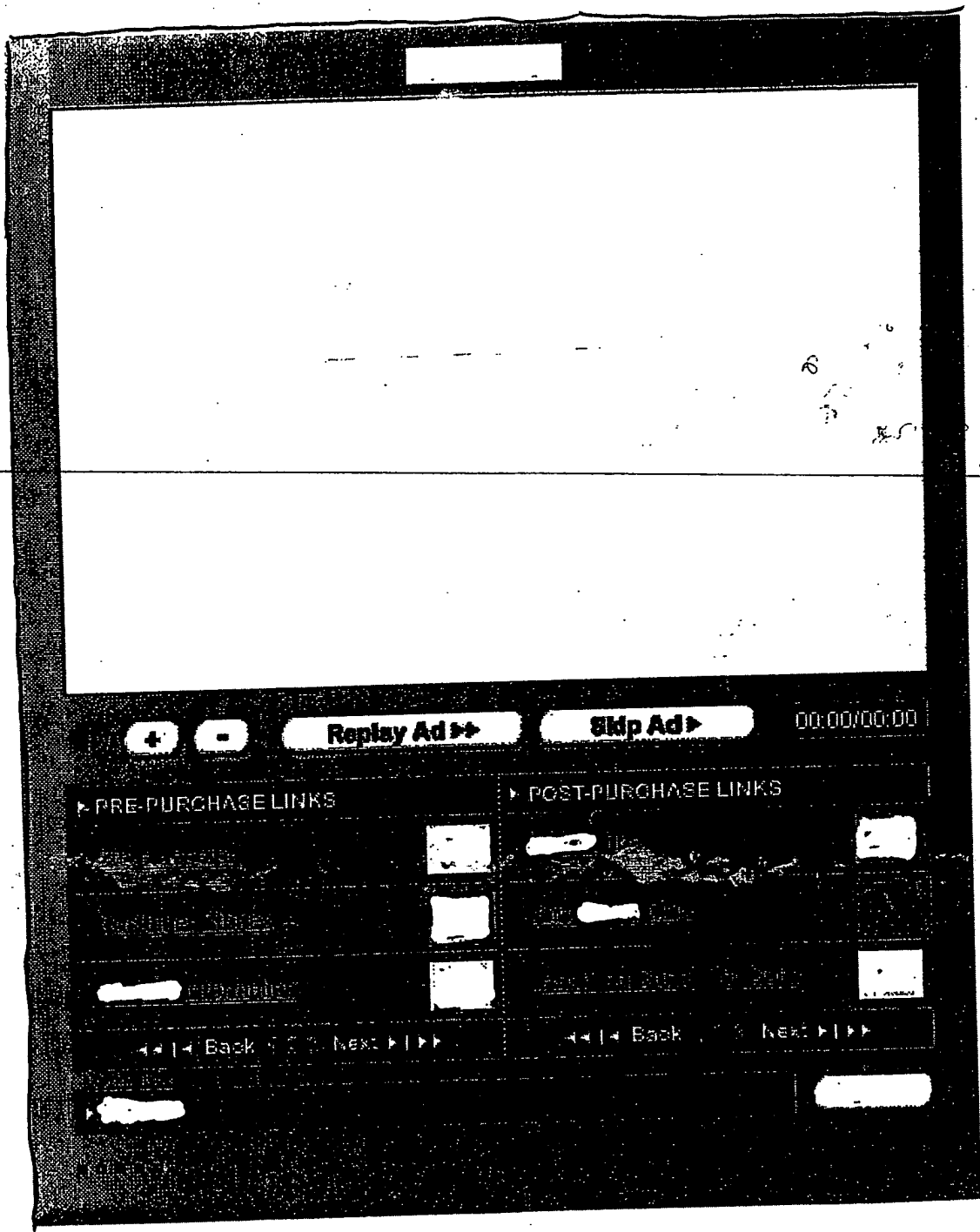

FIG. 50 V6

7901046



Tutorials

Brandkey Advertise

Advertise

Branded Products and Services

Advertise branded products and services by building, running and managing Advertising Campaigns on Multi-Mode Virtual Kiosks delivered to Consumers.



FIG. 51A

791 / 1046



- ▶ Brand Managers
- ▶ Advertising Agents
- ▶ Promotional Agents
- ▶ Full Service Agents
- ▶ Marketing Consultants
- ▶ Brand Consultants
- ▶ Trademark Attorneys

Brandkey Advertise Subsystem Benefits - Standard Demonstration Mode

The Brandkey Advertise™ Subsystem offers brand managers and advertising agents a simple and convenient way of creating, executing and managing advertising campaigns designed to run on networks of multi-mode Virtual Kiosks deployed at Internet-based consumer touchpoints. This Brandkey™ Subsystem enables advertisers and their agents to generate Virtual Kiosk Advertising Directories specifying on which deployed virtual kiosks the advertiser and agents are permitted to run advertising campaigns while preserving the rights and obligations of the users of the Brandkey Systems™ Network.

FIG. 51B1

792/1046



Home | About Us | Investors | Careers | Site Map | Contact Us | Help | Login

Brandkey systems | Brandkey create | Brandkey deliver | Brandkey advertise | Brandkey promote

► Launch Control Panel for Managing Advertising Campaigns

Virtual Kiosk Advertising Campaign Management Suite - Standard Demonstration Mode

Client Account: DISNEY | Client Account No: 7145001

User Name: John Smith

Text: D.156

FIG 51 C1



Directory Management

Campaign Management

Ad-Spot Management

Control Panel for Managing Advertising Campaigns

Standard Demonstration Mode

Client Account: DISNEY

Client Account No: 7145001

User Name: John Smith

Text Here.

793/1016

FIG. 51C2



Directory Management

Campaign Management

Ad-Spot Management

Control Panel for Managing Advertising Campaigns

Standard Demonstration Mode

Directory Management

Client Account: DISNEY

Client Account No: 7145001

User Name: John Smith

Text Here.

794/1046

FIG. 5/D1



Directory Management

Campaign Management

Ad-Spot Management

Control Panel for Managing Advertising Campaigns

Standard Demonstration Mode

SELECT THE DIRECTORY TYPE

Client Account: DISNEY

Client Account No: 7145001

User Name: John Smith

Select the Type of Advertising Directory you wish to Generate.

- General Advertising Directory
- Brand-Specific Advertising Directory

195/1046

Next Next

FIG. 51 DZ



Directory Management

Campaign Management

Ad-Spot Management

Control Panel for Managing Advertising Campaigns

Standard Demonstration Mode

Select Virtual Kiosk Types

Client Account: DISNEY

Client Account No: 7145001

User Name: John Smith

Specify the Types of Virtual Kiosks to be listed in the General Virtual Kiosk Advertising Directory.

- Product-Specific (P-S) Virtual Kiosks
- Service-Specific (S-S) Virtual Kiosks
- Vendor-Specific (V-S) Virtual Kiosks
- Service-Provider Specific (S-P-S) Virtual Kiosks
- Retailer-Specific (R-S) Virtual Kiosks (having registered Vendor's shelf rights)
- Industry-Specific (I-S) Virtual Kiosks (having registered Vendor's shelf rights)
- Corporate-Specific (C-S) Virtual Kiosks

FIG. 51D3

Back Next

<http://www.brandkey.com/bk-advertise/m-advertising-directory-general-1.html>

<file:///www.brandkey/bk-advertise/FMPc5a0qesis4.htm>

796/1046



Control Panel for Managing Advertising Campaigns

Directory Management Campaign Management Ad-Spot Management

Standard Demonstration Mode

Name: General Virtual Kiosk Advertising Directory

Client Account: DISNEY Client Account No: 7145001 User Name: John Smith

Please assign a name to the General Virtual Kiosk Advertising Directory you wish to Generate.

Name Directory:

797/1046

Back Next

FIG. 51.D4



Control Panel for Managing Advertising Campaigns

Directory Management

Campaign Management

Ad-Spec Management

Standard Demonstration Mode

[Generate the General Virtual Kiosk Advertising Directory](#)

Client Account: DISNEY

Client Account No: 7145001

User Name: John Smith

Please click the Generate button to create the General Virtual Kiosk Advertising Directory.

Back Generate Directory

740/1046

FIG. 51D5



Control Panel for Managing Advertising Campaigns

Directory Management

Campaign Management

Ad-Spots Management

Standard Demonstration Mode

Client Account: DISNEY | Client Account No: 7145001 | User Name: John Smith

General Virtual Kiosk Advertising Directory

Virtual Kiosk Serial Number	Virtual Kiosk Type Code	Virtual Kiosk Sponsor	Virtual Kiosk Display Mode	Virtual Kiosk Installation Domain	Physical Location of Virtual Kiosk (if known or Applicable)	Virtual Kiosk User Activity Indices	Ad Spot Rate (\$/impression)
90009060	PS	Sponsor	Tri-Mode	http://www.nike.com	Cosco; Norwalk, CT	activity indices	\$/impression
90009061	MS	Sponsor	Dual-Mode	http://www.nike.com	Cosco; Norwalk, CT	activity indices	\$/impression
90009062	RS	Sponsor	Tri-Mode	http://www.nike.com	Cosco; Norwalk, CT	activity indices	\$/impression
90009063	PS	Sponsor	Tri-Mode	http://www.nike.com	Cosco; Norwalk, CT	activity indices	\$/impression
90009064	IS	Sponsor	Dual-Mode	http://www.nike.com	Cosco; Norwalk, CT	activity indices	\$/impression

◀◀ | ◀ Back 1 2 3 4 5 Next ▶▶

Download PDF

Download PDF copy of the General Virtual Kiosk Advertising Directory

FIG. 5106

799/1046



Control Panel for Managing Advertising Campaigns

Directory Management

Campaign Management

Ad Sub: Management

Standard Demonstration Mode

Client Account: DISNEY

Client Account No: 7145001

User Name: John Smith

Search for the Brand Entities associated with your Client Account, which you wish to include in this Brand-Specific Virtual Kiosk Advertising Directory. You may search by Trademark, Servicemark, Product Descriptor, or Brand Entity Name. Enter the Search Criteria in the textbox, select the Brand-Related Key from the dropdown menu, and then click the Search button to initiate the Brand Entity search.

Search for:

By: Trademark

900/1046

FIG. 51.D7

<http://www.brandkeysystems.com/bk-advertise/m-advertising-directory-brand-1.htm>

file://www.brandkeybk_advertise/IVP/d2q3sejzh.htm



Control Panel for Managing Advertising Campaigns

Directory Management

Campaign Management

Ad-Spot Management

Standard Demonstration Mode

SEARCH CRITERIA

Client Account: DISNEY Client Account No: 7145001 User Name: John Smith

Below are listed the Brand Entities that matched your Search Criteria. Please select the ones you wish to add to the Brand-Specific Virtual Kiosk Advertising Directory by checking the Add checkbox.

Brand Entity	Brand Entity Owner	Trademark / Service Mark	Product Descriptor / Service Descriptor	No. of Products / Services	Add
Here will go the brand entity	Here will go the brand owner	Here will go the trade mark	Here will go the product name	Here will go the No. of products	<input type="checkbox"/>
Here will go the brand entity	Here will go the brand owner	Here will go the trade mark	Here will go the product name	Here will go the No. of products	<input type="checkbox"/>
Here will go the brand entity	Here will go the brand owner	Here will go the trade mark	Here will go the product name	Here will go the No. of products	<input type="checkbox"/>
Here will go the brand entity	Here will go the brand owner	Here will go the trade mark	Here will go the product name	Here will go the No. of products	<input type="checkbox"/>
Here will go the brand entity	Here will go the brand owner	Here will go the trade mark	Here will go the product name	Here will go the No. of products	<input type="checkbox"/>

4 4 | 4 Back 1 2 3 4 5 Next | >>

Back Next

FIG 51D8

801/1046



Control Panel for Managing Advertising Campaigns

Directory Management

Campaign Management

Ad-Spot Management

Standard Demonstration Mode

Select Virtual Kiosk Type

Client Account: DISNEY

Client Account No: 7145001

User Name: John Smith

Specify the Types of Virtual Kiosks to be listed in the General-Type Virtual Kiosk Advertising Directory.

- Product-Specific (P-S) Virtual Kiosks
- Service-Specific (S-S) Virtual Kiosks
- Vendor-Specific (V-S) Virtual Kiosks
- Service-Provider Specific (S-P-S) Virtual Kiosks
- Retailer-Specific (R-S) Virtual Kiosks (having registered vendor's shelf rights)
- Industry-Specific (I-S) Virtual Kiosks (having registered vendor's shelf rights)
- Corporate-Specific (C-S) Virtual Kiosks (having registered vendor's shelf rights)

002/1046

Back Next

FIG. 51D9



Control Panel for Managing Advertising Campaigns

Directory Management | Campaign Management | Account Management

Standard Demonstration Mode

Name: The Brand-Specific Virtual Kiosk Advertising Directory

Client Account: DISNEY | Client Account No: 7145001 | User Name: John Smith

Please assign a name to the Brand-Specific Virtual Kiosk Advertising Directory you wish to Generate

Name Directory:

003/1046

Back Next

FIG. 51D10



Control Panel for Managing Advertising Campaigns

Directory Management | Campaign Management | Ad-Spec Management

Standard Demonstration Mode

Generating the Brand-Specific Virtual Kiosk Advertising Directory

Client Account: DISNEY | Client Account No: 7145001 | User Name: John Smith

Please click the Generate button to create the Brand-Specific Virtual Kiosk Advertising Directory.

Back | Generate Directory

FIG. 51D11

804/1046



Standard Demonstration Mode

Client Account: DISNEY Client Account No: 7145001 User Name: John Smith

Brand-Specific Virtual Kiosk Advertising Directory

Virtual Kiosk Serial Number	Virtual Kiosk Type Code	Virtual Kiosk Sponsor	Virtual Kiosk Display Mode	Virtual Kiosk Installation Domain	Physical Location of Virtual Kiosk (if known or Applicable)	Virtual Kiosk User Activity Indices	Ad Spot Rate (\$/Impression)
90009060	PS	Sponsor	Tri-Mode	http://www.nike.com	Cosco; Norwalk, CT	activity_indices	\$/impression
90009061	MS	Sponsor	Dual-Mode	http://www.nike.com	Cosco; Norwalk, CT	activity_indices	\$/impression
90009062	RS	Sponsor	Tri-Mode	http://www.nike.com	Cosco; Norwalk, CT	activity_indices	\$/impression
90009063	PS	Sponsor	Tri-Mode	http://www.nike.com	Cosco; Norwalk, CT	activity_indices	\$/impression
90009064	IS	Sponsor	Dual-Mode	http://www.nike.com	Cosco; Norwalk, CT	activity_indices	\$/impression

Back 1 2 3 4 5 Next

005/1046



Download PDF copy of the Brand-Specific Virtual Kiosk Advertising Directory

FIG.51.D12



Control Panel for Managing Advertising Campaigns

Directory Management Campaign Management Ad-Spot Management

Standard Demonstration Mode

General Advertising Directory/Adtype

Client Account: DISNEY Client Account No: 7145001 User Name: John Smith

Select the Type of Advertising Directory you wish to Modify.

- General Advertising Directory
- Brand-Specific Advertising Directory

800611046



FIG. 51D13



Control Panel for Managing Advertising Campaigns

Directory Management

Campaign Management

Ad-Spot Management

Standard Demonstration Mode

General Advertising Directory

Client Account: DISNEY Client Account No: 7145001 User Name: John Smith

Select the General Advertising Directory you wish to modify.

General Advertising Directory	Date Created
Advertising_Directory_1	01/20/2003
Advertising_Directory_2	02/04/2003
Advertising_Directory_3	03/25/2003
Advertising_Directory_4	04/01/2003
Advertising_Directory_5	05/14/2003

Back 1 2 3 4 5 Next

807/1046

FIG. 51D14

Back

http://www.brandkey.com/bk_advertise/m - advertising - directory - modify - m - general.html



Directory Management | Campaign Management | Ad-Spot Management

Standard Demonstration Mode

Virtual Kiosk Type

Client Account: DISNEY | Client Account No: 7145001 | User Name: John Smith

Specify the Types of Virtual Kiosks to be listed in the General Advertising Directory. The Virtual Kiosk Types you have previously chosen are checked by default. If you wish to add a Virtual Kiosk Type, then check its checkbox. If you wish to remove a Virtual Kiosk Type, then uncheck its checkbox.

- Product-Specific (P-S) Virtual Kiosks
- Service-Specific (S-S) Virtual Kiosks
- Vendor-Specific (V-S) Virtual Kiosks
- Service-Provider Specific (S-P-S) Virtual Kiosks
- Retailer-Specific (R-S) Virtual Kiosks (having registered Vendor's shelf rights)
- Industry-Specific (I-S) Virtual Kiosks (having registered Vendor's shelf rights)
- Corporate-Specific (C-S) Virtual Kiosks

Back Next

FIG. 5.1 D15

808/1046



Control Panel for Managing Advertising Campaigns

Directory Management Campaign Management Ad-Spot Management

Standard Demonstration Mode

Return to General Advertising Directory

Client Account: DISNEY Client Account No: 7145001 User Name: John Smith

You may change the Name assigned to this General Advertising Directory.

Directory Name: Advertising Directory 1

809/1046

Back Next

FIG. 51D16



Directory Management

General Advertising Database

Campaign Management

Ad-Spot Management

Control Panel for Managing Advertising Campaigns

Standard Demonstration Mode

Modify Advertising Directory

Client Account: DISNEY

Client Account No: 7145001

User Name: John Smith

Please click the Modify button to modify the selected General Advertising Directory.

810/1046

Back Modify Directory

FIG. 51: D17



Directory Management
Campaign Management
Ad Spot Management

Control Panel for Managing Advertising Campaigns

Standard Demonstration Mode

General Advertising Directory

Client Account: DISNEY | Client Account No: 7145001 | User Name: John Smith

General Virtual Kiosk Advertising Directory

Virtual Kiosk Serial Number	Virtual Kiosk Code	Virtual Kiosk Type	Virtual Kiosk Sponsor	Virtual Kiosk Display Mode	Virtual Kiosk Installation Domain	Physical Location of Virtual Kiosk (if known or applicable)	Virtual Kiosk User Activity Indices	Ad Spot Rate (\$/Impression)
90009060	PS		Sponsor	Tri-Mode	http://www.nike.com	Cosco; Norwalk, CT	activity_indices	\$/Impression
90009061	MS		Sponsor	Dual-Mode	http://www.nike.com	Cosco; Norwalk, CT	activity_indices	\$/Impression
90009062	RS		Sponsor	Tri-Mode	http://www.nike.com	Cosco; Norwalk, CT	activity_indices	\$/Impression
90009063	PS		Sponsor	Tri-Mode	http://www.nike.com	Cosco; Norwalk, CT	activity_indices	\$/Impression
90009064	IS		Sponsor	Dual-Mode	http://www.nike.com	Cosco; Norwalk, CT	activity_indices	\$/Impression

811/1046

4 | Back 1 2 3 4 5 Next >>

Download

Download PDF copy of the selected General Advertising Directory

FIG. 51-D18



Control Panel for Managing Advertising Campaigns

Directory Management | Campaign Management | Ad-Space Management

Standard Demonstration Mode

Select Brand-Specific Advertising Directory

Client Account: DISNEY | Client Account No: 7145001 | User Name: John Smith

Select the Brand-Specific Advertising Directory you wish to modify.

Brand-Specific Advertising Directory	Date Created
Advertising_Directory_1	01/20/2003
Advertising_Directory_2	02/04/2003
Advertising_Directory_3	03/25/2003
Advertising_Directory_4	04/01/2003
Advertising_Directory_5	05/14/2003

812/1046

Back 1 2 3 4 5 Next

FIG. 51D19



http://www.brandkey.com/bk_advertise/m_advertise-directory-m-brand-1.htm

file://www.brandkey.com/bk_advertise/IMP/IMP7fcskrrw.htm

5/12/2003



Standard Demonstration Mode

SELECT BRAND ENTITIES

Client Account: DISNEY | Client Account No: 7145001 | User Name: John Smith

You have selected the following Brand Entities for the Brand-Specific Advertising Directory. To remove a Brand Entity simply uncheck its selected checkbox. Click Next to specify the Virtual Kiosk types for the Brand-Specific Advertising Directory. Click Add Brands to select more Brand Entities to add to the Brand-Specific Advertising Directory.

Brand Entity	Brand Entity Owner	Trademark/Service mark	Product/Service Descriptor	No. of Product/Services	Selected
Brand Entity 1	Brand Entity Owner 1	Trademark 1	Product Descriptor 1	Product 1	<input checked="" type="checkbox"/>
Brand Entity 2	Brand Entity Owner 2	Trademark 2	Product Descriptor 2	Product 2	<input checked="" type="checkbox"/>
Brand Entity 3	Brand Entity Owner 3	Trademark 3	Product Descriptor 3	Product 3	<input checked="" type="checkbox"/>
Brand Entity 4	Brand Entity Owner 4	Trademark 4	Product Descriptor 4	Product 4	<input checked="" type="checkbox"/>
Brand Entity 5	Brand Entity Owner 5	Trademark 5	Product Descriptor 5	Product 5	<input checked="" type="checkbox"/>

813/1046

« Back 1 2 3 4 5 Next »

Back Add Brands Next

FIG. 51D20



Control Panel for Managing Advertising Campaigns

Directory Management Campaign Management Ad-Spot Management

Standard Demonstration Mode

SEARCH FOR BRAND ENTITIES

Client Account: DISNEY Client Account No: 7145001 User Name: John Smith

Search for the Brand Entities associated with your Client Account, which you wish to include in this Brand-Specific Virtual Kiosk Advertising Directory. You may search by Trademark, Service mark, Product Descriptor, or Brand Entity Name. Enter the Search Criteria in the textbox, select the Brand-Related Key from the dropdown menu, and then click the Search button to initiate the Brand Entity search.

Search for: [text box]

By: Trademark

814/1046



FIG. 51021



[Directory Management](#) |
 [Campaign Management](#) |
 [Ad-Spot Management](#)

Standard Demonstration Mode

Selected Brand Entities

Client Account: DISNEY |
 Client Account No: 7145001 |
 User Name: John Smith

Below are listed the Brand Entities that matched your Search Criteria. Please select the ones you wish to add to the Brand-Specific Virtual Kiosk Advertising Directory by checking the Add checkbox.

Brand Entity	Brand Entity Owner	Trademark / Service Mark	Product Descriptor / Service Descriptor	No. of Products / Services	Add
Here will go the brand entity	Here will go the brand entity owner	Here will go the trade mark	Here will go the product name	Here will go the No. of products	<input type="checkbox"/>
Here will go the brand entity	Here will go the brand entity owner	Here will go the trade mark	Here will go the product name	Here will go the No. of products	<input type="checkbox"/>
Here will go the brand entity	Here will go the brand entity owner	Here will go the trade mark	Here will go the product name	Here will go the No. of products	<input type="checkbox"/>
Here will go the brand entity	Here will go the brand entity owner	Here will go the trade mark	Here will go the product name	Here will go the No. of products	<input type="checkbox"/>
Here will go the brand entity	Here will go the brand entity owner	Here will go the trade mark	Here will go the product name	Here will go the No. of products	<input type="checkbox"/>

815/1046

◀◀ | 4 Back | 1 2 3 4 5 | Next ▶▶

|

FIG. 51D22



Control Panel for Managing Advertising Campaigns

Directory Management

Campaign Management

Ad-Spot Management

Standard Demonstration Mode

SELECT VIRTUAL KIOSK TYPE

Client Account: DISNEY

Client Account No: 7145001

User Name: John Smith

Specify the Types of Virtual Kiosks to be listed in the Brand-Specific Virtual Kiosk Advertising Directory.

- Product-Specific (P-S) Virtual Kiosks
- Service-Specific (S-S) Virtual Kiosks
- Vendor-Specific (V-S) Virtual Kiosks
- Service-Provider Specific (S-P-S) Virtual Kiosks
- Retailer-Specific (R-S) Virtual Kiosks (having registered vendor's shelf rights)
- Industry-Specific (I-S) Virtual Kiosks (having registered vendor's shelf rights)
- Corporate-Specific (I-S) Virtual Kiosks (having registered vendor's shelf rights)

8/6/1046

Back Next

FIG. 51.D23



Control Panel for Managing Advertising Campaigns

Directory Management

Campaign Management

Ad-Spot Management

Standard Demonstration Mode

NEW! Brand-Specific Advertising Directory

Client Account: DISNEY

Client Account No: 7145001

User Name: John Smith

You may change the Name assigned to this Brand-Specific Advertising Directory.

Directory Name:

817/1046

Back Next

FIG. 51D24



Control Panel for Managing Advertising Campaigns

Directory Management | Campaign Management | Ad-Spot Management

Standard Demonstration Mode

Generate the Brand-Specific Virtual Kiosk Advertising Directory

Client Account: DISNEY | Client Account No: 7145001 | User Name: John Smith

Please click the Modify button to modify the Brand-Specific Virtual Kiosk Advertising Directory.

810/1040

Back Modify Directory

FIG. 51D25



Directory Management
Campaign Management
Ad-Space Management
Virtual Kiosk Advertising Directory

Control Panel for Managing Advertising Campaigns

Standard Demonstration Mode

Brand-Specific Virtual Kiosk Advertising Directory

Client Account: DISNEY | Client Account No: 7145001 | User Name: John Smith

Brand-Specific Virtual Kiosk Advertising Directory

Virtual Kiosk Serial Number	Virtual Kiosk Type Code	Virtual Kiosk Sponsor	Virtual Kiosk Display Mode	Virtual Kiosk Installation Domain	Physical Location of Virtual Kiosk (if known or Applicable)	Virtual Kiosk User Activity Indices	Ad Spot Rate (\$/Impression)
90009060	PS	Sponsor	Tri-Mode	http://www.nike.com	Cosco; Norwalk, CT	activity_indices	\$/Impression
90009061	MS	Sponsor	Dual-Mode	http://www.nike.com	Cosco; Norwalk, CT	activity_indices	\$/Impression
90009062	RS	Sponsor	Tri-Mode	http://www.nike.com	Cosco; Norwalk, CT	activity_indices	\$/Impression
90009063	PS	Sponsor	Tri-Mode	http://www.nike.com	Cosco; Norwalk, CT	activity_indices	\$/Impression
90009064	IS	Sponsor	Dual-Mode	http://www.nike.com	Cosco; Norwalk, CT	activity_indices	\$/Impression

4 | Back 1 2 3 4 5 | Next

819/1046

Download PDF copy of the Brand-Specific Virtual Kiosk Advertising Directory



FIG. 54D26



Control Panel for Managing Advertising Campaigns

Directory Management Campaign Management Ad-Soc: Management

Standard Demonstration Mode

Campaign Management

Client Account: DISNEY

Client Account No: 7145001

User Name: John Smith

Text Here.

820/1046

FIG. 51E1



Control Panel for Managing Advertising Campaigns

Directory Management | Campaign Management | Ad-Spot Management

Standard Demonstration Mode

Virtual Kiosk Advertising Campaign Registration

Client Account: DISNEY | Client Account No: 7145001 | User Name: John Smith

Please enter the information below in order to Register the new Virtual Kiosk Advertising Campaign.

Name of Virtual Kiosk Advertising Campaign:

Virtual Kiosk Advertising Campaign Registration Number:

Campaign Start Date:

Campaign End Date:

821/1046

Next

FIG. 51E2



Control Panel for Managing Advertising Campaigns

Directory Management | Campaign Management | Ad-Spot Management

Standard Demonstration Mode

Select the Virtual Kiosk Advertising Directory Type

Client Account: DISNEY | Client Account No: 7145001 | User Name: John Smith

Please select which Type of Virtual Kiosk Advertising Directory you wish to use to build the new Virtual Kiosk Advertising Campaign.

- General Virtual Kiosk Advertising Directory
- Brand-Specific Virtual Kiosk Advertising Directory

022/1046

Back Next

FIG. 51 E3



Control Panel for Managing Advertising Campaigns

Directory Management | Campaign Management | Ad-Spot Management

Standard Demonstration Mode

Select Virtual Kiosk Advertising Directory

Client Account: DISNEY | Client Account No: 7145001 | User Name: John Smith

Please select the General Virtual Kiosk Advertising Directory you wish to use to build the new Virtual Kiosk Advertising Campaign.

General Virtual Kiosk Directory Name	Date Created
Irek@Cycles.2002	09/06/02
Jaz@Discs.2002	01/30/02
Gatorade_USA.2002	06/10/02
Irek@Cycles.2002	11/03/02
Jaz@Discs.2002	09/06/02

◀ Back 1 2 3 4 5 Next ▶▶

Please select the Brand-Specific Virtual Kiosk Advertising Directory you wish to use to build the new Virtual Kiosk Advertising Campaign.

Brand-Specific Virtual Kiosk Directory Name	Date Created
Irek@Cycles.2002	09/06/02
Jaz@Discs.2002	01/30/02
Gatorade_USA.2002	06/10/02
Irek@Cycles.2002	11/03/02
Jaz@Discs.2002	06/10/02

◀ Back 1 2 3 4 5 Next ▶▶

823/1046

FIG. 5.1E4

Back button inserted



Control Panel for Managing Advertising Campaigns

Directory Management

Campaign Management

Ad-Spot Management

Standard Demonstration Mode

Virtual Kiosks

Client Account: DISNEY | Client Account No: 7145001 | User Name: John Smith

Please select the Virtual Kiosks you wish to add to the Virtual Kiosk Advertising Campaign, by checking their Add to Campaign checkboxes. Click the Register button to Register the new Virtual Kiosk Advertising Campaign.

Virtual Kiosk Name	Virtual Kiosk Serial Number	Virtual Kiosk Code	Virtual Kiosk Type	Installation Domain	Physical Location (if applicable)	Add to Campaign
Trek® Cycles 2002	090987-098	Type goes here	Type goes here	http://www.trek.com/cycles.html	Norwalk, CT	<input type="checkbox"/>
Jaz® Discs 2002	090987-099	Type goes here	Type goes here	http://www.jaz.com/discs/jaz.html	Greenwich, CT	<input type="checkbox"/>
Jaz® Discs 2002	090987-099	Type goes here	Type goes here	http://www.jaz.com/discs/jaz.html	Miami, FL	<input type="checkbox"/>
Trek® Cycles 2002	090987-098	Type goes here	Type goes here	http://www.gatorade.com	Miami, FL	<input type="checkbox"/>
Jaz® Discs 2002	090987-099	Type goes here	Type goes here	http://www.nike.com/sneakers/pump-air.html	Norwalk, CT	<input type="checkbox"/>

◀ Back 1 2 3 4 5 Next ▶▶

Back Register Campaign

FIG. 51E5

824/1046



Control Panel for Managing Advertising Campaigns

Directory Management | Campaign Management | Ad-Space Management

Standard Demonstration Mode

Select Virtual Kiosk Advertising Campaign

Client Account: DISNEY | Client Account No: 7145001 | User Name: John Smith

Select the Virtual Kiosk Advertising Campaign you wish to Modify by clicking on its Name.

Advertising Campaign Name	Date of Advertising Campaign Registration	Advertising Campaign Registration Number	Advertising Campaign Status
Virtual_Kiosk_Ad	02-03-02	Virtual Kiosk Number	Running
Virtual_Kiosk_Ad	02-03-02	Virtual Kiosk Number	Running
Virtual_Kiosk_Ad	02-03-02	Virtual Kiosk Number	Expired
Virtual_Kiosk_Ad	02-03-02	Virtual Kiosk Number	Stopped
Virtual_Kiosk_Ad	02-03-02	Virtual Kiosk Number	Stopped

1 2 3 4 5 Back Next

825/1046

FIG. 51E6



Control Panel for Managing Advertising Campaigns

Directory Management Campaign Management

Ad-Spot Management

Standard Demonstration Mode

Client Account: DISNEY Client Account No: 7145001 User Name: John Smith

You may Modify the Virtual Kiosk Advertising Campaign by Adding or Removing Virtual Kiosks from the Campaign.

Master Data Record for Virtual Kiosk Advertising Campaign

Name of Advertising Campaign: Trek@ Cycles 2002 Date of Advertising Campaign Registration: 02-03-02 Advertising Campaign Registration Number: 09890-0989

Virtual Kiosk Added to Campaign	Virtual Kiosk Number	Virtual Kiosk Type Code	Virtual Kiosk Display Mode	Virtual Kiosk Installation Domain	Physical Location of Virtual Kiosk (if Applicable)	Virtual Kiosk User Activity Indices	Ad Spot Rate (\$/Impression)	Ad Spot Order Placed on Virtual Kiosks
<input checked="" type="checkbox"/>	90009060	PS	Codes	http://www.nike.com	Cosco; Norwalk, CT	activity Indices	\$/Impression	ASO#26
<input type="checkbox"/>	90009061	VS	Codes	http://www.nike.com	Cosco; Norwalk, CT	activity Indices	\$/Impression	ASO#29, ASO#32
<input type="checkbox"/>	90009062	RS	Codes	http://www.nike.com	Cosco; Norwalk, CT	activity Indices	\$/Impression	ASO#26
<input type="checkbox"/>	90009063	PS	Codes	http://www.nike.com	Cosco; Norwalk, CT	activity Indices	\$/Impression	ASO#29, ASO#32
<input type="checkbox"/>	90009064	IS	Codes	http://www.nike.com	Cosco; Norwalk, CT	activity Indices	\$/Impression	ASO#26

026/1040

Back 1 2 3 4 5 Next

FIG. 51E7



Control Panel for Managing Advertising Campaigns

Ad-Space Management

Campaign Management

Standard Demonstration Mode

Run Virtual Kiosk Advertising Campaigns

Client Account: DISNEY | Client Account No: 7145001 | User Name: John Smith

Select the Virtual Kiosk Advertising Campaigns you wish to Run by checking their Run checkboxes and then clicking the Run Advertising Campaign button.

- Virtual Kiosk Advertising Campaign Run
- Virtual Kiosk Advertising Campaign 1
- Virtual Kiosk Advertising Campaign 2
- Virtual Kiosk Advertising Campaign 3
- Virtual Kiosk Advertising Campaign 4

Run Campaign

827/1046

Stop Virtual Kiosk Advertising Campaigns

Select the Virtual Kiosk Advertising Campaigns you wish to Stop by checking their Stop checkboxes and then clicking the Stop Advertising Campaign button.

- Virtual Kiosk Advertising Campaign Stop
- Virtual Kiosk Advertising Campaign 1
- Virtual Kiosk Advertising Campaign 2

FIG. 51E8

Brandkey Advertise Subsystem

Virtual Kiosk Advertising Campaign 3

Virtual Kiosk Advertising Campaign 4



Stop Campaign

020/1046

FIG. 51E9



Control Panel for Managing Advertising Campaigns

Directory Management | Campaign Management | Ad-Spot Management

Standard Demonstration Mode

Select Virtual Kiosk Advertising Campaign

Client Account: DISNEY | Client Account No: 7145001 | User Name: John Smith

Select the Virtual Kiosk Advertising Campaign you wish to Monitor by clicking on its Name.

Advertising Campaign Name	Date of Advertising Campaign Registration	Advertising Campaign Registration Number	Advertising Campaign Status
Virtual Kiosk Ad	02-03-02	Campaign Registration Number	Running
Virtual Kiosk Ad	02-03-02	Campaign Registration Number	Running
Virtual Kiosk Ad	02-03-02	Campaign Registration Number	Expired
Virtual Kiosk Ad	02-03-02	Campaign Registration Number	Stopped
Virtual Kiosk Ad	02-03-02	Campaign Registration Number	Stopped

<< | Back 1 2 3 4 5 Next | >>

029/1046

FIG 51 E10



Control Panel for Managing Advertising Campaigns

Directory Management Campaign Management Ad-Spot Management

Standard Demonstration Mode

Client Account: DISNEY Client Account No: 7145001 User Name: John Smith

You may review the statistics compiled for the selected Virtual Kiosk Advertising Campaign.

Advertising Campaign Name: Ad campaign name
 Advertising Campaign Registration Number: Registration Number
 Advertising Campaign Registration's Date: 06/09/02
 Advertising Campaign Status: Running
 Total Number of Advertisements placed on Campaign's Virtual Kiosks: 5221
 Total Number of Advertisements Run on Campaign's Virtual Kiosks: 3521
 Total Number of Advertisement-Spot Interruptions on Retail-Specific Virtual Kiosks: 275
 Total Number of Brand Information Networks Accessed by Consumers Responsive to Ad-Spots Run on Virtual Kiosks: 679

890/1040

FIG. 51E11



Control Panel for Managing Advertising Campaigns

Directory Management
Ad-Spot Management
Campaign Management

Ad-Spot Management

Standard Demonstration Mode

Ad-Spot Management

Client Account: DISNEY

Client Account No: 7145001

User Name: John Smith

Text Here.

831/1046

FIG. 51F1



Control Panel for Managing Advertising Campaigns

Directory Management

Campaign Management

Ad-Spot Management

Standard Demonstration Mode

Select Virtual Kiosk Advertising Campaign

Client Account: DISNEY

Client Account No: 7145001

User Name: John Smith

Select the Registered Virtual Kiosk Advertising Campaign on which you wish to place Advertising-Spot Orders.

Name of Virtual Kiosk Advertising Campaign	Registration Number	Registration Date
Irek@Cycles 2002	09890-0989	02-03-02
Jaz@Discs 2002	09890-0995	02-03-02
Gatorade USA 2002	09890-1001	02-03-02
Just Do It!	09890-1025	02-03-02
Irek@Cycles 2002	09890-0989	02-03-02

Back 1 2 3 4 5 Next

832/1040

FIG. 50F2



Standard Demonstration Mode

Client Account: DISNEY

Client Account No: 7145001

User Name: John Smith

Select the Advertisement(s) which you wish to run in the selected Virtual Kiosk Advertising Campaign by checking its Add to Campaign checkbox. You may Preview any Advertisement by clicking on its URL in the list below.

URL of Advertisement	Title	Creator / Author	Owner	Add to Campaign
http://www.trek.com/cycles.html	Trek® Cycles 2002	Trek creator	Trek, Inc.	<input type="checkbox"/>
http://www.jaz.com/discs/jaz.html	Jaz® Discs 2002	lomega Creator	lomega	<input type="checkbox"/>
http://www.trek.com/cycles.html	Gatorade USA 2002	Gatorade Creator	Gatorade	<input type="checkbox"/>
http://www.jaz.com/discs/jaz.html	Just Do It!	Nike Creator	Nike	<input type="checkbox"/>
http://www.trek.com/cycles.html	Trek® Cycles 2002	Trek creator	Trek, Inc.	<input type="checkbox"/>

4 | 4 Back 1 2 3 4 5 Next ▶▶▶

0330/1046



FIG. 51F3



Directory Management

Campaign Management

Ad-Spot Management

Control Panel for Managing Advertising Campaigns

Standard Demonstration Mode

Client Account: DISNEY

Client Account No: 7145001

User Name: John Smith

Configure selected advertisement(s) that is to run in the Registered Virtual Kiosk Advertising Campaign. Click the Select Virtual Kiosks button to select the Virtual Kiosks on which the Advertisement will run. Click the Set Date button to set the Start Date on which the Advertisement will begin to run. Click the Set Frequency button to set the maximum number of times the Advertisement may run per hour.

URL of Advertisement	Title	Virtual Kiosks	Start Date	Frequency
http://www.trek.com/cycles.html	Trek® Cycles 2002	Select Virtual Kiosks	09/20/02	10 X/hr
http://www.jaz.com/discs/jaz.html	Jaz® Discs 2002	Select Virtual Kiosks	10/30/02	5 X/hr
http://www.gatorade.com	Gatorade USA 2002	Select Virtual Kiosks	07/10/02	2 X/hr
http://www.nike.com/sneakers/pump-air.html	Just Do It!	Select Virtual Kiosks	01/02/02	10 X/hr
http://www.trek.com/cycles.html	Trek® Cycles 2002	Select Virtual Kiosks	09/20/02	5 X/hr

◀ | ◀ Back 1 2 3 4 5 Next ▶ | ▶▶

Back Next

FIG. 51F4

034/1046



Control Panel for Managing Advertising Campaigns

Directory Management | Campaign Management | Ad Spot Management

Standard Demonstration Mode

Client Account: DISNEY | Client Account No: 7145001 | User Name: John Smith

Select the Virtual Kiosks on which the Advertisement will run.

P-S	S-S	V-S	S-P-S	R-S	I-S	C-S	All
Virtual Kiosk Name	Virtual Kiosk Serial Number	Installation Domain	Physical Location (if applicable)	Activity Indices	Ad Spot Rate (\$/Impression)	Add Ad	
Virtual Kiosk Name 1	090987-098	http://www.installationdomain1.html	Location 1	activity_indices \$/Impression		<input type="checkbox"/>	
Virtual Kiosk Name 2	090987-099	http://www.installationdomain2.html	Location 2	activity_indices \$/Impression		<input type="checkbox"/>	
Virtual Kiosk Name 3	090987-098	http://www.installationdomain3.html	Location 3	activity_indices \$/Impression		<input type="checkbox"/>	
Virtual Kiosk Name 4	090987-099	http://www.installationdomain4.html	Location 4	activity_indices \$/Impression		<input type="checkbox"/>	
Virtual Kiosk Name 5	090987-098	http://www.installationdomain5.html	Location 5	activity_indices \$/Impression		<input type="checkbox"/>	

◀◀ Back 1 2 3 4 5 Next ▶▶

005/1046

Select All Select

FIG. 51F5



Control Panel for Managing Advertising Campaigns

Directory Management

Campaign Management

Ad-Spot Management

Standard Demonstration Mode

Client Account: DISNEY

Client Account No: 7145001

User Name: John Smith

Select the Virtual Kiosks on which the Advertisement will run.

Virtual Kiosk Name	Virtual Kiosk Serial Number	Installation Domain	Physical Location (if applicable)	Activity Indices	Ad Spot Rate (\$/Impression)	Add Ad
Virtual Kiosk Name 1	090987-098	http://www.installationdomain1.html	Location 1	activity_indices \$/impression	\$/impression	<input type="checkbox"/>
Virtual Kiosk Name 2	090987-099	http://www.installationdomain2.html	Location 2	activity_indices \$/impression	\$/impression	<input type="checkbox"/>
Virtual Kiosk Name 3	090987-098	http://www.installationdomain3.html	Location 3	activity_indices \$/impression	\$/impression	<input type="checkbox"/>
Virtual Kiosk Name 4	090987-099	http://www.installationdomain4.html	Location 4	activity_indices \$/impression	\$/impression	<input type="checkbox"/>
Virtual Kiosk Name 5	090987-098	http://www.installationdomain5.html	Location 5	activity_indices \$/impression	\$/impression	<input type="checkbox"/>

836/1046

Back 1 2 3 4 5 Next

Select All Set

FIG. 51 F6



Control Panel for Managing Advertising Campaigns

Directory Management | Campaign Management | Ad Spot Management

Standard Demonstration Mode

Client Account: DISNEY | Client Account No: 7145001 | User Name: John Smith

Select the Virtual Kiosks on which the Advertisement will run.

P-S	S-S	V-S	S-P-S	R-S	I-S	C-S	All
Virtual Kiosk Name	Virtual Kiosk Serial Number	Installation Domain	Physical Location (if applicable)	Activity Indices	Ad Spot Rate (\$/Impression)	Add Ad	
Virtual Kiosk Name 1	090987-098	http://www.installationdomain1.html	Location 1	activity_indices	\$/impression	<input type="checkbox"/>	
Virtual Kiosk Name 2	090987-099	http://www.installationdomain2.html	Location 2	activity_indices	\$/impression	<input type="checkbox"/>	
Virtual Kiosk Name 3	090987-098	http://www.installationdomain3.html	Location 3	activity_indices	\$/impression	<input type="checkbox"/>	
Virtual Kiosk Name 4	090987-099	http://www.installationdomain4.html	Location 4	activity_indices	\$/impression	<input type="checkbox"/>	
Virtual Kiosk Name 5	090987-098	http://www.installationdomain5.html	Location 5	activity_indices	\$/impression	<input type="checkbox"/>	

◀◀ Back 1 2 3 4 5 Next ▶▶

337/1046

Select All Set

FIG. 51 F7



Control Panel for Managing Advertising Campaigns

Directory Management | Campaign Management | Ad-Spot Management

Standard Demonstration Mode

Select Virtual Kiosks

Client Account: DISNEY | Client Account No: 7145001 | User Name: John Smith

Select the Virtual Kiosks on which the Advertisement will run.

P-S	S-S	V-S	S-P-S	R-S	I-S	C-S	All
Virtual Kiosk Name	Virtual Kiosk Serial Number	Installation Domain	Physical Location (if applicable)	Activity Indices	Ad Spot Rate (\$/Impression)	Add Ad	
Virtual Kiosk Name 1	090987-098	http://www.installationdomain1.html	Location 1	activity_indices	\$/impression	<input type="checkbox"/>	
Virtual Kiosk Name 2	090987-099	http://www.installationdomain2.html	Location 2	activity_indices	\$/impression	<input type="checkbox"/>	
Virtual Kiosk Name 3	090987-098	http://www.installationdomain3.html	Location 3	activity_indices	\$/impression	<input type="checkbox"/>	
Virtual Kiosk Name 4	090987-099	http://www.installationdomain4.html	Location 4	activity_indices	\$/impression	<input type="checkbox"/>	
Virtual Kiosk Name 5	090987-098	http://www.installationdomain5.html	Location 5	activity_indices	\$/impression	<input type="checkbox"/>	

◀◀ | ◀ Back 1 2 3 4 5 Next ▶▶

839/1046

Select All

FIG. 51 F8



Control Panel for Managing Advertising Campaigns

Directory Management | Campaign Management | Ad Spot Management

Standard Demonstration Mode

Client Account: DISNEY | Client Account No: 7145001 | User Name: John Smith

Select the Virtual Kiosks on which the Advertisement will run.

P-S	S-S	V-S	S-P-S	R-S	I-S	C-S	A/I
Virtual Kiosk Name	Virtual Kiosk Serial Number	Installation Domain	Physical Location (if applicable)	Activity Indices	Ad Spot Rate (\$/impression)	Add Ad	
Virtual Kiosk Name 1	090987-098	http://www.installationdomain1.html	Location 1	activity_indices	\$/impression	<input type="checkbox"/>	
Virtual Kiosk Name 2	090987-099	http://www.installationdomain2.html	Location 2	activity_indices	\$/impression	<input type="checkbox"/>	
Virtual Kiosk Name 3	090987-098	http://www.installationdomain3.html	Location 3	activity_indices	\$/impression	<input type="checkbox"/>	
Virtual Kiosk Name 4	090987-099	http://www.installationdomain4.html	Location 4	activity_indices	\$/impression	<input type="checkbox"/>	
Virtual Kiosk Name 5	090987-098	http://www.installationdomain5.html	Location 5	activity_indices	\$/impression	<input type="checkbox"/>	

839/1046

◀◀ Back 1 2 3 4 5 Next ▶▶

Select All Set

FIG. 51: F9



Control Panel for Managing Advertising Campaigns

Directory Management Campaign Management Ad-Spot Management

Standard Demonstration Mode

Select Virtual Kiosks

Client Account: DISNEY Client Account No: 7145001 User Name: John Smith

Select the Virtual Kiosks on which the Advertisement will run.

P-S	S-S	V-S	S-P-S	R-S	I-S	C-S	All
Virtual Kiosk Name	Virtual Kiosk Serial Number	Installation Domain	Physical Location (if applicable)	Activity Indices	Ad Spot Rate (\$/impression)	Add Ad	
Virtual Kiosk Name 1	090987-098	http://www.installationdomain1.html	Location 1	activity_indices \$/impression		<input type="checkbox"/>	
Virtual Kiosk Name 2	090987-099	http://www.installationdomain2.html	Location 2	activity_indices \$/impression		<input type="checkbox"/>	
Virtual Kiosk Name 3	090987-098	http://www.installationdomain3.html	Location 3	activity_indices \$/impression		<input type="checkbox"/>	
Virtual Kiosk Name 4	090987-099	http://www.installationdomain4.html	Location 4	activity_indices \$/impression		<input type="checkbox"/>	
Virtual Kiosk Name 5	090987-098	http://www.installationdomain5.html	Location 5	activity_indices \$/impression		<input type="checkbox"/>	

Back 1 2 3 4 5 Next

Select All Set

FIG. 5.1 F10

040/1046



Control Panel for Managing Advertising Campaigns

Directory Management

Campaign Management

Ad Spot Management

Standard Demonstration Mode

Select Virtual Kiosks

Client Account: DISNEY

Client Account No: 7145001

User Name: John Smith

Select the Virtual Kiosks on which the Advertisement will run.

P-S	S-S	V-S	S-P-S	R-S	I-S	C-S	All
Virtual Kiosk Name	Virtual Kiosk Serial Number	Installation Domain	Physical Location (if applicable)	Activity Indices	Ad Spot Rate (\$/impression)	Add Ad	
Virtual Kiosk Name 1	090987-098	http://www.installationdomain1.html	Location 1	activity indices	\$/impression	<input type="checkbox"/>	
Virtual Kiosk Name 2	090987-099	http://www.installationdomain2.html	Location 2	activity indices	\$/impression	<input type="checkbox"/>	
Virtual Kiosk Name 3	090987-098	http://www.installationdomain3.html	Location 3	activity indices	\$/impression	<input type="checkbox"/>	
Virtual Kiosk Name 4	090987-099	http://www.installationdomain4.html	Location 4	activity indices	\$/impression	<input type="checkbox"/>	
Virtual Kiosk Name 5	090987-098	http://www.installationdomain5.html	Location 5	activity indices	\$/impression	<input type="checkbox"/>	

041/1046

Back 1 2 3 4 5 Next

Set

FIG. 51.F11



Control Panel for Managing Advertising Campaigns

Directory Management | Campaign Management | Ad-Spot Management

Standard Demonstration Mode

Client Account: DISNEY | Client Account No: 7145001 | User Name: John Smith

Select the Virtual Kiosks on which the Advertisement will run.

P-S	S-S	V-S	S-P-S	R-S	I-S	C-S	All
Virtual Kiosk Name	Virtual Kiosk Serial Number	Installation Domain	Physical Location (if applicable)	Activity Indices	Ad Spot Rate (\$/impression)	Add Ad	
Virtual Kiosk Name 1	090987-088	http://www.installationdomain1.html	Location 1	activity_indices \$/impression	<input type="checkbox"/>	<input type="checkbox"/>	
Virtual Kiosk Name 2	090987-089	http://www.installationdomain2.html	Location 2	activity_indices \$/impression	<input type="checkbox"/>	<input type="checkbox"/>	
Virtual Kiosk Name 3	090987-098	http://www.installationdomain3.html	Location 3	activity_indices \$/impression	<input type="checkbox"/>	<input type="checkbox"/>	
Virtual Kiosk Name 4	090987-099	http://www.installationdomain4.html	Location 4	activity_indices \$/impression	<input type="checkbox"/>	<input type="checkbox"/>	
Virtual Kiosk Name 5	090987-088	http://www.installationdomain5.html	Location 5	activity_indices \$/impression	<input type="checkbox"/>	<input type="checkbox"/>	

◀ Back 1 2 3 4 5 Next ▶▶

842/9046

Select All Set

FIG. 5.1 F12



Control Panel for Managing Advertising Campaigns

Directory Management

Campaign Management

Ad-Spot Management

Standard Demonstration Mode

SALE DATE

Client Account: DISNEY

Client Account No: 7145001

User Name: John Smith

Set the Start Date on which the Advertisement will begin to run.

January 2002		S	M	T	W	T	F	S
			1	2	3	4	5	
6	7	8	9	10	11	12		
13	14	15	16	17	18	19		
20	21	22	23	24	25	26		
27	28	29	30	31				

843/1046

Set

FIG. 51 F13



Control Panel for Managing Advertising Campaigns

Directory Management

Campaign Management

Ad-Spot Management

Standard Demonstration Mode

SALES REPRESENTATIVE

Client Account: DISNEY

Client Account No: 7145001

User Name: John Smith

Set the maximum number of times the Advertisement may run.

- 1 X/hr
- 2 X/hr
- 5 X/hr
- 10 X/hr

844/1046



FIG. 5.1.F14



Directory Management | Campaign Management | Ad-Spot Management

Standard Demonstration Mode

Virtual Kiosk Advertisement Spots

Client Account: DISNEY | Client Account No: 7145001 | User Name: John Smith

Please confirm the Advertisement(s) that has been placed on each Virtual Kiosk below. You may view the Advertisement(s) associated with the Virtual Kiosk by clicking on its View Advertisements button.

Virtual Kiosk Name	Virtual Kiosk Type	Virtual Kiosk Code	Virtual Kiosk Serial Number	Installation Domain	Physical Location (if applicable)	Placed Advertisements
Trek® Cycles 2002	Type goes here		090987-098	http://www.trek.com/cycles.html	Norwalk, CT	View Advertisements
Jaz® Discs 2002	Type goes here		090987-099	http://www.jaz.com/discs/jaz.html	Greenwich, CT	View Advertisements
Gatorade USA 2002	Type goes here		080987-088	http://www.gatorade.com	Miami, FL	View Advertisements
Just Do It!	Type goes here		090987-099	http://www.nike.com/sneakers/pump-air.html	Norwalk, CT	View Advertisements
Trek® Cycles 2002	Type goes here		090987-098	http://www.trek.com/cycles.html	Greenwich, CT	View Advertisements

44 | Back 1 2 3 4 5 Next | >>

Back | Place Ad Spot | Order

FIG. 5.1 F15

845/1046



Directory Management

Campaign Management

Ad-Spot Management

Standard Demonstration Mode

Virtual Kiosk

Client Account: DISNEY

Client Account No: 7145001

User Name: John Smith

Set the Relative Order for each Advertisement to run on the Virtual Kiosk. If you wish to remove an Advertisement from the Ad-Spot Order, then enter a "0" in the Relative Order textbox. Then click Set to save your changes.

Virtual Kiosk Name: Jaz@ Discs 2002

URL of Advertisement

<http://www.trek.com/cycles.html>

<http://www.jaz.com/discs/jaz.html>

<http://www.gatorade.com>

Title

Trek@ Cycles 2002

Jaz@ Discs 2002

Gatorade USA 2002

Relative Order

1

2

3

046/11046



FIG. 57 F16



Control Panel for Managing Advertising Campaigns

Directory Management | Campaign Management | Ad Spot Management

Standard Demonstration Mode

Control Panel for Managing Advertising Campaigns

Client Account: DISNEY | Client Account No: 7145001 | User Name: John Smith

Ad-Spot Order No. 1234567 has been placed. Please review the Order Information below to confirm it.

Virtual Kiosk Name: Trek® Cycles 2002

Virtual Kiosk Type Code: Type goes here

Virtual Kiosk Serial Number: 090987-098

Installation Domain: http://www.trek.com/cycles.html

Physical Location (if applicable): Norwalk, CT

Ad-Spot Place on this Virtual Kiosk:
Title 1
Title 2
Title 3

« | « Back 1 2 3 4 5 Next » | »

Back Confirm

FIG. 51 F17

847/1046



Directory Management

Campaign Management

Ad-Spot Management

Control Panel for Managing Advertising Campaigns

Standard Demonstration Mode

Select Ad-Spot Order

Client Account: DISNEY | Client Account No: 7145001 | User Name: John Smith

Select the Ad-Spot Order you wish to modify.

Ad-Spot Order Number

- 1209978901
- 1209978932
- 1209978456
- 1209978678
- 1209978222

Date Placed

- 01/20/2003
- 02/04/2003
- 03/25/2003
- 04/01/2003
- 05/14/2003

◀◀ | ◀ Back 1 2 3 4 5 Next ▶▶▶

840/1040

FIG. 51 F18



Central Panel for Managing Advertising Campaigns

Directory Management | Campaign Management | Ad-Spot Management

Standard Demonstration Mode

Client Account: DISNEY | Client Account No: 7145001 | User Name: John Smith

Advertisements have been placed on the Virtual Kiosks below. You may view the Advertisement(s) associated with the Virtual Kiosk by clicking on its View Advertisements button. Click Update Advertisements to modify your Advertisement Placements.

Virtual Kiosk Name	Virtual Kiosk Code	Virtual Kiosk Type	Virtual Kiosk Serial Number	Installation Domain	Physical Location (if applicable)	Placed Advertisements
Trek@ Cycles 2002	Type goes here		090987-098	http://www.trek.com/cycles.html	Norwalk, CT	View Advertisements
Jaz@ Discs USA 2002	Type goes here		090987-099	http://www.jaz.com/discs/jaz.html	Greenwich, CT	View Advertisements
Gatorade USA 2002	Type goes here		090987-098	http://www.gatorade.com	Miami, FL	View Advertisements
Just Do It!	Type goes here		090987-099	http://www.nike.com/sneakers/pump-air.html	Norwalk, CT	View Advertisements
Trek@ Cycles 2002	Type goes here		090987-098	http://www.trek.com/cycles.html	Greenwich, CT	View Advertisements

849/1046

44 | Back 1 2 3 4 5 Next > | >>

[Back](#) [Update Advertisements](#) [Next](#)

FIG. 51 F19



Control Panel for Managing Advertising Campaigns

Directory Management

Campaign Management

Ad-Spot Management

Standard Demonstration Mode

[View Advertisement](#)

Client Account: DISNEY

Client Account No: 7145001

User Name: John Smith

Set the Relative Order for each Advertisement to run on the Virtual Kiosk. If you wish to remove an Advertisement from the Ad-Spot Order, then enter a "0" in the Relative Order textbox. Then click Set to save your changes.

Virtual Kiosk Name: Jaz@ Discs 2002

URL of Advertisement

<http://www.trek.com/cycles.html>

<http://www.jaz.com/discs/jaz.html>

<http://www.gatorade.com>

Title

Trek@ Cycles 2002

Jaz@ Discs 2002

Gatorade USA 2002

Relative Order

850/1046



FIG. 51 F20



Directory Management Campaign Management Ad-Spot Management

Standard Demonstration Mode

Client Account: DISNEY Client Account No: 7145001 User Name: John Smith

Configure selected advertisement(s) that is to run in the Registered Virtual Kiosk Advertising Campaign. Click the Select Virtual Kiosks button to select the Virtual Kiosks on which the Advertisement will run. Click the Set Date button to set the Start Date on which the Advertisement will begin to run. Click the Set Frequency button to set the maximum number of times the Advertisement may run per hour.

URL of Advertisement	Title	Virtual Kiosks	Start Date	Frequency
http://www.trek.com/cycles.html	Trek® Cycles 2002	Select Virtual Kiosks	09/20/02	10 X/hr
http://www.jaz.com/discs/jaz.html	Jaz® Discs 2002	Select Virtual Kiosks	10/30/02	5 X/hr
http://www.gatorade.com	Gatorade USA 2002	Select Virtual Kiosks	07/10/02	2 X/hr
http://www.nike.com/sneakers/pump-air.html	Just Do It!	Select Virtual Kiosks	01/02/02	10 X/hr
http://www.trek.com/cycles.html	Trek® Cycles 2002	Select Virtual Kiosks	09/20/02	5 X/hr

851/1046

Back 1 2 3 4 5 Next

Back Advertisement Next

FIG. 51 F21



Control Panel for Managing Advertising Campaigns

Directory Management Campaign Management Ad-Spot Management

Standard Demonstration Mode

SEARCH VIRTUAL KIOSKS

Client Account: DISNEY Client Account No: 7145001 User Name: John Smith

Select the Virtual Kiosks on which the Advertisement will run.

P-S	S-S	V-S	S-P-S	R-S	I-S	C-S	All
Virtual Kiosk Name	Virtual Kiosk Serial Number	Installation Domain	Physical Location (if applicable)	Activity Indices	Ad Spot Rate (\$/impression)	Add Ad	
Virtual Kiosk Name 1	090987-088	http://www.installationdomain1.html	Location 1	activity_indices	\$/impression	<input type="checkbox"/>	
Virtual Kiosk Name 2	090987-089	http://www.installationdomain2.html	Location 2	activity_indices	\$/impression	<input type="checkbox"/>	
Virtual Kiosk Name 3	090987-088	http://www.installationdomain3.html	Location 3	activity_indices	\$/impression	<input type="checkbox"/>	
Virtual Kiosk Name 4	090987-089	http://www.installationdomain4.html	Location 4	activity_indices	\$/impression	<input type="checkbox"/>	
Virtual Kiosk Name 5	090987-088	http://www.installationdomain5.html	Location 5	activity_indices	\$/impression	<input type="checkbox"/>	

Back 1 2 3 4 5 Next

Save All Set

FIG. 51 F22

052/1046



Directory Management | Campaign Management | Ad-Spot Management

Standard Demonstration Mode

Virtual Kiosks

Client Account: DISNEY | Client Account No: 7145001 | User Name: John Smith

Select the Virtual Kiosks on which the Advertisement will run.

P-S	S-S	V-S	S-P-S	R-S	I-S	C-S	All
Virtual Kiosk Name	Virtual Kiosk Serial Number	Installation Domain	Physical Location (if applicable)	Activity Indices	Ad Spot Rate (\$/Impression)	Add Ad	
Virtual Kiosk Name 1	090987-098	http://www.installationdomain1.html	Location 1	activity indices	\$/Impression	<input type="checkbox"/>	
Virtual Kiosk Name 2	090987-099	http://www.installationdomain2.html	Location 2	activity indices	\$/Impression	<input type="checkbox"/>	
Virtual Kiosk Name 3	090987-098	http://www.installationdomain3.html	Location 3	activity indices	\$/Impression	<input type="checkbox"/>	
Virtual Kiosk Name 4	090987-099	http://www.installationdomain4.html	Location 4	activity indices	\$/Impression	<input type="checkbox"/>	
Virtual Kiosk Name 5	090987-098	http://www.installationdomain5.html	Location 5	activity indices	\$/Impression	<input type="checkbox"/>	

Back 1 2 3 4 5 Next

053/1046

Save All Save

FIG. 51 F23



Control Panel for Managing Advertising Campaigns

Directory Management | Campaign Management | Ad-Spot Management

Standard Demonstration Mode

Client Account: DISNEY | Client Account No: 7145001 | User Name: John Smith

Select the Virtual Kiosks on which the Advertisement will run.

P-S		S-S		V-S		S-P-S		R-S		I-S		C-S		All	
Virtual Kiosk Name	Virtual Kiosk Serial Number	Installation Domain	Physical Location (if applicable)	Activity Indices	Ad Spot Rate (\$/impression)										
Virtual Kiosk Name 1	090987-098	http://www.installationdomain1.html	Location 1	activity_indices	\$/impression										
Virtual Kiosk Name 2	090987-099	http://www.installationdomain2.html	Location 2	activity_indices	\$/impression										
Virtual Kiosk Name 3	090987-098	http://www.installationdomain3.html	Location 3	activity_indices	\$/impression										
Virtual Kiosk Name 4	090987-099	http://www.installationdomain4.html	Location 4	activity_indices	\$/impression										
Virtual Kiosk Name 5	090987-098	http://www.installationdomain5.html	Location 5	activity_indices	\$/impression										

854/1046

◀◀ Back 1 2 3 4 5 Next ▶▶

Select All

FIG. 51 F24



Control Panel for Managing Advertising Campaigns

Directory Management | Campaign Management | Ad Spot Management

Standard Demonstration Mode

Select Virtual Kiosks

Client Account: DISNEY | Client Account No: 7145001 | User Name: John Smith

Select the Virtual Kiosks on which the Advertisement will run.

Virtual Kiosk Name	Virtual Kiosk Serial Number	Installation Domain	Physical Location (if applicable)	Activity Indices	Ad Spot Rate (\$/Impression)	Add Ad
Virtual Kiosk Name 1	090987-098	http://www.installationdomain1.html	Location 1	activity_indices	\$/Impression	<input type="checkbox"/>
Virtual Kiosk Name 2	090987-099	http://www.installationdomain2.html	Location 2	activity_indices	\$/Impression	<input type="checkbox"/>
Virtual Kiosk Name 3	090987-098	http://www.installationdomain3.html	Location 3	activity_indices	\$/Impression	<input type="checkbox"/>
Virtual Kiosk Name 4	090987-099	http://www.installationdomain4.html	Location 4	activity_indices	\$/Impression	<input type="checkbox"/>
Virtual Kiosk Name 5	090987-098	http://www.installationdomain5.html	Location 5	activity_indices	\$/Impression	<input type="checkbox"/>

Back 1 2 3 4 5 Next

Select All Set

FIG. 5.1 F24

055/1040



Control Panel for Managing Advertising Campaigns

Directory Management | Campaign Management | Ad-Spot Management

Standard Demonstration Mode

Client Account: DISNEY | Client Account No: 7145001 | User Name: John Smith

Select the Virtual Kiosks on which the Advertisement will run.

Virtual Kiosk Name	Virtual Kiosk Serial Number	Installation Domain	Physical Location (if applicable)	Activity Indices	Ad Spot Rate (\$/Impression)	Add Ad
Virtual Kiosk Name 1	090987-098	http://www.installationdomain1.html	Location 1	activity_indices	\$/impression	<input type="checkbox"/>
Virtual Kiosk Name 2	090987-099	http://www.installationdomain2.html	Location 2	activity_indices	\$/impression	<input type="checkbox"/>
Virtual Kiosk Name 3	090987-098	http://www.installationdomain3.html	Location 3	activity_indices	\$/impression	<input type="checkbox"/>
Virtual Kiosk Name 4	090987-099	http://www.installationdomain4.html	Location 4	activity_indices	\$/impression	<input type="checkbox"/>
Virtual Kiosk Name 5	090987-098	http://www.installationdomain5.html	Location 5	activity_indices	\$/impression	<input type="checkbox"/>

826/1046

4 | Back 1 2 3 4 5 Next >>

Save All Save

FIG. 51 F25



Control Panel for Managing Advertising Campaigns

Directory Management

Campaign Management

Ad-Spot Management

Standard Demonstration Mode

Select Virtual Kiosks

Client Account: DISNEY Client Account No: 7145001 User Name: John Smith

Select the Virtual Kiosks on which the Advertisement will run.

P-S	S-S	V-S	S-P-S	R-S	I-S	C-S	All
Virtual Kiosk Name	Virtual Kiosk Serial Number	Installation Domain	Physical Location (if applicable)	Activity Indices	Ad Spot Rate (\$/impression)	Add Ad	
Virtual Kiosk Name 1	090987-098	http://www.installationdomain1.html	Location 1	activity_indices	\$/impression	<input type="checkbox"/>	
Virtual Kiosk Name 2	090987-099	http://www.installationdomain2.html	Location 2	activity_indices	\$/impression	<input type="checkbox"/>	
Virtual Kiosk Name 3	090987-098	http://www.installationdomain3.html	Location 3	activity_indices	\$/impression	<input type="checkbox"/>	
Virtual Kiosk Name 4	090987-099	http://www.installationdomain4.html	Location 4	activity_indices	\$/impression	<input type="checkbox"/>	
Virtual Kiosk Name 5	090987-098	http://www.installationdomain5.html	Location 5	activity_indices	\$/impression	<input type="checkbox"/>	

Back 1 2 3 4 5 Next

057/1046

Select All Select

FIG. 51 F26



Control Panel for Managing Advertising Campaigns

Directory Management

Campaign Management

Ad-Spot Management

Standard Demonstration Mode

Select Virtual Kiosks

Client Account: DISNEY

Client Account No: 7145001

User Name: John Smith

Select the Virtual Kiosks on which the Advertisement will run.

P-S	S-S	V-S	S-P-S	R-S	I-S	C-S	All
Virtual Kiosk Name	Virtual Kiosk Serial Number	Installation Domain	Physical Location (if applicable)	Activity Indices	Ad Spot Rate (\$/Impression)	Add Ad	
Virtual Kiosk Name 1	090987-098	http://www.installationdomain1.html	Location 1	activity_indices	\$/Impression	<input type="checkbox"/>	
Virtual Kiosk Name 2	090987-099	http://www.installationdomain2.html	Location 2	activity_indices	\$/Impression	<input type="checkbox"/>	
Virtual Kiosk Name 3	090987-098	http://www.installationdomain3.html	Location 3	activity_indices	\$/Impression	<input type="checkbox"/>	
Virtual Kiosk Name 4	090987-099	http://www.installationdomain4.html	Location 4	activity_indices	\$/Impression	<input type="checkbox"/>	
Virtual Kiosk Name 5	090987-098	http://www.installationdomain5.html	Location 5	activity_indices	\$/Impression	<input type="checkbox"/>	

◀◀ Back 1 2 3 4 5 Next ▶▶

858/1046

Select All

FIG. 5 F27

Control Panel for Managing Advertising Campaigns



Directory Management | Campaign Management | Ad-Spot Management

Standard Demonstration Mode

Select Virtual Kiosks

Client Account: DISNEY | Client Account No: 7145001 | User Name: John Smith

Select the Virtual Kiosks on which the Advertisement will run.

P-S	S-S	V-S	S-P-S	R-S	I-S	C-S	All	
Virtual Kiosk Name	Virtual Kiosk Serial Number	Installation Domain	Physical Location (if applicable)	Activity Indices	Ad Spot Rate (\$/impression)	Add Ad		
Virtual Kiosk Name 1	090987-098	http://www.installationdomain1.html	Location 1	activity_indices	\$/impression	<input type="checkbox"/>		
Virtual Kiosk Name 2	090987-099	http://www.installationdomain2.html	Location 2	activity_indices	\$/impression	<input type="checkbox"/>		
Virtual Kiosk Name 3	090987-098	http://www.installationdomain3.html	Location 3	activity_indices	\$/impression	<input type="checkbox"/>		
Virtual Kiosk Name 4	090987-099	http://www.installationdomain4.html	Location 4	activity_indices	\$/impression	<input type="checkbox"/>		
Virtual Kiosk Name 5	090987-098	http://www.installationdomain5.html	Location 5	activity_indices	\$/impression	<input type="checkbox"/>		

44 | Back 1 2 3 4 5 Next | >>

859/1046

Select All

FIG. 51F28



Control Panel for Managing Advertising Campaigns

Directory Management

Campaign Management

Ad-Spot Management

Standard Demonstration Mode

Start Date

Client Account: DISNEY

Client Account No: 7145001

User Name: John Smith

Set the Start Date on which the Advertisement will begin to run.

S	M	T	W	T	F	S
6	7	8	9	10	11	12
13	14	15	16	17	18	19
20	21	22	23	24	25	26
27	28	29	30	31		

860/1046

Start

FIG. 5.1.F29



Control Panel for Managing Advertising Campaigns

Directory Management

Campaign Management

Ad. Spot Management

Standard Demonstration Mode



Client Account: DISNEY

Client Account No: 7145001

User Name: John Smith

Set the maximum number of times the Advertisement may run.

- 1 X/hr
- 2 X/hr
- 5 X/hr
- 10 X/hr

8601/1046

FIG. 51F30



Control Panel for Managing Advertising Campaigns

Directory Management | Campaign Management | Ad-Spot Management

Standard Demonstration Mode

SALES ADVERTISING

Client Account: DISNEY | Client Account No: 7145001 | User Name: John Smith

Select the Advertisement(s) which you wish to run in the selected Virtual Kiosk Advertising Campaign by checking its Add to Campaign checkbox. You may Preview any Advertisement by clicking on its URL in the list below. To remove an Advertisement simply uncheck its Add to Campaign checkbox.

URL of Advertisement	Title	Creator / Author	Owner	Add to Campaign
http://www.trek.com/cycles.html	Trek® Cycles 2002	Trek creator	Trek, Inc.	<input type="checkbox"/>
http://www.jaz.com/discs/jaz.html	Jaz® Discs 2002	Omega Creator	Omega	<input type="checkbox"/>
http://www.trek.com/cycles.html	Gatorade USA 2002	Gatorade Creator	Gatorade	<input type="checkbox"/>
http://www.jaz.com/discs/jaz.html	Just Do It!	Nike Creator	Nike	<input type="checkbox"/>
http://www.trek.com/cycles.html	Trek® Cycles 2002	Trek creator	Trek, Inc.	<input type="checkbox"/>

862/1046

44 | < Back 1 2 3 4 5 Next > | >>

Back No

FIG. 51.F31

863/1046



Tutorials
• Brandkey Promote

Promote

Branded Products and Services

Promote branded products and services by building, running and managing Promotional Campaigns on Multi-Mode Virtual Kloosks delivered to Consumers.

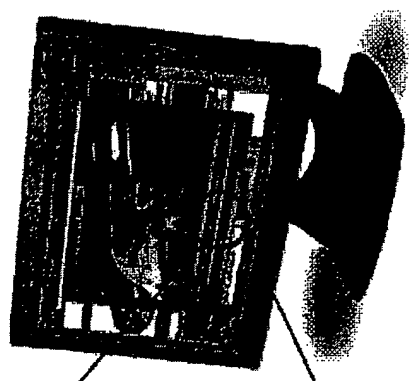
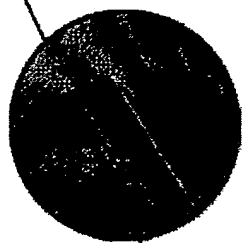

FIG. 52A



Brandkey systems

Brandkey create

Brandkey deliver

Brandkey advertise

Brandkey promote

Brandkey systems | Brandkey create | Brandkey deliver | Brandkey advertise | Brandkey promote

Brandkey Promote Subsystem Benefits - Standard Demonstration Mode

- ▶ Brand Managers
- ▶ Advertising Agents
- ▶ Promotional Agents
- ▶ Full Service Agents
- ▶ Marketing Consultants
- ▶ Brand Consultants
- ▶ Trademark Attorneys

The Brandkey Promote™ Subsystem offers brand managers and their promotional agents a simple and convenient way of creating, executing and managing promotional campaigns designed to run on networks of multi-mode Virtual Kiosks that have been deployed at internet-based consumer touchpoints. This Brandkey subsystem enables promoters and agents to generate Virtual Kiosk Promotional Directories specifying on which deployed Virtual Kiosks the promoter and agents are permitted to run promotional campaigns while preserving the rights and obligations of the users of the Brandkey Systems™ Network.

864/1040

FIG. 52B

865/1046

Home | About Us | Investors | Careers | Site Map | Contact Us | Help | Log



Brandkey systems | Brandkey create | Brandkey deliver | Brandkey advertise | Brandkey promote

Virtual Kiosk Promotion Campaign Management Suite - Standard Demonstration Mode

► Launch Control Panel for Managing Promotional Campaigns

Client Account: DISNEY | Client Account No: 7145001 | User Name: John Smith

Text P: 162

FIG.5ZC1



Directory Management

Campaign Management

Promo-Sac: Management

Control Panel for Managing Promotional Campaigns

Standard Demonstration Mode

Control Panel for Managing Promotional Campaigns

Client Account: DISNEY

Client Account No: 7145001

User Name: John Smith

Text Here.

866/1046

FIG. 5ZC2



Control Panel for Managing Promotional Campaigns

Directory Management

Campaign Management

Promo-Soc. Management

Standard Demonstration Mode

Directory Management

Client Account: DISNEY

Client Account No: 7145001

User Name: John Smith

Text Here.

06/1/04

FIG. 52C3



Control panel for Managing Promotional Campaigns

Directory Management

Campaign Management

Promo-Spec. Management

Standard Demonstration Mode

Select Promotional Directory Type

Client Account: DISNEY Client Account No: 7145001 User Name: John Smith

Select the Type of Advertising Directory you wish to Generate.

- General Promotional Directory
- Brand-Specific Promotional Directory

000/1046



FIG. SZCY



Control Panel for Managing Promotional Campaigns

Directory Management

Campaign Management

Proms-Spot Management

Standard Demonstration Mode

Select Virtual Kiosk Types

Client Account: DISNEY

Client Account No: 7145001

User Name: John Smith

Specify the Types of Virtual Kiosks to be listed in the General Virtual Kiosk Promotional Directory.

- Product-Specific (P-S) Virtual Kiosks
- Service-Specific (S-S) Virtual Kiosks
- Vendor-Specific (V-S) Virtual Kiosks
- Service-Provider Specific (S-P-S) Virtual Kiosks
- Retailer-Specific (R-S) Virtual Kiosks (having registered Vendor's shelf rights)
- Industry-Specific (I-S) Virtual Kiosks (having registered Vendor's shelf rights)
- Corporate-Specific (C-S) Virtual Kiosks

869/1046

Back button inserted

Back

FIG. 52CS



Control Panel for Managing Promotional Campaigns

Directory Management

Campaign Management

Promo-Spot Management

Standard Demonstration Mode

View the General Virtual Kiosk Promotional Directory

Client Account: DISNEY

Client Account No: 7145001

User Name: John Smith

Please assign a name to the General Virtual Kiosk Promotional Directory you wish to Generate.

Name Directory:

870/1046



FIG. 5ZC 6



Control Panel for Managing Promotional Campaigns

Directory Management | Campaign Management | Prom-Spec. Management

Standard Demonstration Mode

Generate the General Virtual Kiosk Promotional Directory

Client Account: DISNEY

Client Account No: 7145001

User Name: John Smith

Please click the Generate button to create the General Virtual Kiosk Promotional Directory.

Back

Generate Directory

FIG. 52C7

811/1046



Control Panel for Managing Promotional Campaigns

Directory Management Campaign Management Promoc-Spot Management

Standard Demonstration Mode

The General Virtual Kiosk Promotional Directory

Client Account: DISNEY Client Account No: 7145001 User Name: John Smith

General Virtual Kiosk Promotional Directory

Virtual Kiosk Serial Number	Virtual Kiosk Type Code	Virtual Kiosk Sponsor	Virtual Kiosk Display Mode	Virtual Kiosk Installation Domain	Physical Location of Virtual Kiosk (if known or Applicable)	Virtual Kiosk User Activity Indices	Ad Spot Rate (\$/impression)
90009060	PS	Sponsor	Tri-Mode	http://www.nike.com	Cosco; Norwalk, CT	activity_indices	\$/impression
90009061	MS	Sponsor	Dual-Mode	http://www.nike.com	Cosco; Norwalk, CT	activity_indices	\$/impression
90009062	RS	Sponsor	Tri-Mode	http://www.nike.com	Cosco; Norwalk, CT	activity_indices	\$/impression
90009063	PS	Sponsor	Tri-Mode	http://www.nike.com	Cosco; Norwalk, CT	activity_indices	\$/impression
90009064	IS	Sponsor	Dual-Mode	http://www.nike.com	Cosco; Norwalk, CT	activity_indices	\$/impression

44 | Back 1 2 3 4 5 Next | >>

Download PDF copy of the General Virtual Kiosk Promotional Directory



FIG. 52C8

012/1046



Control Panel for Managing Promotional Campaigns

Directory Management

Campaign Management

Promo-Spot Management

Standard Demonstration Mode

SEARCH FOR BRAND ENTITIES

Client Account: DISNEY

Client Account No: 7145001

User Name: John Smith

Search for the Brand Entities associated with your Client Account, which you wish to include in this Brand-Specific Virtual Kiosk Promotional Directory. You may search by Trademark, Service Descriptor, Product Descriptor, or Brand Entity Name. Enter the Search Criteria in the textbox, select the Brand-Related Key from the dropdown menu, and then click the Search button to initiate the Brand Entity search.

Search for:

By: Trademark

813/1046

Search

FIG. 52C9



Control Panel for Managing Promotional Campaigns

Directory Management

Campaign Management

Promo-Site Management

Standard Demonstration Mode

Select Brand Entities

Client Account: DISNEY

Client Account No: 7145001

User Name: John Smith

Below are listed the Brand Entities that matched your Search Criteria. Please select the ones you wish to add to the Brand-Specific Virtual Kiosk Promotional Directory by checking the Add checkbox.

Brand Entity	Brand Entity Owner	Trademark / Service Mark	Product Descriptor / Service Descriptor	No. of Products / Services	Add
Here will go the brand entity	Here will go the brand owner	Here will go the trade mark	Here will go the product name	Here will go the No. of products	<input type="checkbox"/>
Here will go the brand entity	Here will go the brand owner	Here will go the trade mark	Here will go the product name	Here will go the No. of products	<input type="checkbox"/>
Here will go the brand entity	Here will go the brand owner	Here will go the trade mark	Here will go the product name	Here will go the No. of products	<input type="checkbox"/>
Here will go the brand entity	Here will go the brand owner	Here will go the trade mark	Here will go the product name	Here will go the No. of products	<input type="checkbox"/>
Here will go the brand entity	Here will go the brand owner	Here will go the trade mark	Here will go the product name	Here will go the No. of products	<input type="checkbox"/>

◀ ◀ ◀ Back 1 2 3 4 5 Next ▶ ▶ ▶

Back Next

FIG. SIC 10

074 / 1046



Control Panel for Managing Promotional Campaigns

[Directory Management](#) |
 [Campaign Management](#) |
 [Promo-Spot Management](#) |
 [Virtual Kiosks](#)

Standard Demonstration Mode

SELECT VIRTUAL KIOSK TYPE

Client Account: DISNEY |
 Client Account No: 7145001 |
 User Name: John Smith

Specify the Types of Virtual Kiosks to be listed in the General-Type Virtual Kiosk Promotional Directory.

- Product-Specific (P-S) Virtual Kiosks
- Service-Specific (S-S) Virtual Kiosks
- Vendor-Specific (V-S) Virtual Kiosks
- Service-Provider Specific (S-P-S) Virtual Kiosks
- Retailer-Specific (R-S) Virtual Kiosks (having registered vendor's shelf rights)
- Industry-Specific (I-S) Virtual Kiosks (having registered vendor's shelf rights)
- Corporate-Specific (C-S) Virtual Kiosks (having registered vendor's shelf rights)

075/1046

[Back](#) [Next](#)

FIG. 52C11



Control Panel for Managing Promotional Campaigns

Directory Management

Campaign Management

Promo-Sec: Management

Standard Demonstration Mode

MANAGING BRAND-SPECIFIC VIRTUAL KIOSK PROMOTIONAL DIRECTORY

Client Account: DISNEY

Client Account No: 7145001

User Name: John Smith

Please assign a name to the Brand-Specific Virtual Kiosk Promotional Directory you wish to Generate.

Name Directory:

076/1046

Back Next

FIG. 52C12



Directory Management

Campaign Management

Promo-Spec Management

Control Panel for Managing Promotional Campaigns

Standard Demonstration Mode

[Generate and Brand-Specific Virtual Kiosk Promotional Directory](#)

Client Account: DISNEY

Client Account No: 7145001

User Name: John Smith

Please click the Generate button to create the Brand-Specific Virtual Kiosk Promotional Directory.

877/1046

Back

Generate Directory

FIG. 52C13



Control Panel for Managing Promotional Campaigns

Directory Management | Campaign Management | Promote-Spot Management

Standard Demonstration Mode

[The Brand-Specific Virtual Kiosk Promotional Directory](#)

Client Account: DISNEY | Client Account No: 7145001 | User Name: John Smith

Brand-Specific Virtual Kiosk Promotional Directory

Virtual Kiosk Serial Number	Virtual Kiosk Type Code	Virtual Kiosk Sponsor	Virtual Kiosk Display Mode	Virtual Kiosk Installation Domain	Physical Location of Virtual Kiosk (if known or Applicable)	Virtual Kiosk User Activity Indices	Ad Spot Rate (\$/Impression)
90009060	PS	Sponsor	Tri-Mode	http://www.nike.com	Cosco; Norwalk, CT	activity indices	\$/Impression
90009061	MS	Sponsor	Dual-Mode	http://www.nike.com	Cosco; Norwalk, CT	activity indices	\$/Impression
90009062	RS	Sponsor	Tri-Mode	http://www.nike.com	Cosco; Norwalk, CT	activity indices	\$/Impression
90009063	PS	Sponsor	Tri-Mode	http://www.nike.com	Cosco; Norwalk, CT	activity indices	\$/Impression
90009064	IS	Sponsor	Dual-Mode	http://www.nike.com	Cosco; Norwalk, CT	activity indices	\$/Impression

070/1046

« Back 1 2 3 4 5 Next »

Download PDF copy of the Brand-Specific Virtual Kiosk Promotional Directory

Download

FIG. 52C14



Control Panel for Managing Promotional Campaigns

Directory Management

Campaign Management

Promo-Spec Management

Standard Demonstration Mode

[Select Promotional Directory](#)

Client Account: DISNEY

Client Account No: 7145001

User Name: John Smith

Select the Type of Advertising Directory you wish to Modify.

- General Promotional Directory
- Brand-Specific Promotional Directory

879/1046

Next Next

FIG. 52C15



Control Panel for Managing Promotional Campaigns

Directory Management | Campaign Management | Promotional Management

Standard Demonstration Mode

Select Brand-Specific Promotional Directory

Client Account: DISNEY | Client Account No: 7145001 | User Name: John Smith

Select the Brand-Specific Promotional Directory you wish to modify.

Brand-Specific Promotional Directory

Promotional Directory	Date Created
Promotional Directory.1	01/20/2003
Promotional Directory.2	02/04/2003
Promotional Directory.3	03/25/2003
Promotional Directory.4	04/01/2003
Promotional Directory.5	05/14/2003

4 | 4 Back 1 2 3 4 5 Next > >>

890/1046

FIG. 52.C16

Control Panel for Managing Promotional Campaigns



Directory Management Campaign Management Prom-Spec. Management

Control Panel for Managing Promotional Campaigns

Standard Demonstration Mode

Search Brand Entities

Client Account: DISNEY Client Account No: 7145001 User Name: John Smith

You have selected the following Brand Entities for the Brand-Specific Promotional Directory. To remove a Brand Entity simply uncheck its selected checkbox. Click Next to specify the Virtual Kiosk types for the Brand-Specific Promotional Directory. Click Add Brands to select more Brand Entities to add to the Brand-Specific Promotional Directory.

Brand Entity	Brand Entity Owner	Trademark/Serviceemark	Product/Service Descriptor	No. of Product/Services	Selected
Brand Entity 1	Brand Entity Owner 1	Trademark 1	Product Descriptor 1	Product 1	<input checked="" type="checkbox"/>
Brand Entity 2	Brand Entity Owner 2	Trademark 2	Product Descriptor 2	Product 2	<input checked="" type="checkbox"/>
Brand Entity 3	Brand Entity Owner 3	Trademark 3	Product Descriptor 3	Product 3	<input checked="" type="checkbox"/>
Brand Entity 4	Brand Entity Owner 4	Trademark 4	Product Descriptor 4	Product 4	<input checked="" type="checkbox"/>
Brand Entity 5	Brand Entity Owner 5	Trademark 5	Product Descriptor 5	Product 5	<input checked="" type="checkbox"/>

881/1046

Back 1 2 3 4 5 Next

Back Add Brands Note

FIG. 52C17



Control Panel for Managing Promotional Campaigns

Directory Management

Campaign Management

Promo-Spec Management

Standard Demonstration Mode

Search for Brand Entities

Client Account: DISNEY

Client Account No: 7145001

User Name: John Smith

Search for the Brand Entities associated with your Client Account, which you wish to include in this Brand-Specific Virtual Kiosk Promotional Directory. You may search by Trademark, Service mark, Product Descriptor, or Brand Entity Name. Enter the Search Criteria in the textbox, select the Brand-Related Key from the dropdown menu, and then click the Search button to initiate the Brand Entity search.

Search for:

By: Trademark

884 1046

FIG. 52c18

Back

NSearch



Directory Management Campaign Management Promote-Spot Management

Standard Demonstration Mode

Select Brand Entities

Client Account: DISNEY Client Account No: 7145001 User Name: John Smith

Below are listed the Brand Entities that matched your Search Criteria. Please select the ones you wish to add to the Brand-Specific Virtual Kiosk Promotional Directory by checking the Add checkbox.

Brand Entity	Brand Entity Owner	Trademark / Service Mark	Product Descriptor / Service Descriptor	No. of Products / Services	Add
Here will go the brand entity	Here will go the brand entity owner	Here will go the trade mark	Here will go the product name	Here will go the No. of products	<input type="checkbox"/>
Here will go the brand entity	Here will go the brand entity owner	Here will go the trade mark	Here will go the product name	Here will go the No. of products	<input type="checkbox"/>
Here will go the brand entity	Here will go the brand entity owner	Here will go the trade mark	Here will go the product name	Here will go the No. of products	<input type="checkbox"/>
Here will go the brand entity	Here will go the brand entity owner	Here will go the trade mark	Here will go the product name	Here will go the No. of products	<input type="checkbox"/>
Here will go the brand entity	Here will go the brand entity owner	Here will go the trade mark	Here will go the product name	Here will go the No. of products	<input type="checkbox"/>

003/1046

4 | 4 | Back 1 2 3 4 5 Next | >>



FIG. 52C19



Control Panel for Managing Promotional Campaigns

Directory Management

Campaign Management

Promo-Spec Management

Standard Demonstration Mode

Select Virtual Kiosk Types

Client Account: DISNEY | Client Account No: 7145001 | User Name: John Smith

Specify the Types of Virtual Kiosks to be listed in the Brand-Specific Virtual Kiosk Promotional Directory.

- Product-Specific (P-S) Virtual Kiosks
- Service-Specific (S-S) Virtual Kiosks
- Vendor-Specific (V-S) Virtual Kiosks
- Service-Provider Specific (S-P-S) Virtual Kiosks
- Retailer-Specific (R-S) Virtual Kiosks (having registered vendor's shelf rights)
- Industry-Specific (I-S) Virtual Kiosks (having registered vendor's shelf rights)
- Corporate-Specific (C-S) Virtual Kiosks (having registered vendor's shelf rights)

884/1046



FIG. 52C20



Control Panel for Managing Promotional Campaigns

Directory Management Campaign Management Promo-Soc Management

Standard Demonstration Mode

Name: Brand Specific, User: KISS, Promotional Directory

Client Account: DISNEY Client Account No: 7145001 User Name: John Smith

You may change the Name assigned to this Brand-Specific Promotional Directory.

Directory Name: Directory 1

885/1040



FIG. 51CZ1



Control Panel for Managing Promotional Campaigns

Directory Management | Campaign Management | Promis-Spot Management

Standard Demonstration Mode

Managing Brand-Specific Virtual Kiosk Promotional Directory

Client Account: DISNEY | Client Account No: 7145001 | User Name: John Smith

Please click the Modify button to modify the Brand-Specific Virtual Kiosk Promotional Directory.

8806/1046

Modify Directory

FIG. 52C22



Control Panel for Managing Promotional Campaigns

Directory Management Campaign Management Prom-Spot Management
 Managing Promotional Campaigns

Standard Demonstration Mode

The Brand-Specific Virtual Kiosk Promotional Directory

Client Account: DISNEY Client Account No: 7145001 User Name: John Smith

Brand-Specific Virtual Kiosk Promotional Directory

Virtual Kiosk Serial Number	Virtual Kiosk Type Code	Virtual Kiosk Sponsor	Virtual Kiosk Display Mode	Virtual Kiosk Installation Domain	Physical Location of Virtual Kiosk (if known or Applicable)	Virtual Kiosk User Activity Indices	Ad Spot Rate (\$/Impression)
90009060	PS	Sponsor	Tri-Mode	http://www.nike.com	Cosco; Norwalk, CT	activity indices	\$/Impression
90009061	MS	Sponsor	Dual-Mode	http://www.nike.com	Cosco; Norwalk, CT	activity indices	\$/Impression
90009062	RS	Sponsor	Tri-Mode	http://www.nike.com	Cosco; Norwalk, CT	activity indices	\$/Impression
90009063	PS	Sponsor	Tri-Mode	http://www.nike.com	Cosco; Norwalk, CT	activity indices	\$/Impression
90009064	IS	Sponsor	Dual-Mode	http://www.nike.com	Cosco; Norwalk, CT	activity indices	\$/Impression

007/1046

44 | Back 1 2 3 4 5 Next >>>

Download

Download PDF copy of the Brand-Specific Virtual Kiosk Promotional Directory

FIG. 51C23



Control Panel for Managing Promotional Campaigns

Directory Management

Campaign Management

Promo-Spot Management

Standard Demonstration Mode

Select General Promotional Directory

Client Account: DISNEY

Client Account No: 7145001

User Name: John Smith

Select the General Promotional Directory you wish to modify.

General Promotional Directory

Promotional Directory 1

Promotional Directory 2

Promotional Directory 3

Promotional Directory 4

Promotional Directory 5

Date Created

01/20/2003

02/04/2003

03/25/2003

04/01/2003

05/14/2003

44 | Back 1 2 3 4 5 Next |>>

888/1046

FIG. 51C24

Control Panel for Managing Promotional Campaigns



Directory Management Campaign Management Promote-Spot Management

Standard Demonstration Mode

Select Virtual Kiosk Type

Client Account: DISNEY Client Account No: 7145001 User Name: John Smith

Specify the Types of Virtual Kiosks to be listed in the General Promotional Directory. The Virtual Kiosk Types you have previously chosen are checked by default. If you wish to add a Virtual Kiosk Type, then check its checkbox. If you wish to remove a Virtual Kiosk Type, then uncheck its checkbox.

- Product-Specific (P-S) Virtual Kiosks
- Service-Specific (S-S) Virtual Kiosks
- Vendor-Specific (V-S) Virtual Kiosks
- Service-Provider Specific (S-P-S) Virtual Kiosks
- Retailer-Specific (R-S) Virtual Kiosks (having registered Vendor's shelf rights)
- Industry-Specific (I-S) Virtual Kiosks (having registered Vendor's shelf rights)
- Corporate-Specific (C-S) Virtual Kiosks

089/1046



FIG. 52C25



Control Panel for Managing Promotional Campaigns

Directory Management | Campaign Management | Prom-Spot Management

Standard Demonstration Mode

Name: General Promotional Directory

Client Account: DISNEY | Client Account No: 7145001 | User Name: John Smith

You may change the Name assigned to this General Promotional Directory.

Directory Name: Promotional Directory 1

890/1046

Back Next

FIG. 5ZC26



Control Panel for Managing Promotional Campaigns

Directory Management

Campaign Management

Promo-Spec Management

Standard Demonstration Mode

Modify Promotional Directory

Client Account: DISNEY

Client Account No: 7145001

User Name: John Smith

Please click the Modify button to modify the selected General Advertising Directory.

09/10/40

Back

Modify Directory

FIG. 52C 27



Directory Management Campaign Management Proms-Spot Management

Standard Demonstration Mode

Download Promotional Directory

Client Account: DISNEY Client Account No: 7145001 User Name: John Smith

General Virtual Kiosk Promotional Directory

Virtual Kiosk Serial Number	Virtual Kiosk Type Code	Virtual Kiosk Sponsor	Virtual Kiosk Display Mode	Virtual Kiosk Installation Domain	Physical Location of Virtual Kiosk (if known or Applicable)	Virtual Kiosk User Activity Indices	Ad Spot Rate (\$/Impression)
90009060	PS	Sponsor	Tri-Mode	http://www.nike.com	Cosco; Norwalk, CT	activity indices	\$/Impression
90009061	MS	Sponsor	Dual-Mode	http://www.nike.com	Cosco; Norwalk, CT	activity indices	\$/Impression
90009062	RS	Sponsor	Tri-Mode	http://www.nike.com	Cosco; Norwalk, CT	activity indices	\$/Impression
90009063	PS	Sponsor	Tri-Mode	http://www.nike.com	Cosco; Norwalk, CT	activity indices	\$/Impression
90009064	IS	Sponsor	Dual-Mode	http://www.nike.com	Cosco; Norwalk, CT	activity indices	\$/Impression

Navigation icons: Back, 1, 2, 3, 4, 5, Next

09271046

Download

Download PDF copy of the selected General Promotional Directory

FIG. 5ZC28



Control Panel for Managing Promotional Campaigns

Directory Management

Campaign Management

Promo-Spot Management

Standard Demonstration Mode

~~Campaign Management~~

[Client Account: DISNEY

| Client Account No: 7145001

| User Name: John Smith

Text Here.

893/1046

FIG. SZDI



Control Panel for Managing Promotional Campaigns

Directory Management | Campaign Management | Promote-Spot Management

Standard Demonstration Mode

Virtual Kiosk Promotional Campaign Registration

Client Account: DISNEY | Client Account No: 7145001 | User Name: John Smith

Please enter the information below in order to Register the new Virtual Kiosk Promotional Campaign.

Name of Virtual Kiosk Promoting Campaign:

Virtual Kiosk Promoting Campaign Registration Number:

Campaign Start Date:

Campaign End Date:

894/1046

Next

FIG. 5202



Control Panel for Managing Promotional Campaigns

Directory Management | Campaign Management | Promo-Spot Management

Standard Demonstration Mode

Select Virtual Kiosk Promotional Directory Type

Client Account: DISNEY | Client Account No: 7145001 | User Name: John Smith

Please select which Type of Virtual Kiosk Promotional Directory you wish to use to build the new Virtual Kiosk Promotional Campaign.

- General Virtual Kiosk Promotional Directory
- Brand-Specific Virtual Kiosk Promotional Directory

895/1046

Back Next

FIG. SZD3



Directory Management Campaign Management Promo-Spec Management

Standard Demonstration Mode

Select Virtual Kiosk Promotional Directory

Client Account: DISNEY Client Account No: 7145001 User Name: John Smith

Please select the General Virtual Kiosk Promotional Directory you wish to use to build the new Virtual Kiosk Promotional Campaign.

General Virtual Kiosk Directory Name	Date Created
Irek@Cycles.2002	09/06/02
Jaz@Discs.2002	01/30/02
Gatorade_USA.2002	06/10/02
Irek@Cycles.2002	11/03/02
Jaz@Discs.2002	09/06/02

4 | 4 Back 1 2 3 4 5 Next | >>

Please select the Brand-Specific Virtual Kiosk Promotional Directory you wish to use to build the new Virtual Kiosk Promotional Campaign.

Brand-Specific Virtual Kiosk Directory Name	Date Created
Irek@Cycles.2002	09/06/02
Jaz@Discs.2002	01/30/02
Gatorade_USA.2002	06/10/02
Irek@Cycles.2002	11/03/02
Jaz@Discs.2002	06/10/02

4 | 4 Back 1 2 3 4 5 Next | >>

896/1046

Inverted → back button

FIG. 5ZD4



Standard Demonstration Mode

Client Account: DISNEY

Client Account No: 7145001

User Name: John Smith

Please select the Virtual Kiosks you wish to add to the Virtual Kiosk Promotional Campaign, by checking their Add to Campaign checkboxes. Click the Register button to Register the new Virtual Kiosk Promotional Campaign.

Virtual Kiosk Name	Virtual Kiosk Serial Number	Virtual Kiosk Code	Virtual Kiosk Type	Installation Domain	Physical Location (if applicable)	Add to Campaign
Trek® Cycles 2002	090987-098	Type goes here	Type goes here	http://www.trek.com/cycles.html	Norwalk, CT	<input type="checkbox"/>
Jaz® Discs 2002	090987-099	Type goes here	Type goes here	http://www.jaz.com/discs/jaz.html	Greenwich, CT	<input type="checkbox"/>
Jaz® Discs 2002	090987-099	Type goes here	Type goes here	http://www.jaz.com/discs/jaz.html	Miami, FL	<input type="checkbox"/>
Trek® Cycles 2002	090987-098	Type goes here	Type goes here	http://www.gatorade.com	Miami, FL	<input type="checkbox"/>
Jaz® Discs 2002	090987-099	Type goes here	Type goes here	http://www.nike.com/sneakers/pump-air.html	Norwalk, CT	<input type="checkbox"/>

44 | Back 1 2 3 4 5 Next |>>

Back Register Campaign

FIG. 5ZDS

897/11046



[Directory Management](#) | [Campaign Management](#) | [Promo-Spot Management](#)
[Manage Campaigns](#) | [Virtual Kiosk Promotional Campaigns](#)

Standard Demonstration Mode

Select Virtual Kiosk Promotional Campaign

Client Account: DISNEY | Client Account No: 7145001 | User Name: John Smith

Select the Virtual Kiosk Promotional Campaign you wish to Modify by clicking on its Name.

Name of Virtual Kiosk Promo Campaign	Owner of Virtual Kiosk Promo Campaign	Date of Campaign Registration	Campaign Registration Number	Campaign Status
Virtual Kiosk Promo	Owner of Virtual kiosk	02-03-02	Virtual Kiosk Number	Running
Virtual Kiosk Promo	Owner of Virtual kiosk	02-03-02	Virtual Kiosk Number	Running
Virtual Kiosk Promo	Owner of Virtual kiosk	02-03-02	Virtual Kiosk Number	Expired
Virtual Kiosk Promo	Owner of Virtual kiosk	02-03-02	Virtual Kiosk Number	Stopped
Virtual Kiosk Promo	Owner of Virtual kiosk	02-03-02	Virtual Kiosk Number	Stopped

44 | Back 12345 Next >>>

898/1046

FIG. 51D6



Control Panel for Managing Promotional Campaigns

Directory Management

Campaign Management

Promo-Spot Management

Standard Demonstration Mode

Modify the Virtual Kiosk Promotional Campaign

Client Account: DISNEY | Client Account No: 7145001 | User Name: John Smith

You may Modify the Virtual Kiosk Promotional Campaign by Adding or Removing Virtual Kiosks from the Campaign.

Master Data Record for Virtual Kiosk Promotional Campaign

Name of Virtual Kiosk Promo Campaign: Trek® Cycles 2002
 Owner of Virtual Kiosk Promo Campaign: Trek, Inc.
 Date of Campaign Registration: 02-03-02
 Campaign Registration Number: 09890-0989

Virtual Kiosk Added to Subnetwork of the Campaign	Virtual Kiosk No.	Virtual Kiosk Type Code	Virtual Kiosk Display Mode	Virtual Kiosk Installation Domain	Physical Location of Virtual Kiosk (if known or Applicable)	Virtual Kiosk User Activity Indices	Promo Spot Rate (\$/Impression)	Promo Spot Order Placed on Virtual Kiosks
<input checked="" type="checkbox"/>	90009060	PS	Codes	http://www.nike.com	Cosco; Norwalk, CT	activity indices	\$/Impression	ASO#26
<input type="checkbox"/>	90009061	VS	Codes	http://www.nike.com	Cosco; Norwalk, CT	activity indices	\$/Impression	ASO#29, ASO#32
<input type="checkbox"/>	90009062	RS	Codes	http://www.nike.com	Cosco; Norwalk, CT	activity indices	\$/Impression	ASO#56
<input type="checkbox"/>	90009063	PS	Codes	http://www.nike.com	Cosco; Norwalk, CT	activity indices	\$/Impression	ASO#98
<input type="checkbox"/>	90009064	IS	Codes	http://www.nike.com	Cosco; Norwalk, CT	activity indices	\$/Impression	ASO#30

899/1046

◀ Back 1 2 3 4 5 Next ▶▶

Apply Exit

FIG. 52D7



Control Panel for Managing Promotional Campaigns

Directory Management Campaign Management

Promo-Spec Management

Register Campaigns Modify Campaigns Add New Campaigns

Standard Demonstration Mode

Run Virtual Kiosk Promotional Campaigns

Client Account: DISNEY | Client Account No: 7145001 | User Name: John Smith

Select the Virtual Kiosk Promotional Campaigns you wish to Run by checking their Run checkboxes and then clicking the Run Promotional Campaign button.

- Virtual Kiosk Promotional Campaign Run
- Virtual Kiosk Promotional Campaign 1
- Virtual Kiosk Promotional Campaign 2
- Virtual Kiosk Promotional Campaign 3
- Virtual Kiosk Promotional Campaign 4

Run Campaign

Stop Virtual Kiosk Promotional Campaigns

Select the Virtual Kiosk Promotional Campaigns you wish to Stop by checking their Stop checkboxes and then clicking the Stop Promotional Campaign button.

- Virtual Kiosk Promotional Campaign Stop
- Virtual Kiosk Promotional Campaign 1
- Virtual Kiosk Promotional Campaign 2

FIG. 520.8

900/1046

Brandkey Promote Subsystem

Virtual Kiosk Promotional Campaign 3

Virtual Kiosk Promotional Campaign 4



Sub Campaign

901/1046

FIG. 52D9



Control Panel for Managing Promotional Campaigns

Directory Management Campaign Management

Promo-Spec Management

Standard Demonstration Mode

Select Virtual Kiosk Promotional Campaign

Client Account: DISNEY Client Account No: 7145001 User Name: John Smith

Select the Virtual Kiosk Promotional Campaign you wish to Monitor by clicking on its Name.

Name of Virtual Kiosk Promo Campaign	Owner of Virtual Kiosk Promo Campaign	Date of Campaign Registration	Campaign Registration Number	Campaign Status
<u>Virtual Kiosk Promo</u>	Owner of Virtual kiosk	02-03-02	Campaign Registration Number	Running
<u>Virtual Kiosk Promo</u>	Owner of Virtual kiosk	02-03-02	Campaign Registration Number	Running
<u>Virtual Kiosk Promo</u>	Owner of Virtual kiosk	02-03-02	Campaign Registration Number	Expired
<u>Virtual Kiosk Promo</u>	Owner of Virtual kiosk	02-03-02	Campaign Registration Number	Stopped
<u>Virtual Kiosk Promo</u>	Owner of Virtual kiosk	02-03-02	Campaign Registration Number	Stopped

Back 1 2 3 4 5 Next

902/1046

FIG. 52D10



Directory Management

Campaign Management

Promo-Spot Management

Control Panel for Managing Promotional Campaigns

Standard Demonstration Mode

Client Account: DISNEY

Client Account No: 7145001

User Name: John Smith

You may review the statistics compiled for the selected Virtual Kiosk Promotional Campaign.

Promotional Campaign Name:	Promo campaign name
Promotional Campaign Registration Number:	Registration Number
Promotional Campaign Registration's Date:	06/09/02
Promotional Campaign Status:	Running
Total Number of Promotions placed on Campaign's Subnetwork of Virtual Kiosks:	5221
Total Number of Promotions Run on Campaign's Subnetwork of Virtual Kiosks:	3521
Total Number of Promo Spot Interruptions on Retail-Specific Virtual Kiosks on Subnetwork:	275
Total Number of Brand Information Networks Accessed by Consumers Response to PromoSpot Displayed on Virtual Kiosks:	679

903/1046

FIG. 52DU

6/18/2003



Control Panel for Managing Promotional Campaigns

Directory Management | Campaign Management | Promote-Spot Management

Standard Demonstration Mode

Promote-Spot Management

Client Account: DISNEY

Client Account No: 7145001

User Name: John Smith

Text Here.

964/1046

FIG. 5Z E1



Control Panel for Managing Promotional Campaigns

Directory Management | Campaign Management | Promo-Spot Management

Standard Demonstration Mode

Select Virtual Kiosk Promotional Campaign

Client Account: DISNEY | Client Account No: 7145001 | User Name: John Smith

Select the Registered Virtual Kiosk Promotional Campaign on which you wish to place Promo-Spot Orders.

Name of Virtual Kiosk Promotional Campaign	Registration Number	Registration Date
Irek@ Cycles 2002	09890-0989	02-03-02
Jaz@ Discs 2002	09890-0995	02-03-02
Gatorade USA 2002	09890-1001	02-03-02
Just Do It!	09890-1025	02-03-02
Irek@ Cycles 2002	09890-0989	02-03-02

Back 1 2 3 4 5 Next

905/1046

FIG. 52E2



Standard Demonstration Mode

Select Promotions

Client Account: DISNEY Client Account No: 7145001 User Name: John Smith

Select the promotion(s) which you wish to run in the selected Virtual Kiosk Promotion Campaign by checking its Add to Campaign checkbox. You may Preview any Promotion by clicking on its URL in the list below.

URL of Promotion	Title	Creator / Author	Owner	Add to Campaign
http://www.trek.com/cycles.html	Trek® Cycles 2002	Trek creator	Trek, Inc.	<input type="checkbox"/>
http://www.jaz.com/discs/jaz.html	Jaz® Discs 2002	lomega Creator	lomega	<input type="checkbox"/>
http://www.trek.com/cycles.html	Gatorade USA 2002	Gatorade Creator	Gatorade	<input type="checkbox"/>
http://www.jaz.com/discs/jaz.html	Just Do It!	Nike Creator	Nike	<input type="checkbox"/>
http://www.trek.com/cycles.html	Trek® Cycles 2002	Trek creator	Trek, Inc.	<input type="checkbox"/>

44 | ◀ Back 1 2 3 4 5 Next ▶▶▶

Back Next

FIG. 52E3

906/1046



Control Panel for Managing Promotional Campaigns

Directory Management Campaign Management Promotional Management

Standard Demonstration Mode

Assign Promotions to Virtual Kiosks

Client Account: DISNEY Client Account No: 7145001 User Name: John Smith

Configure selected promotion(s) that is to run in the Registered Virtual Kiosk Promotional Campaign. Click the Select Virtual Kiosks button to select the Virtual Kiosks on which the promotion will run. Click the Set Date button to set the Start Date on which the promotion will begin to run. Click the Set Frequency button to set the maximum number of times the promotion may run per hour.

URL of promotion	Title	Virtual Kiosks	Start Date	Frequency
http://www.trek.com/cycles.html	Trek® Cycles 2002	Select Virtual Kiosks	09/20/02	10 X/hr
http://www.jaz.com/discs/jaz.html	Jaz® Discs 2002	Select Virtual Kiosks	10/30/02	5 X/hr
http://www.gatorade.com	Gatorade USA 2002	Select Virtual Kiosks	07/10/02	2 X/hr
http://www.nike.com/sneakers/pump-air.html	Just Do It!	Select Virtual Kiosks	01/02/02	10 X/hr
http://www.trek.com/cycles.html	Trek® Cycles 2002	Select Virtual Kiosks	09/20/02	5 X/hr

Back 1 2 3 4 5 Next

Back Next

FIG. SZEY



Control Panel for Managing Promotional Campaigns

Directory Management Campaign Management

Promo-Spot Management

Standard Demonstration Mode

Select Virtual Kiosks

Client Account: DISNEY Client Account No: 7145001 User Name: John Smith

Select the Virtual Kiosks on which the Promotion will run.

P-S	S-S	V-S	S-P-S	R-S	I-S	C-S	All
Virtual Kiosk Name	Virtual Kiosk Serial Number	Installation Domain	Physical Location (If applicable)	Activity Indices	Promo Spot Rate (\$/Impression)	Add Promo	
Virtual Kiosk Name 1	090987-098	http://www.installationdomain1.html	Location 1	activity_indices	\$/impression	<input type="checkbox"/>	
Virtual Kiosk Name 2	090987-099	http://www.installationdomain2.html	Location 2	activity_indices	\$/impression	<input type="checkbox"/>	
Virtual Kiosk Name 3	090987-098	http://www.installationdomain3.html	Location 3	activity_indices	\$/impression	<input type="checkbox"/>	
Virtual Kiosk Name 4	090987-099	http://www.installationdomain4.html	Location 4	activity_indices	\$/impression	<input type="checkbox"/>	
Virtual Kiosk Name 5	090987-098	http://www.installationdomain5.html	Location 5	activity_indices	\$/impression	<input type="checkbox"/>	

Back 1 2 3 4 5 Next

Select All Set

FIG. 52E5

9.18/1046



Directory Management | Campaign Management | Promo Spot Management

Standard Demonstration Mode

Select Virtual Kiosks

Client Account: DISNEY | Client Account No: 7145001 | User Name: John Smith

Select the Virtual Kiosks on which the Promotion will run.

Virtual Kiosk Name	Virtual Kiosk Serial Number	Installation Domain	Physical Location (if applicable)	Activity Indices	Promo Spot Rate (\$/impression)	Add Promo
Virtual Kiosk Name 1	090987-098	http://www.installationdomain1.html	Location 1	activity_indices	\$/impression	<input type="checkbox"/>
Virtual Kiosk Name 2	090987-099	http://www.installationdomain2.html	Location 2	activity_indices	\$/impression	<input type="checkbox"/>
Virtual Kiosk Name 3	090987-098	http://www.installationdomain3.html	Location 3	activity_indices	\$/impression	<input type="checkbox"/>
Virtual Kiosk Name 4	090987-099	http://www.installationdomain4.html	Location 4	activity_indices	\$/impression	<input type="checkbox"/>
Virtual Kiosk Name 5	090987-098	http://www.installationdomain5.html	Location 5	activity_indices	\$/impression	<input type="checkbox"/>

Navigation: Back 1 2 3 4 5 Next

Select All Set

FIG. 51E6

909/1046



Control Panel for Managing Promotional Campaigns

Directory Management Campaign Management Promote Spot Management

Standard Demonstration Mode

Select Virtual Kiosks

Client Account: DISNEY Client Account No: 7145001 User Name: John Smith

Select the Virtual Kiosks on which the Promotion will run.

Virtual Kiosk Name	Virtual Kiosk Serial Number	Installation Domain	Physical Location (if applicable)	Activity Indices	Promo Spot Rate (\$/impression)	Add Promo
Virtual Kiosk Name 1	090987-098	http://www.installationdomain1.html	Location 1	activity_indices	\$/impression	<input type="checkbox"/>
Virtual Kiosk Name 2	090987-099	http://www.installationdomain2.html	Location 2	activity_indices	\$/impression	<input type="checkbox"/>
Virtual Kiosk Name 3	090987-098	http://www.installationdomain3.html	Location 3	activity_indices	\$/impression	<input type="checkbox"/>
Virtual Kiosk Name 4	090987-099	http://www.installationdomain4.html	Location 4	activity_indices	\$/impression	<input type="checkbox"/>
Virtual Kiosk Name 5	090987-098	http://www.installationdomain5.html	Location 5	activity_indices	\$/impression	<input type="checkbox"/>

Back 1 2 3 4 5 Next

FIG. 51E7



Control Panel for Managing Promotional Campaigns

Directory Management | Campaign Management | Promos-Spot Management

Standard Demonstration Mode

Select Virtual Kiosks

Client Account: DISNEY | Client Account No: 7145001 | User Name: John Smith

Select the Virtual Kiosks on which the Promotion will run.

Virtual Kiosk Name	Virtual Kiosk Serial Number	Installation Domain	Physical Location (if applicable)	Activity Indices	Promo Spot Rate (\$/impression)	Add Promo
Virtual Kiosk Name 1	090987-098	http://www.installationdomain1.html	Location 1	activity_indices	\$/impression	<input type="checkbox"/>
Virtual Kiosk Name 2	090987-099	http://www.installationdomain2.html	Location 2	activity_indices	\$/impression	<input type="checkbox"/>
Virtual Kiosk Name 3	090987-098	http://www.installationdomain3.html	Location 3	activity_indices	\$/impression	<input type="checkbox"/>
Virtual Kiosk Name 4	090987-099	http://www.installationdomain4.html	Location 4	activity_indices	\$/impression	<input type="checkbox"/>
Virtual Kiosk Name 5	090987-098	http://www.installationdomain5.html	Location 5	activity_indices	\$/impression	<input type="checkbox"/>

Back 1 2 3 4 5 Next

Select All Select

Fig. 51E8

911/1046



Control Panel for Managing Promotional Campaigns

Directory Management Campaign Management Promotional Management

Standard Demonstration Mode

Client Account: DISNEY Client Account No: 7145001 User Name: John Smith

Select the Virtual Kiosks on which the Promotion will run.

Virtual Kiosk Name	Virtual Kiosk Serial Number	Installation Domain	Physical Location (if applicable)	Activity Indices	Promo Spot Rate (\$/Impression)	Add Promo
Virtual Kiosk Name 1	090987-098	http://www.installationdomain1.html	Location 1	activity_indices	\$/impression	<input type="checkbox"/>
Virtual Kiosk Name 2	090987-099	http://www.installationdomain2.html	Location 2	activity_indices	\$/impression	<input type="checkbox"/>
Virtual Kiosk Name 3	090987-098	http://www.installationdomain3.html	Location 3	activity_indices	\$/impression	<input type="checkbox"/>
Virtual Kiosk Name 4	090987-099	http://www.installationdomain4.html	Location 4	activity_indices	\$/impression	<input type="checkbox"/>
Virtual Kiosk Name 5	090987-098	http://www.installationdomain5.html	Location 5	activity_indices	\$/impression	<input type="checkbox"/>

912/1046

Back 1 2 3 4 5 Next

Select All

FIG. 52E9



Control Panel for Managing Promotional Campaigns

Directory Management Campaign Management Promote Spot Management

Standard Demonstration Mode

Virtual Kiosks

Client Account: DISNEY Client Account No: 7145001 User Name: John Smith

Select the Virtual Kiosks on which the Promotion will run.

Virtual Kiosk Name	Virtual Kiosk Serial Number	Installation Domain	Physical Location (if applicable)	Activity Indices	Promo Spot Rate (\$/impression)	Add Promo
Virtual Kiosk Name 1	090987-098	http://www.installationdomain1.html	Location 1	activity_indices	\$/impression	<input type="checkbox"/>
Virtual Kiosk Name 2	090987-099	http://www.installationdomain2.html	Location 2	activity_indices	\$/impression	<input type="checkbox"/>
Virtual Kiosk Name 3	090987-098	http://www.installationdomain3.html	Location 3	activity_indices	\$/impression	<input type="checkbox"/>
Virtual Kiosk Name 4	090987-099	http://www.installationdomain4.html	Location 4	activity_indices	\$/impression	<input type="checkbox"/>
Virtual Kiosk Name 5	090987-098	http://www.installationdomain5.html	Location 5	activity_indices	\$/impression	<input type="checkbox"/>

Back 1 2 3 4 5 Next

913/1046

Select All

FIG. 52E10



Control Panel for Managing Promotional Campaigns

Directory Management | Campaign Management | Promo Spot Management

Standard Demonstration Mode

Select Virtual Kiosks

Client Account: DISNEY | Client Account No: 7145001 | User Name: John Smith

Select the Virtual Kiosks on which the Promotion will run.

P-S	S-S	V-S	S-P-S	R-S	I-S	C-S	All
Virtual Kiosk Name	Virtual Kiosk Serial Number	Installation Domain	Physical Location (if applicable)	Activity Indices	Promo Spot Rate (\$/Impression)	Add Promo	
Virtual Kiosk Name 1	090987-098	http://www.installationdomain1.html	Location 1	activity indices	\$/Impression	<input type="checkbox"/>	
Virtual Kiosk Name 2	090987-099	http://www.installationdomain2.html	Location 2	activity indices	\$/Impression	<input type="checkbox"/>	
Virtual Kiosk Name 3	090987-098	http://www.installationdomain3.html	Location 3	activity indices	\$/Impression	<input type="checkbox"/>	
Virtual Kiosk Name 4	090987-099	http://www.installationdomain4.html	Location 4	activity indices	\$/Impression	<input type="checkbox"/>	
Virtual Kiosk Name 5	090987-098	http://www.installationdomain5.html	Location 5	activity indices	\$/Impression	<input type="checkbox"/>	

914/1046

Back 1 2 3 4 5 Next

Select All

FIG. 52E11



[Directory Management](#) |
 [Campaign Management](#) |
 [Promo Spot Management](#)

Standard Demonstration Mode

[Select Virtual Kiosks](#)

Client Account: DISNEY |
 Client Account No: 7145001 |
 User Name: John Smith

Select the Virtual Kiosks on which the Promotion will run.

P-S	S-S	V-S	S-P-S	R-S	I-S	C-S	All
Virtual Kiosk Name	Virtual Kiosk Serial Number	Installation Domain	Physical Location (if applicable)	Activity Indices	Promo Spot Rate (\$/impression)	Add Promo	
Virtual Kiosk Name 1	090987-098	http://www.installationdomain1.html	Location 1	activity_indices	\$/impression	<input type="checkbox"/>	
Virtual Kiosk Name 2	090987-099	http://www.installationdomain2.html	Location 2	activity_indices	\$/impression	<input type="checkbox"/>	
Virtual Kiosk Name 3	090987-098	http://www.installationdomain3.html	Location 3	activity_indices	\$/impression	<input type="checkbox"/>	
Virtual Kiosk Name 4	090987-099	http://www.installationdomain4.html	Location 4	activity_indices	\$/impression	<input type="checkbox"/>	
Virtual Kiosk Name 5	090987-098	http://www.installationdomain5.html	Location 5	activity_indices	\$/impression	<input type="checkbox"/>	

[Back](#) |
 [1](#) |
 [2](#) |
 [3](#) |
 [4](#) |
 [5](#) |
 [Next](#)

Selected |
 Selected

FIG. S1E12

915/1046



Control Panel for Managing Promotional Campaigns

Directory Management | Campaign Management | Promo Spot Management

Standard Demonstration Mode

Set Date

Client Account: DISNEY | Client Account No: 7145001 | User Name: John Smith

Set the Start Date on which the Promotion will begin to run.

Day	Jan 2002	Day	Day
S	1 2 3 4 5	F	S
6	7 8 9 10 11 12		
13	14 15 16 17 18 19		
20	21 22 23 24 25 26		
27	28 29 30 31		

946/1046

Set

FIG. SZE 13



Control Panel for Managing Promotional Campaigns

Directory Management

Campaign Management

Promo Spot Management

Standard Demonstration Mode

Set Promotions

Client Account: DISNEY | Client Account No: 7145001 | User Name: John Smith

Set the maximum number of times the Promotion may run.

- 1 X/hr
- 2 X/hr
- 5 X/hr
- 10 X/hr

917/1046

Set

FIG. 52E14



Control Panel for Managing Promotional Campaigns

Directory Management | Campaign Management | Promotional Spot Management

Standard Demonstration Mode

Common Virtual Kiosk Promotional Spot List

Client Account: DISNEY | Client Account No: 7145001 | User Name: John Smith

Please confirm the promotion(s) that has been placed on each Virtual Kiosk below. You may view the Promotion(s) associated with the Virtual Kiosk by clicking on its View promotions button.

Virtual Kiosk Name	Virtual Kiosk Code	Virtual Kiosk Type	Virtual Kiosk Serial Number	Installation Domain	Physical Location (if applicable)	Placed Promotions
Trek® Cycles 2002	Type goes here	090987-098	http://www.trek.com/cycles.html	Norwalk, CT	View Promotions	
Jaz® Discs 2002	Type goes here	090987-099	http://www.jaz.com/discs/jaz.html	Greenwich, CT	View Promotions	
Gatorade USA 2002	Type goes here	090987-098	http://www.gatorade.com	Miami, FL	View Promotions	
Just Do It!	Type goes here	090987-099	http://www.nike.com/sneakers/pump-air.html	Norwalk, CT	View Promotions	
Trek® Cycles 2002	Type goes here	090987-098	http://www.trek.com/cycles.html	Greenwich, CT	View Promotions	

4 | Back 1 2 3 4 5 Next |>>

[Back](#) [Place Promo Spot Order](#)

FIG. SZEIS

918/1046



Control Panel for Managing Promotional Campaigns

Directory Management

Campaign Management

Promo-Spot Management

Standard Demonstration Mode

View Promotions

Client Account: DISNEY

Client Account No: 7145001

User Name: John Smith

Set the Relative Order for each Promotion to run on the Virtual Kiosk. If you wish to remove a Promotion from the Promo-Spot Order, then enter a "0" in the Relative Order textbox. Then click Set to save you changes.

Virtual Kiosk Name: Jaz® Discs 2002

URL of Promotion

<http://www.trek.com/cycles.html>

<http://www.jaz.com/discs/jaz.html>

<http://www.gatorade.com>

Title

Trek® Cycles 2002

Jaz® Discs 2002

Gatorade USA 2002

Relative Order

1

2

3

909/1046

Create New Promotional Message

Set

FIG. 52E16



Control Panel for Managing Promotional Campaigns

Directory Management | Campaign Management | Prom-Spot Management

Standard Demonstration Mode

[View Promote](#)

Client Account: DISNEY | Client Account No: 7145001 | User Name: John Smith

Create new promotional message.

Message:

Background Color: Black

Message Font: Arial

Message Color: Black

920/1046

[View Message](#) [Save](#)

FIG. 5ZE17



Directory Management

Campaign Management

Promo-Spot Management

Control Panel for Managing Promotional Campaigns

Standard Demonstration Mode

www.brandkey.com

Client Account: DISNEY

Client Account No: 7145001

User Name: John Smith

Nike Ice Hockey Equipment on Sale Until November 1st. \$29.95

921/1046

Set

FIG. 52E18



Control Panel for Managing Promotional Campaigns

Directory Management Campaign Management Promo-Spot Management

Standard Demonstration Mode

Client Account: DISNEY Client Account No: 7145001 User Name: John Smith

Promo-Spot Order No.1234567 has been placed. Please review the Order information below to confirm it.

Virtual Kiosk Name: Trek® Cycles 2002

Virtual Kiosk Type Code: Type goes here

Virtual Kiosk Serial Number: 090987-098

Installation Domain: http://www.trek.com/cycles.html

Physical Location (if applicable): Norwalk, CT

Promo-Spot Place on this Virtual Kiosk: Title 1 Title 2 Title 3

Navigation buttons: Back, 1, 2, 3, 4, 5, Next

922/1046



FIG. 5ZE19



Control Panel for Managing Promotional Campaigns

Directory Management

Campaign Management

Promo-Spot Management

Standard Demonstration Mode

Select Promo-Spot Order

Client Account: DISNEY

Client Account No: 7145001

User Name: John Smith

Select the Promo-Spot Order you wish to modify.

Promo-Spot Order Number

- 1209978901
- 1209978932
- 1209978456
- 1209978678
- 1209978222

Date Placed

- 01/20/2003
- 02/04/2003
- 03/25/2003
- 04/01/2003
- 05/14/2003

4 | 4 Back 1 2 3 4 5 Next > >>

923/1046

FIG. 52E20



Directory Management

Campaign Management

Promo Spot Management

Standard Demonstration Mode

Confirm Virtual Kiosk Promotion and Placement

Client Account: DISNEY | Client Account No: 7145001 | User Name: John Smith

Promotions have been placed on the Virtual Kiosks below. You may view the Promotion(s) associated with the Virtual Kiosk by clicking on its View Promotions button. Click Update Promotions to modify your Promotion Placements.

Virtual Kiosk Name	Virtual Kiosk Type Code	Virtual Kiosk Type	Virtual Kiosk Serial Number	Installation Domain	Physical Location (if applicable)	Placed Promotions
Trek@ Cycles 2002	Type goes here	Type goes here	090987-098	http://www.trek.com/cycles.html	Norwalk, CT	View Promotions
Jaz@ Discs 2002	Type goes here	Type goes here	090987-099	http://www.jaz.com/discs/jaz.html	Greenwich, CT	View Promotions
Gatorade USA 2002	Type goes here	Type goes here	090987-098	http://www.gatorade.com	Miami, FL	View Promotions
Just Do It!	Type goes here	Type goes here	090987-099	http://www.nike.com/sneakers/pump-air.html	Norwalk, CT	View Promotions
Trek@ Cycles 2002	Type goes here	Type goes here	090987-098	http://www.trek.com/cycles.html	Greenwich, CT	View Promotions

4 | 4 Back 1 2 3 4 5 Next | >>

[Back](#) [Update Promotion](#) [Next](#)

FIG. SZE 21

924/1046



Control Panel for Managing Promotional Campaigns

Directory Management Campaign Management Promote Spot Management

Standard Demonstration Mode

Client Account: DISNEY Client Account No: 7145001 User Name: John Smith

Set the Relative Order for each Promotion to run on the Virtual Kiosk. If you wish to remove a Promotion from the Promo-Spot Order, then enter a "0" in the Relative Order textbox. Then click Set to save you changes.

Virtual Kiosk Name: Jaz@ Discs 2002

URL of Promotion	Title	Relative Order
http://www.trek.com/cycles.html	Trek@ Cycles 2002	1
http://www.jaz.com/discs/jaz.html	Jaz@ Discs 2002	2
http://www.gatorade.com	Gatorade USA 2002	3

925/1046

Create New Promotional Message Set

FIG. SZEZZ



Directory Management | Campaign Management | Promo-Spot Management

Standard Demonstration Mode



Client Account: DISNEY | Client Account No: 7145001 | User Name: John Smith

Create new promotional message.

Message: [Empty text box]

- Background Color: Black [Color swatch]
- Message Font: Arial [Font swatch]
- Message Color: Black [Color swatch]

926/1046

View Message Set

FIG. 52E23



Control Panel for Managing Promotional Campaigns

Directory Management
Promo Spot Management

Campaign Management

Standard Demonstration Mode

www.brandkey.com

Client Account: DISNEY

Client Account No: 7145001

User Name: John Smith

Nike Ice Hockey Equipment on Sale Until November 1st. \$29.95

929/1046



FIG. SZE 24



Directory Management | Campaign Management | Prom. Spot Management

Standard Demonstration Mode

Client Account: DISNEY | Client Account No: 7145001 | User Name: John Smith

Configure selected promotion(s) that is to run in the Registered Virtual Kiosk Promotional Campaign. Click the Select Virtual Kiosks button to select the Virtual Kiosks on which the promotion will run. Click the Set Date button to set the Start Date on which the promotion will begin to run. Click the Set Frequency button to set the maximum number of times the promotion may run per hour.

URL of promotion	Title	Virtual Kiosks	Start Date	Frequency
http://www.trek.com/cycles.html	Trek® Cycles 2002	Select Virtual Kiosks	09/20/02	10 X/hr
http://www.jaz.com/discs/jaz.html	Jaz® Discs 2002	Select Virtual Kiosks	10/30/02	5 X/hr
http://www.gatorade.com	Gatorade USA 2002	Select Virtual Kiosks	07/10/02	2 X/hr
http://www.nike.com/sneakers/pump-air.html	Just Do It!	Select Virtual Kiosks	01/02/02	10 X/hr
http://www.trek.com/cycles.html	Trek® Cycles 2002	Select Virtual Kiosks	09/20/02	5 X/hr

920/1046

◀ Back 1 2 3 4 5 Next ▶▶

Back Add Promotions Next

FIG. SIZES



Directory Management | Campaign Management | Promo Spot Management

Standard Demonstration Mode

Virtual Kiosks

Client Account: DISNEY | Client Account No: 7145001 | User Name: John Smith

Select the Virtual Kiosks on which the Promotion will run.

P-S	S-S	V-S	S-P-S	R-S	I-S	C-S	All
Virtual Kiosk Name	Virtual Kiosk Serial Number	Installation Domain	Physical Location (if applicable)	Activity Indices	Promo Spot Rate (\$/impression)	Add Promo	
Virtual Kiosk Name 1	090987-098	http://www.installationdomain1.html	Location 1	activity_indices	\$/impression	<input type="checkbox"/>	
Virtual Kiosk Name 2	090987-099	http://www.installationdomain2.html	Location 2	activity_indices	\$/impression	<input type="checkbox"/>	
Virtual Kiosk Name 3	090987-098	http://www.installationdomain3.html	Location 3	activity_indices	\$/impression	<input type="checkbox"/>	
Virtual Kiosk Name 4	090987-099	http://www.installationdomain4.html	Location 4	activity_indices	\$/impression	<input type="checkbox"/>	
Virtual Kiosk Name 5	090987-098	http://www.installationdomain5.html	Location 5	activity_indices	\$/impression	<input type="checkbox"/>	

◀◀ | 4 Back 1 2 3 4 5 Next ▶▶

929/1046

Select All

FIG. 52E 26



Directory Management | Campaign Management | Prom-Spot Management

Standard Demonstration Mode

Select Virtual Kiosks

Client Account: DISNEY | Client Account No: 7145001 | User Name: John Smith

Select the Virtual Kiosks on which the Promotion will run.

Virtual Kiosk Name	Virtual Kiosk Serial Number	Installation Domain	Physical Location (if applicable)	Activity Indices	Promo Spot Rate (\$/impression)	Add Promo
Virtual Kiosk Name 1	090987-098	http://www.installationdomain1.html	Location 1	activity_indices	\$/impression	<input type="checkbox"/>
Virtual Kiosk Name 2	090987-099	http://www.installationdomain2.html	Location 2	activity_indices	\$/impression	<input type="checkbox"/>
Virtual Kiosk Name 3	090987-098	http://www.installationdomain3.html	Location 3	activity_indices	\$/impression	<input type="checkbox"/>
Virtual Kiosk Name 4	090987-099	http://www.installationdomain4.html	Location 4	activity_indices	\$/impression	<input type="checkbox"/>
Virtual Kiosk Name 5	090987-098	http://www.installationdomain5.html	Location 5	activity_indices	\$/impression	<input type="checkbox"/>

4 | Back 1 2 3 4 5 Next >>

Select All

FIG. SZE27

930/1046



[Directory Management](#) |
 [Promo Spot Management](#) |
 [Campaign Management](#) |
 [Promo Spot Management](#)

Standard Demonstration Mode

Select Virtual Kiosks

Client Account: DISNEY |
 Client Account No: 7145001 |
 User Name: John Smith

Select the Virtual Kiosks on which the Promotion will run.

P-S	S-S	V-S	S-P-S	R-S	I-S	C-S	All
Virtual Kiosk Name	Virtual Kiosk Serial Number	Installation Domain	Physical Location (if applicable)	Activity Indices	Promo Spot Rate (\$/Impression)	Add Promo	
Virtual Kiosk Name 1	090987-098	http://www.installationdomain1.html	Location 1	activity_indices	\$/impression	<input type="checkbox"/>	
Virtual Kiosk Name 2	090987-099	http://www.installationdomain2.html	Location 2	activity_indices	\$/impression	<input type="checkbox"/>	
Virtual Kiosk Name 3	090987-098	http://www.installationdomain3.html	Location 3	activity_indices	\$/impression	<input type="checkbox"/>	
Virtual Kiosk Name 4	090987-099	http://www.installationdomain4.html	Location 4	activity_indices	\$/impression	<input type="checkbox"/>	
Virtual Kiosk Name 5	090987-098	http://www.installationdomain5.html	Location 5	activity_indices	\$/impression	<input type="checkbox"/>	

936/1046

◀ | ◀ Back 1 2 3 4 5 Next ▶ | ▶▶

Select All Set

FIG. 52E28



Control Panel for Managing Promotional Campaigns

Directory Management | Campaign Management | Promote Spot Management

Standard Demonstration Mode

Client Account: DISNEY | Client Account No: 7145001 | User Name: John Smith

Select the Virtual Kiosks on which the Promotion will run.

Virtual Kiosk Name	Virtual Kiosk Serial Number	Installation Domain	Physical Location (if applicable)	Activity Indices	Promo Spot Rate (\$/impression)	Add Promo
Virtual Kiosk Name 1	090987-098	http://www.installationdomain1.html	Location 1	activity_indices	\$/impression	<input type="checkbox"/>
Virtual Kiosk Name 2	090987-099	http://www.installationdomain2.html	Location 2	activity_indices	\$/impression	<input type="checkbox"/>
Virtual Kiosk Name 3	090987-098	http://www.installationdomain3.html	Location 3	activity_indices	\$/impression	<input type="checkbox"/>
Virtual Kiosk Name 4	090987-099	http://www.installationdomain4.html	Location 4	activity_indices	\$/impression	<input type="checkbox"/>
Virtual Kiosk Name 5	090987-098	http://www.installationdomain5.html	Location 5	activity_indices	\$/impression	<input type="checkbox"/>

44 | 4 Back 1 2 3 4 5 Next | >>

Select All | Set

FIG. 52E29

932/1046



Control Panel for Managing Promotional Campaigns

Directory Management | Campaign Management | Promotional Management

Standard Demonstration Mode

Client Account: DISNEY | Client Account No: 7145001 | User Name: John Smith

Select the Virtual Kiosks on which the Promotion will run:

P-S	S-S	V-S	S-P-S	P-S	I-S	C-S	All
Virtual Kiosk Name	Virtual Kiosk Serial Number	Installation Domain	Physical Location (if applicable)	Activity Indices	Promo Spot Rate (\$/impression)	Add Promo	
Virtual Kiosk Name 1	090987-098	http://www.installationdomain1.html	Location 1	activity_indices	\$/impression	<input type="checkbox"/>	
Virtual Kiosk Name 2	090987-099	http://www.installationdomain2.html	Location 2	activity_indices	\$/impression	<input type="checkbox"/>	
Virtual Kiosk Name 3	090987-098	http://www.installationdomain3.html	Location 3	activity_indices	\$/impression	<input type="checkbox"/>	
Virtual Kiosk Name 4	090987-099	http://www.installationdomain4.html	Location 4	activity_indices	\$/impression	<input type="checkbox"/>	
Virtual Kiosk Name 5	090987-098	http://www.installationdomain5.html	Location 5	activity_indices	\$/impression	<input type="checkbox"/>	

◀◀ Back 1 2 3 4 5 Next ▶▶

933/1046

Select All Set

FIG. 5ZE30



Control Panel for Managing Promotional Campaigns

Directory Management Campaign Management Promotional Management

Standard Demonstration Mode

Select Virtual Kiosks

Client Account: DISNEY Client Account No: 7145001 User Name: John Smith

Select the Virtual Kiosks on which the Promotion will run.

Virtual Kiosk Name	Virtual Kiosk Serial Number	Installation Domain	Physical Location (if applicable)	Activity Indices	Promo Spot Rate (\$/Impression)	Add Promo
Virtual Kiosk Name 1	090987-098	http://www.installationdomain1.html	Location 1	activity_indices	\$/Impression	<input type="checkbox"/>
Virtual Kiosk Name 2	090987-099	http://www.installationdomain2.html	Location 2	activity_indices	\$/Impression	<input type="checkbox"/>
Virtual Kiosk Name 3	090987-098	http://www.installationdomain3.html	Location 3	activity_indices	\$/Impression	<input type="checkbox"/>
Virtual Kiosk Name 4	090987-099	http://www.installationdomain4.html	Location 4	activity_indices	\$/Impression	<input type="checkbox"/>
Virtual Kiosk Name 5	090987-098	http://www.installationdomain5.html	Location 5	activity_indices	\$/Impression	<input type="checkbox"/>

44 | Back 1 2 3 4 5 Next >>>

Select All Set

FIG. 52E31

934/1046



Directory Management | Campaign Management | Promo-Spot Management

Standard Demonstration Mode

SEARCH FOR KIOSKS

Client Account: DISNEY | Client Account No: 7145001 | User Name: John Smith

Select the Virtual Kiosks on which the Promotion will run.

Virtual Kiosk Name	Virtual Kiosk Serial Number	Installation Domain	Physical Location (if applicable)	Activity Indices	Promo Spot Rate (\$/Impression)	Add Promo
Virtual Kiosk Name 1	090987-098	http://www.installationdomain1.html	Location 1	activity_indices	\$/Impression	<input type="checkbox"/>
Virtual Kiosk Name 2	090987-099	http://www.installationdomain2.html	Location 2	activity_indices	\$/Impression	<input type="checkbox"/>
Virtual Kiosk Name 3	090987-098	http://www.installationdomain3.html	Location 3	activity_indices	\$/Impression	<input type="checkbox"/>
Virtual Kiosk Name 4	090987-099	http://www.installationdomain4.html	Location 4	activity_indices	\$/Impression	<input type="checkbox"/>
Virtual Kiosk Name 5	090987-098	http://www.installationdomain5.html	Location 5	activity_indices	\$/Impression	<input type="checkbox"/>

Back 1 2 3 4 5 Next

935/1046

FIG. 5ZE3Z

Set



Directory Management Campaign Management Promo-Spot Management

Standard Demonstration Mode

Select Virtual Kiosks

Client Account: DISNEY Client Account No: 7145001 User Name: John Smith

Select the Virtual Kiosks on which the Promotion will run.

P-S S-S V-S S-P-S R-S I-S C-S All

Virtual Kiosk Name	Virtual Kiosk Serial Number	Installation Domain	Physical Location (if applicable)	Activity Indices	Promo Spot Rate (\$/Impression)	Add Promo
Virtual Kiosk Name 1	090987-098	http://www.installationdomain1.html	Location 1	activity_indices	\$/Impression	<input type="checkbox"/>
Virtual Kiosk Name 2	090987-099	http://www.installationdomain2.html	Location 2	activity_indices	\$/Impression	<input type="checkbox"/>
Virtual Kiosk Name 3	090987-098	http://www.installationdomain3.html	Location 3	activity_indices	\$/Impression	<input type="checkbox"/>
Virtual Kiosk Name 4	090987-099	http://www.installationdomain4.html	Location 4	activity_indices	\$/Impression	<input type="checkbox"/>
Virtual Kiosk Name 5	090987-098	http://www.installationdomain5.html	Location 5	activity_indices	\$/Impression	<input type="checkbox"/>

Back 1 2 3 4 5 Next

Select All

FIG. 5ZE33

936/1046



Control Panel for Managing Promotional Campaigns

Directory Management

Campaign Management

Promo-Spot Management

Standard Demonstration Mode

Client Account: DISNEY

Client Account No: 7145001

User Name: John Smith

Set the Start Date on which the Promotion will begin to run.

S	M	T	W	T	F	S
6	7	8	9	10	11	12
13	14	15	16	17	18	19
20	21	22	23	24	25	26
27	28	29	30	31		

937/1046

Sat

FIG. 5ZE34



Directory Management

Campaign Management

Promo Spot Management

Control Panel for Managing Promotional Campaigns

Standard Demonstration Mode

Client Account: DISNEY

Client Account No: 7145001

User Name: John Smith

Set the maximum number of times the Promotion may run.

- 1 X/hr
- 2 X/hr
- 5 X/hr
- 10 X/hr

98011046



FIG. 5ZE35



Control Panel for Managing Promotional Campaigns

Directory Management
Promo-Spot Management

Campaign Management

Promo-Spot Management

Standard Demonstration Mode

Client Account: DISNEY | Client Account No: 7145001 | User Name: John Smith

Select the promotion(s) which you wish to run in the selected Virtual Kiosk Promotion Campaign by checking its Add to Campaign checkbox. You may Preview any Promotion by clicking on its URL in the list below. To remove an Advertisement simply uncheck its Add to Campaign checkbox.

URL of Promotion	Title	Creator / Author	Owner	Add to Campaign
http://www.trek.com/cycles.html	Trek® Cycles 2002	Trek creator	Trek, Inc.	<input type="checkbox"/>
http://www.jaz.com/discs/jaz.html	Jaz® Discs 2002	lomega Creator	lomega	<input type="checkbox"/>
http://www.trek.com/cycles.html	Gatorade USA 2002	Gatorade Creator	Gatorade	<input type="checkbox"/>
http://www.jaz.com/discs/jaz.html	Just Do It!	Nike Creator	Nike	<input type="checkbox"/>
http://www.trek.com/cycles.html	Trek® Cycles 2002	Trek creator	Trek, Inc.	<input type="checkbox"/>

4 | < Back 1 2 3 4 5 Next > | >>

Back Next

FIG. 5ZE36

939/1046

940/1046

CONFIDENTIAL-BKS Networks, Inc.

BKS NETWORKS



BKS Invitational Presentation

© 2003 BKS Networks, Inc.

Plg. 53

941/1046

24

BKS
NETWORKS

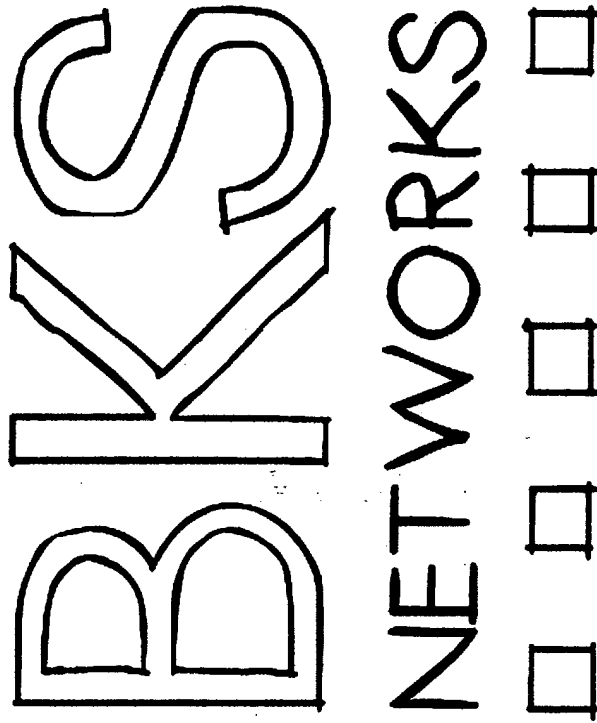

FIG. 53A

942/1046

**The Dilemma in Today's E-Commerce
Brand Marketing Communications Environment**

Brandkey Systems Network

FIG. 53B1

Every day, consumers search for products and services that will satisfy their needs and desires.

943 / 1046

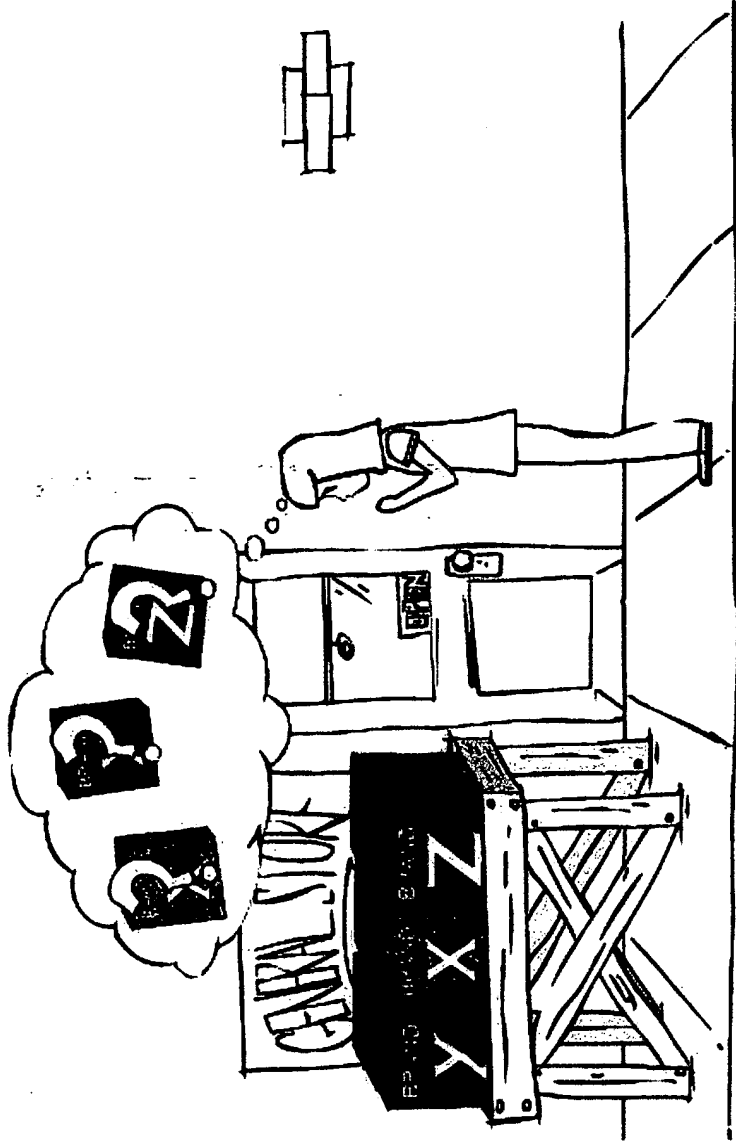

Fig. 53B2

During the search, they are confronted with decisions about which brand of a product or service they should purchase.

944/1046

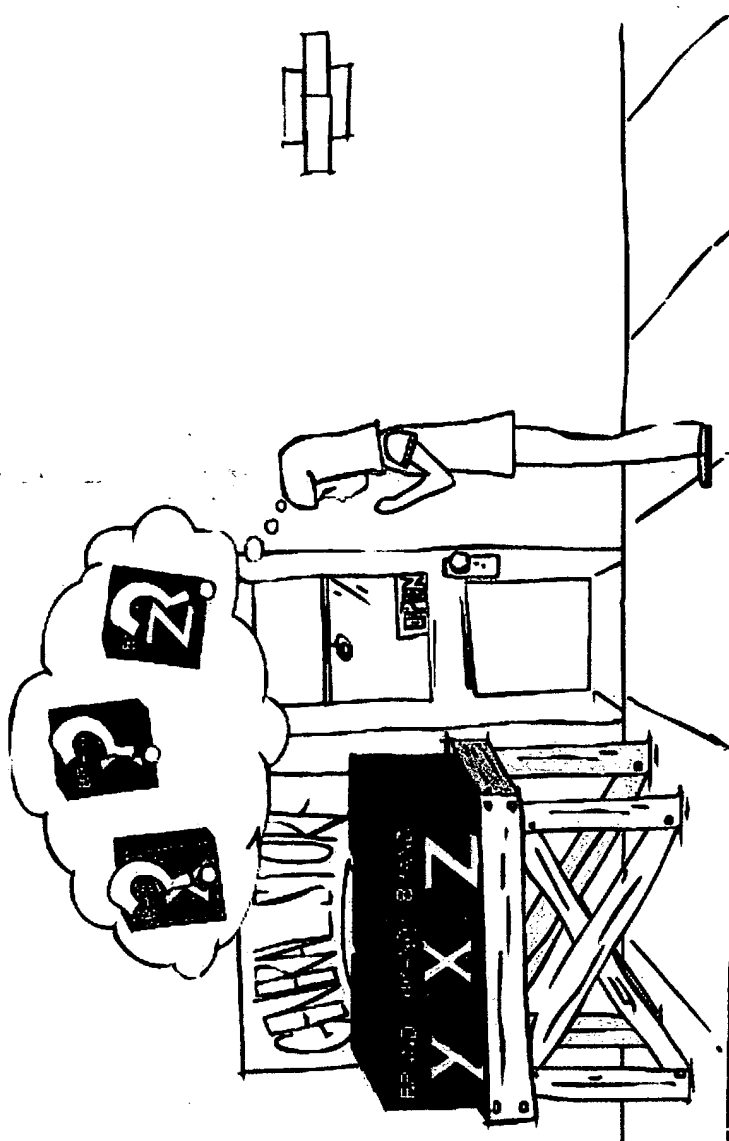

FIG. 53B3

948/1046

Although shopping online eliminates the need for people to travel from store to store, the Internet hasn't made buying decisions any easier for the consumer.

If anything, the Internet makes buying decisions harder for consumers who don't already know which brand they want to purchase.

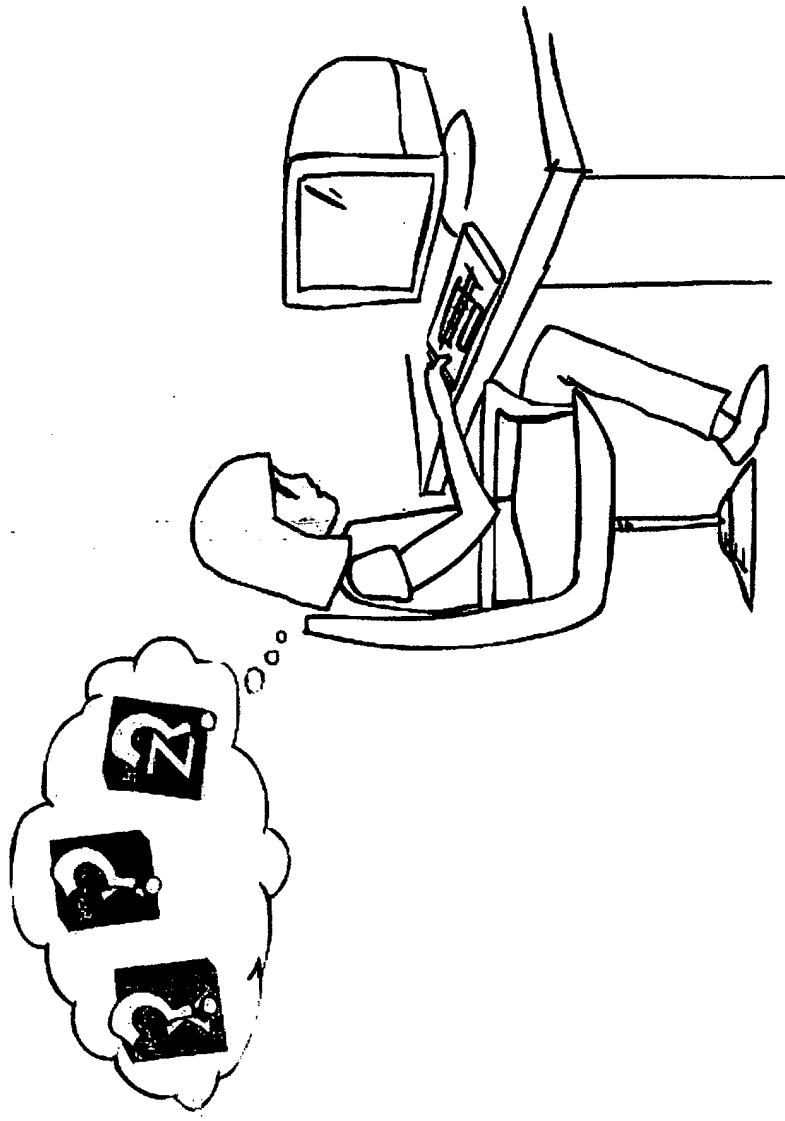

Fig. 53B4

946/1046

Consumers typically shop for brands through e-commerce sites. These sites typically bombard shoppers with every possible brand of a product or service they can purchase.

Because consumers can't touch, test and experience online products, they often need more information prior to purchase decisions -- especially when they don't know anything about a brand...

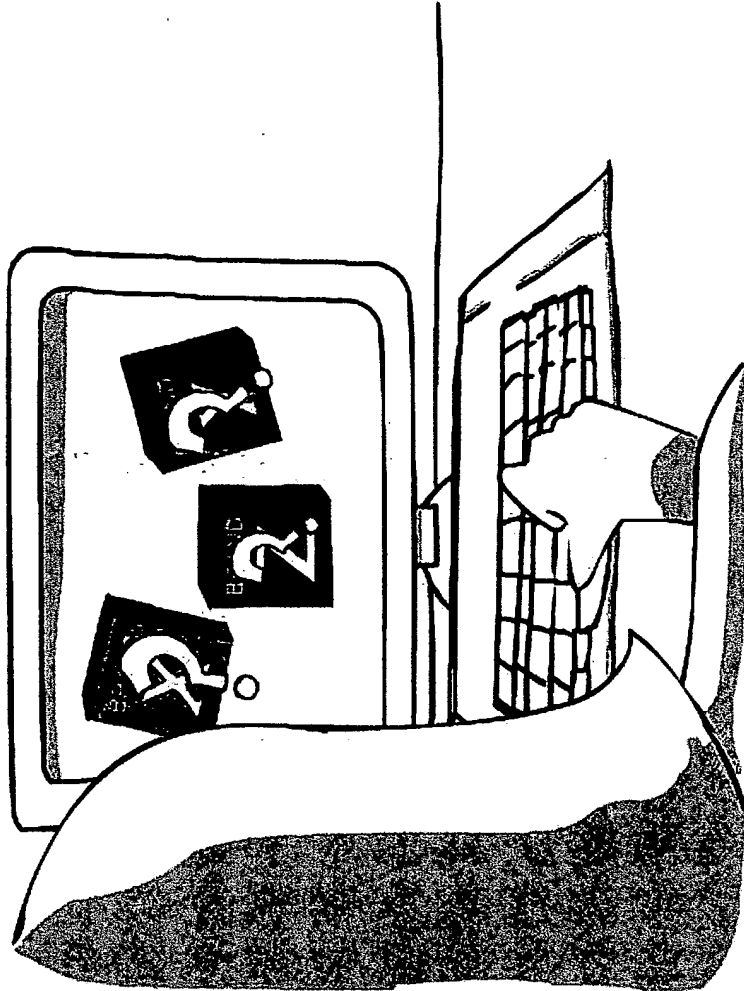

FIG. 5385

947/1046

...but when they search for information on these sites that will help them decide which brand to buy, brand-building information is not readily available.

In fact, most brand information intended to inform and entice the consumer is scattered throughout the World Wide Web.

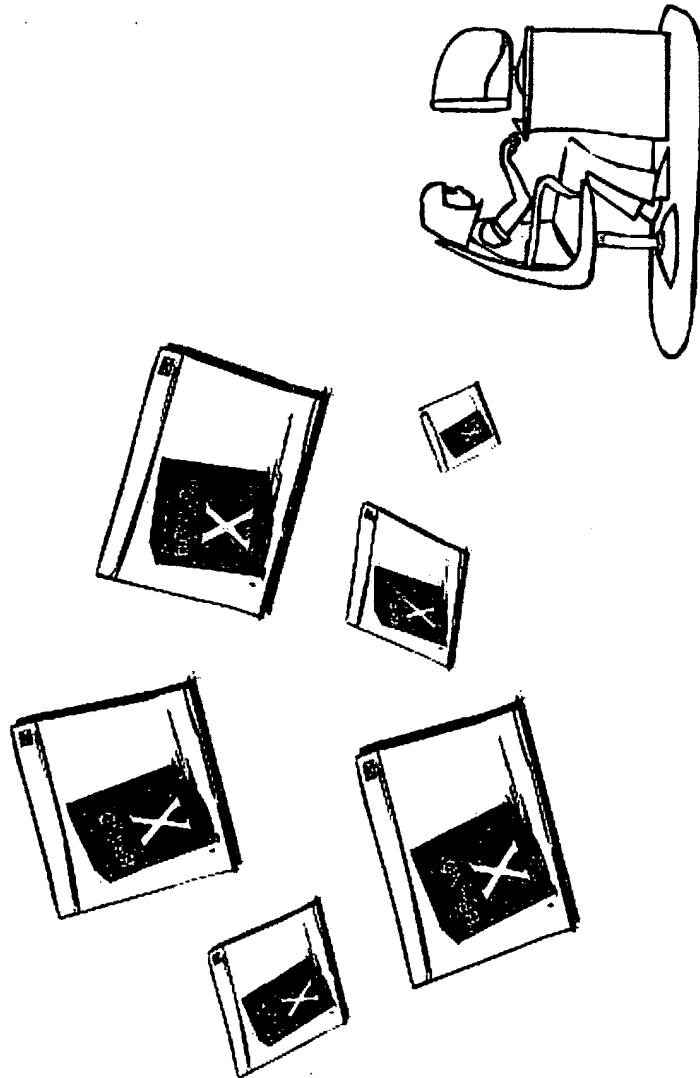
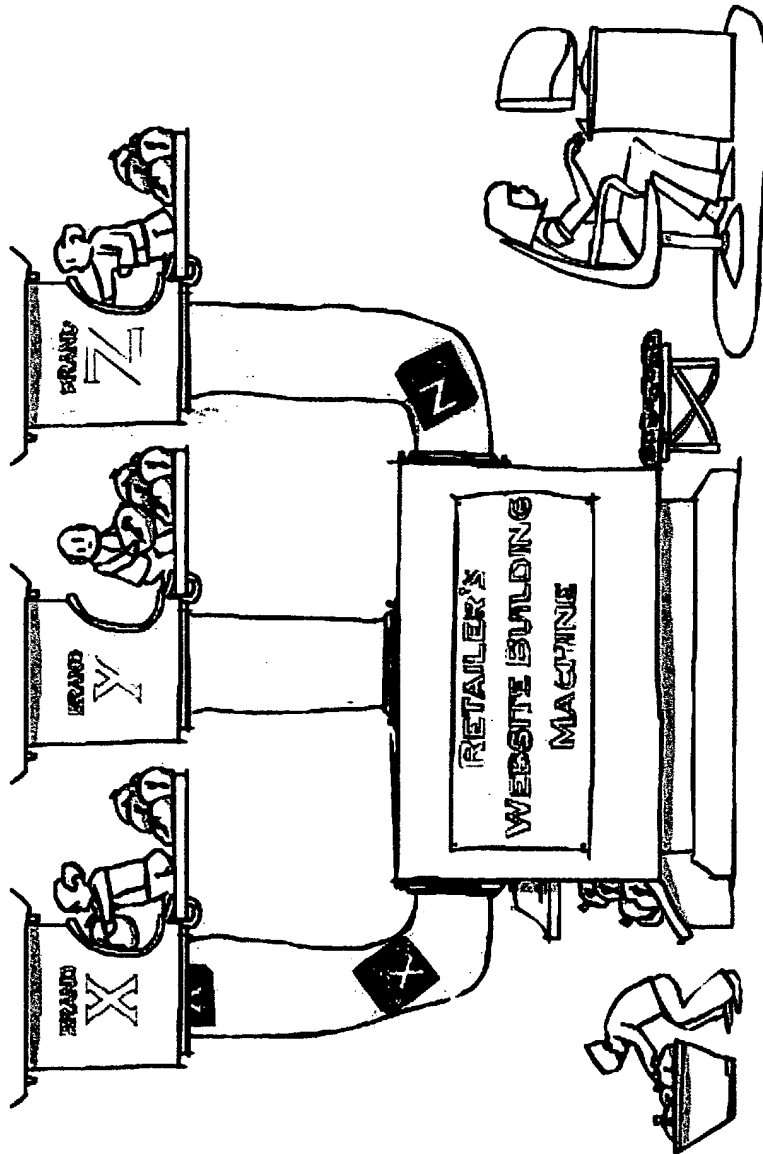

Fig. 53B6

48

E-Commerce sites usually arrange and place the amount of brand information a consumer will encounter on the site.

At best, the consumer gets only product features on these sites - a one-dimensional view of the brand that does little to build an attachment in the mind of the consumer.



2

Fig. 5387

949/1046

With so many brands being funneled through one site in this limited way, not only do brands begin to blur together in the consumer's mind, but the brands may compete with the e-retailer's brand image as well.

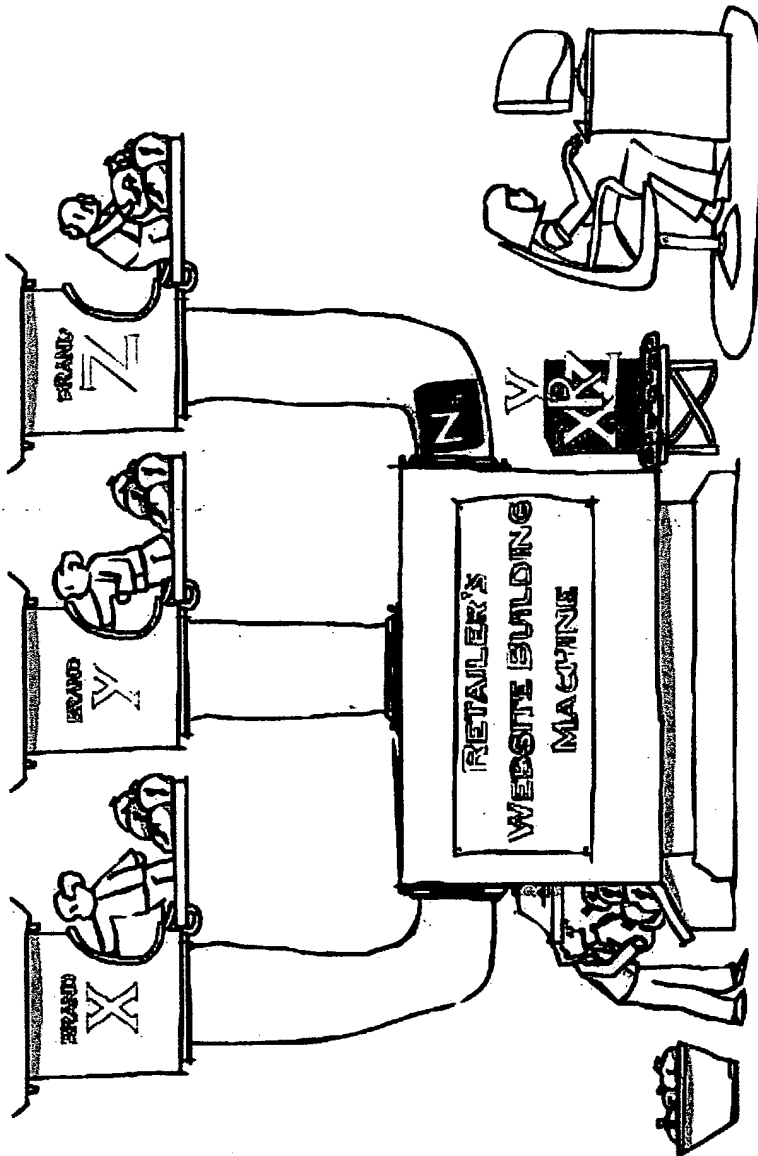

Fig. 5388

950/1040

When the consumer is trying to make a buying decision, valuable brand-building information is unavailable at strategic places such as the checkout.

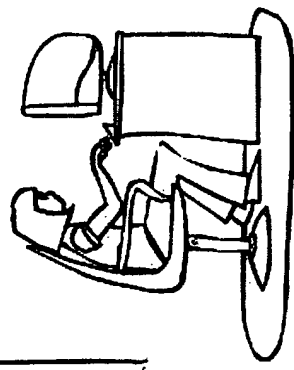
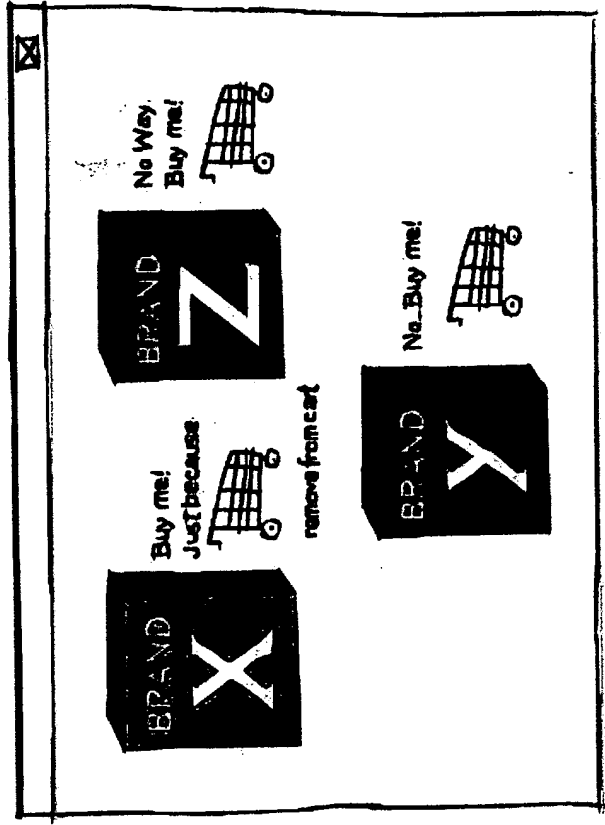

FIG. 53B9

951/1046

Often, the lack of valuable brand-building information leads to abandoned shopping carts as consumers wander about the Internet looking for this decision-critical information.

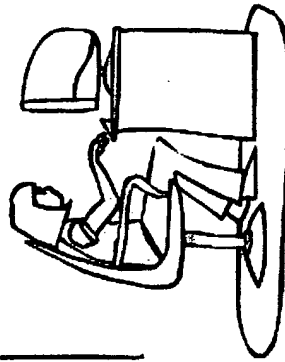
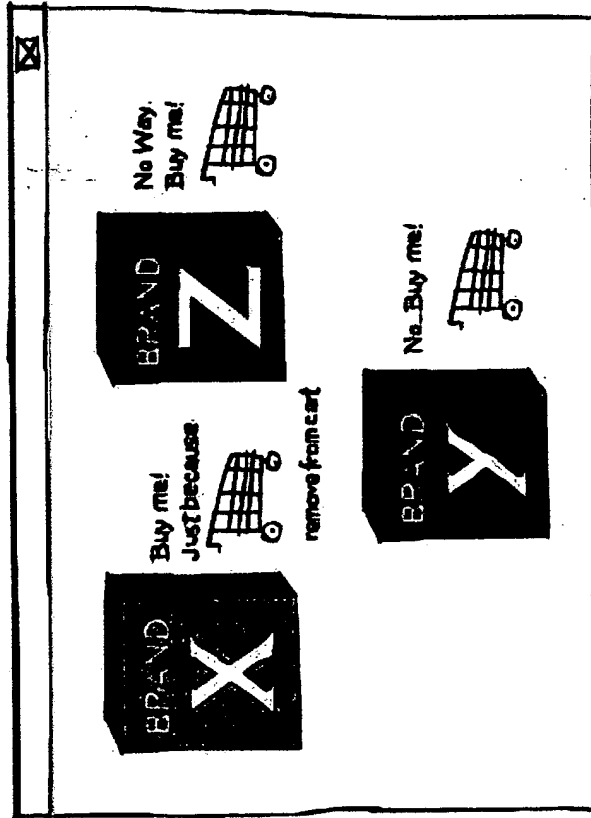

FIG. 53B10

Consumers may even find a brand's own website difficult to navigate when they need to quickly locate promotional and other desired brand-building information.

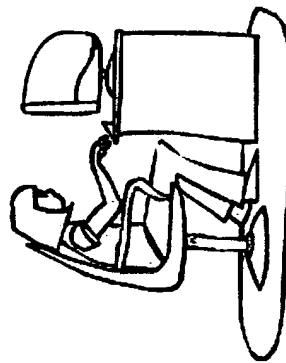
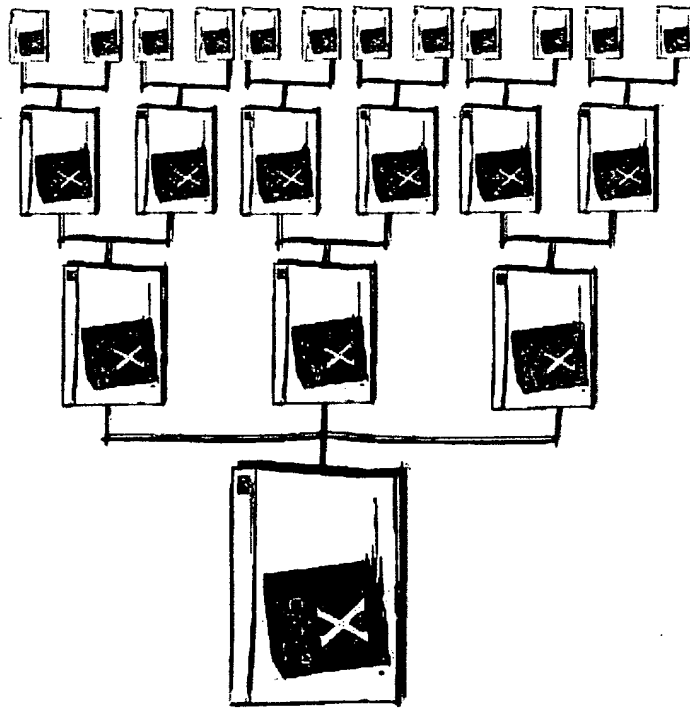

FIG. 53811

953/1046

Current methods which brand managers use to communicate brand-building information on the web are also not reaching the consumer.

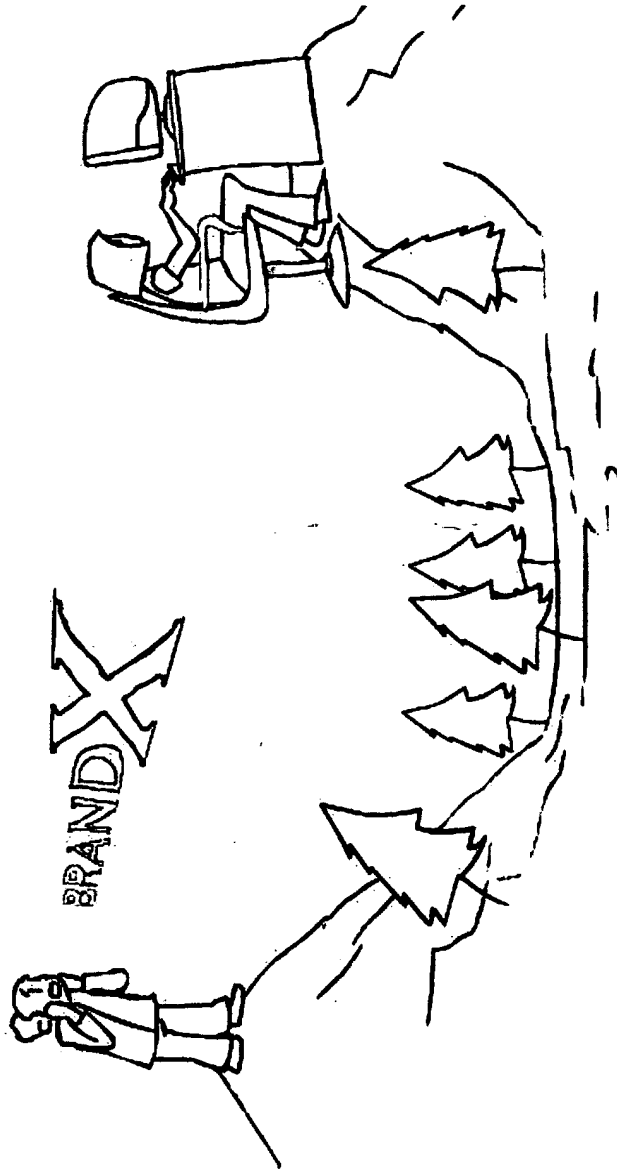
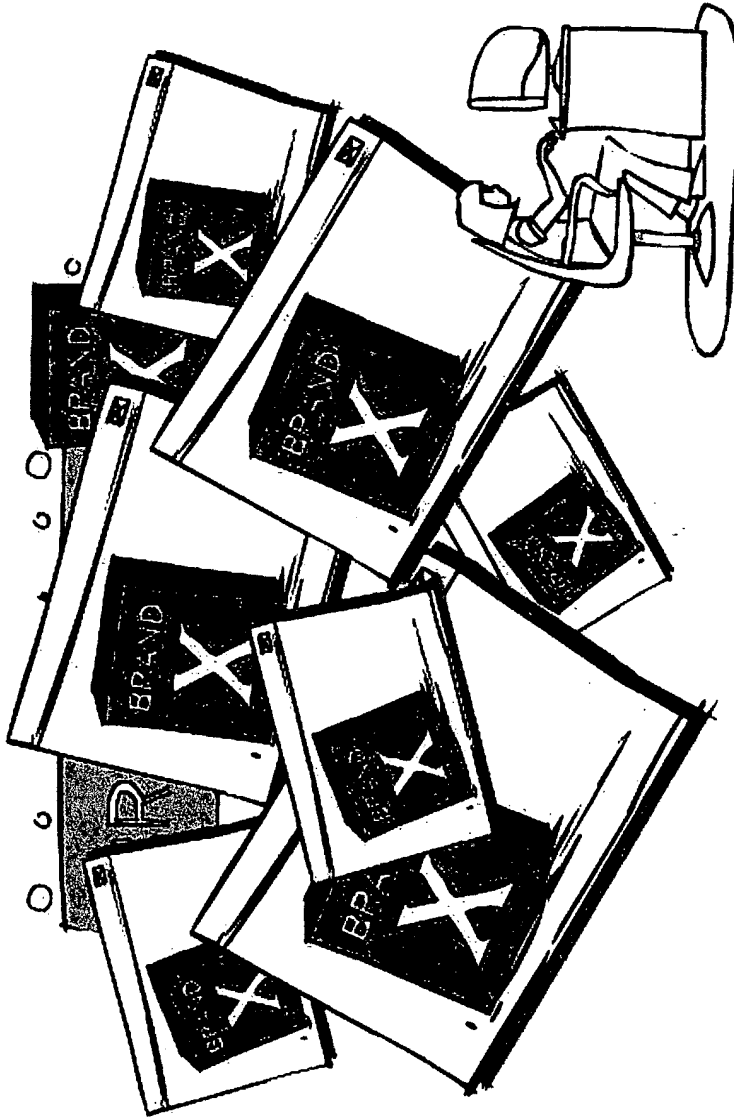

FIG. 53B12

954/1046

Brand managers currently favor banner and pop-up ads and promos. These ads rarely succeed in building accurate brand images in the minds of consumers . . .



42

FIG. 53B/3

955/1046

...because they create a warlike atmosphere on the consumers desktop with brand managers advertising and promotional agents all battling for the consumer's attention and valuable screen space.

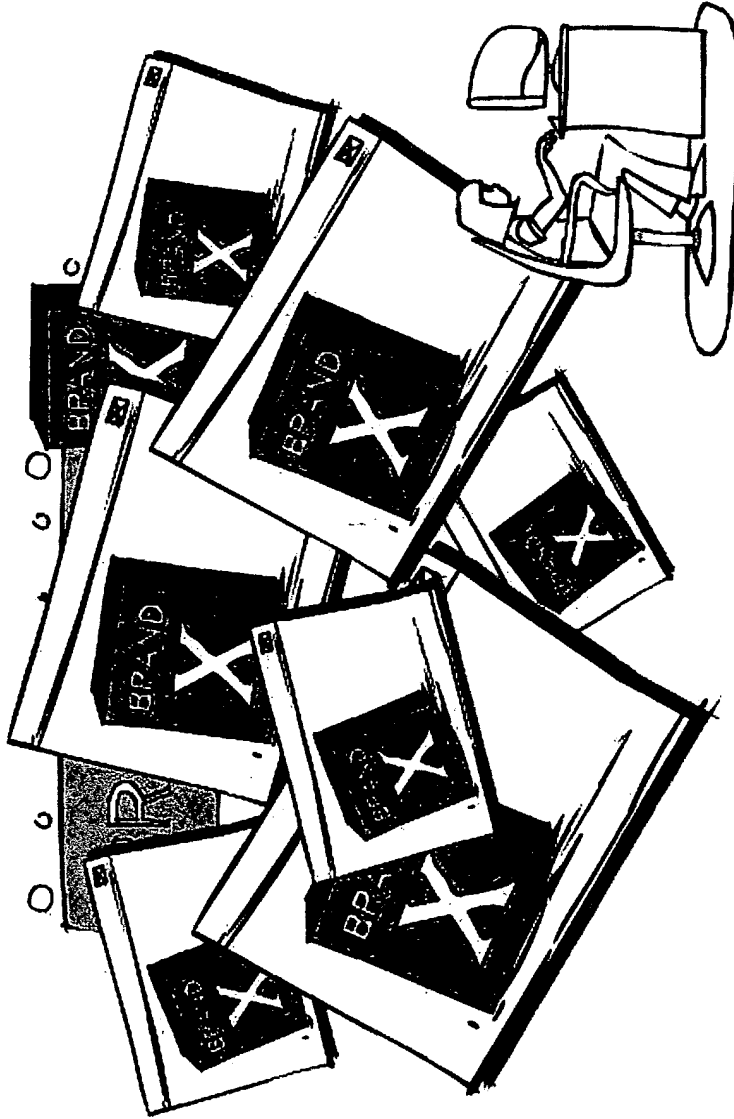

FIG. 53B14

956/1046

The online advertising and promotion battle has intensified recently after ads and promos began using technology that makes them harder for the consumer to turn off.

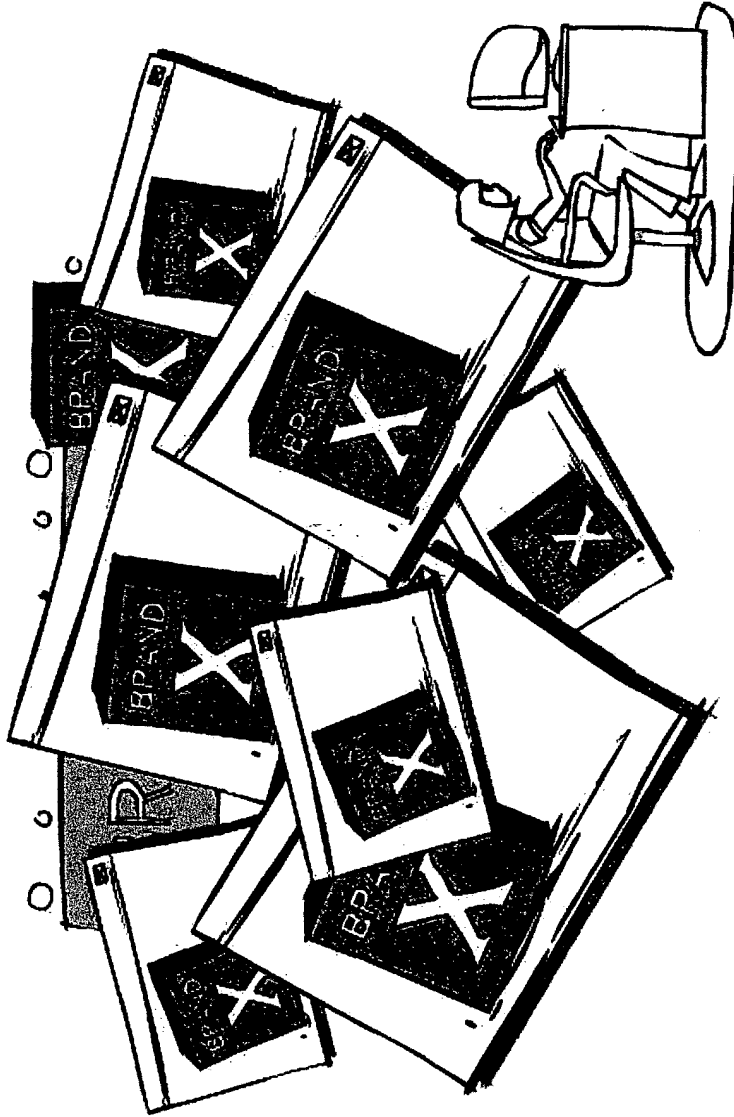

FIG. 53B15

AA

957/1046

Online ads and promos have only alienated consumers from the brands these ads and promos represent, and from the entire Internet experience.

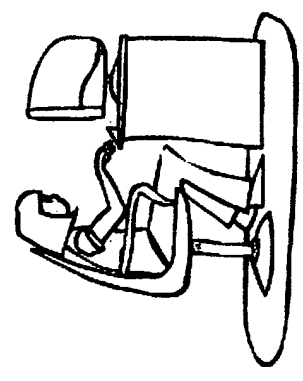
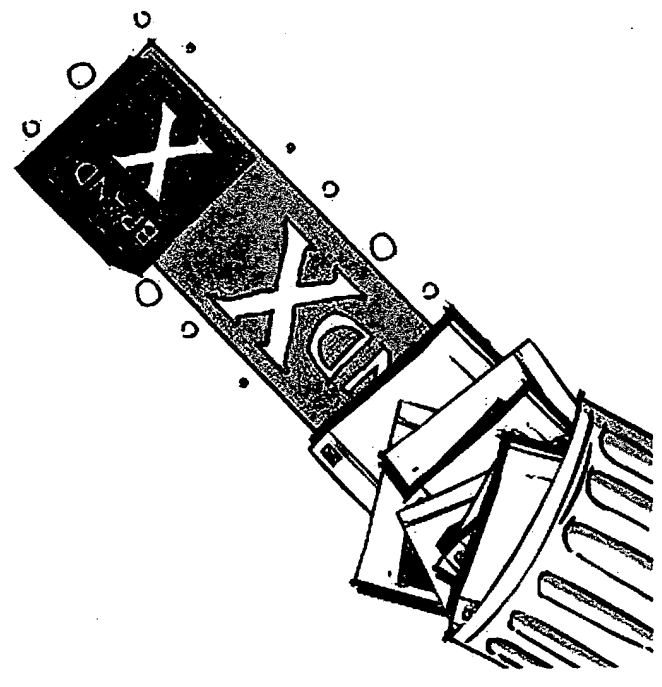

FIG. 53B16

958/1046

Ultimately, consumers fail to form the brand image intended by the brand management team.

Sometimes, consumers may even form radically different impressions of the brand in their minds.

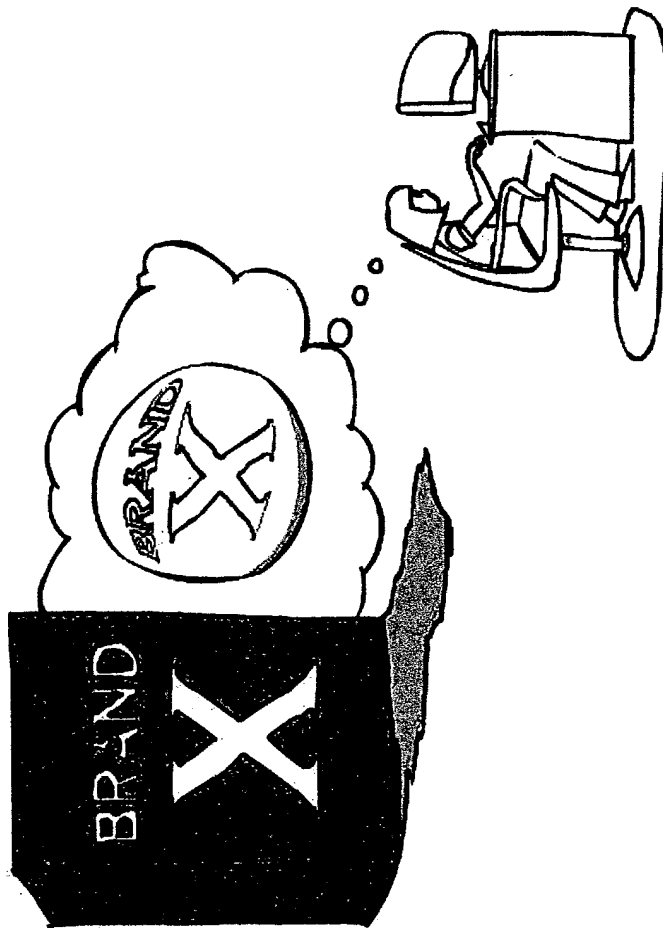

FIG. 53B17

The burden of brand marketing communications remains with traditional media tools such as television, radio, and print...

... and brand managers do not leverage the tremendous potential of the Internet to interact with consumers and build their brands and their businesses.

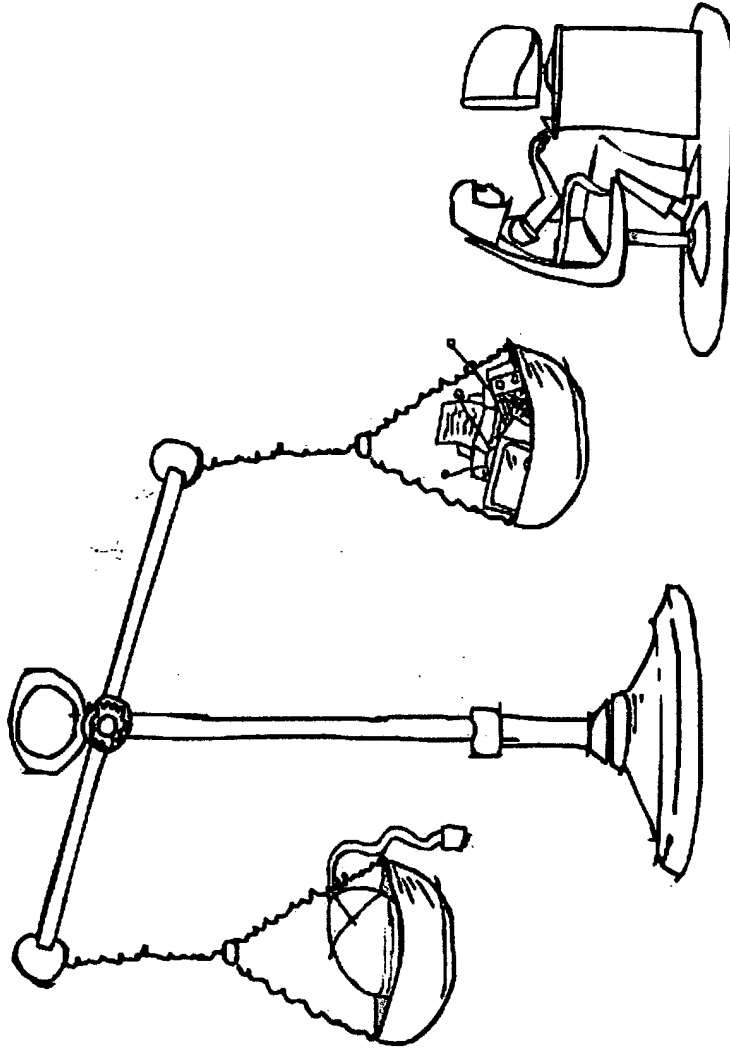
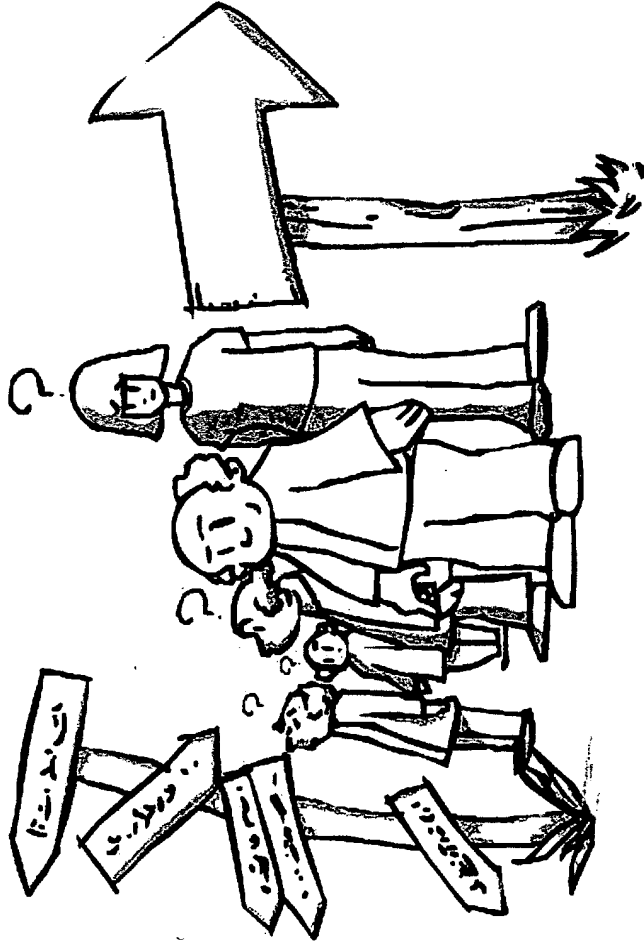

FIG. 53 B18

Despite so many frustrating and annoying online shopping experiences, consumers still want to shop online.

But they want changes in the e-commerce marketplace.



960/1046

FIG. 53B19

961/1046

Brand managers need a far more effective way of delivering their brand building information to the consumer online.

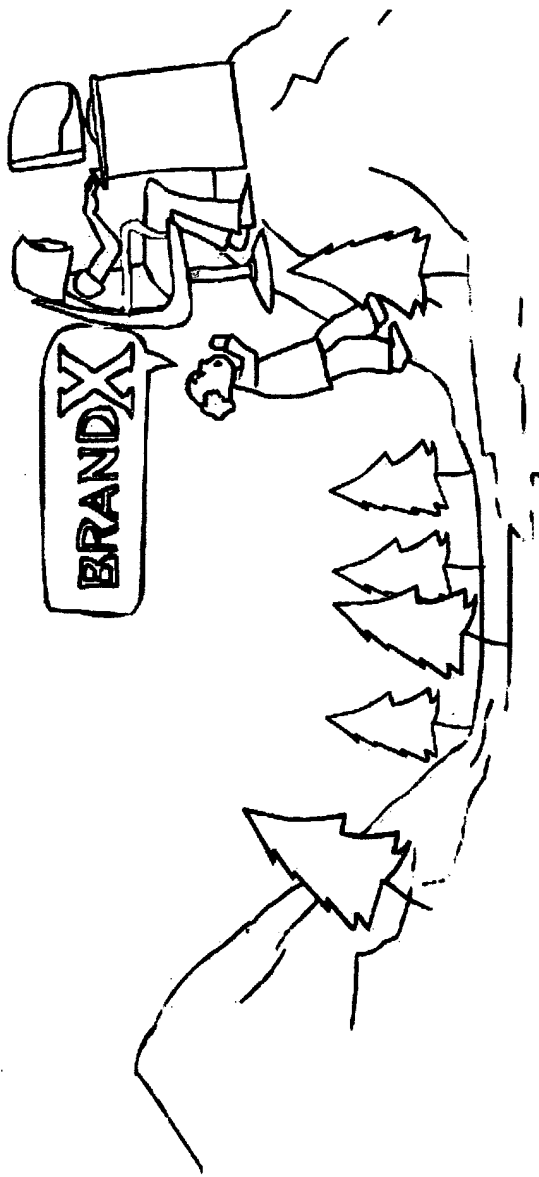

FIG. 53B20

962/1046

The Brandkey Solution

FIG. 53C

963/1044

Brandkey Systems Network is a powerful tool for brand managers. It captures the brand- building information currently scattered throughout the Web and places it at critical touch points where -- and when-- the consumer is considering a purchase on the Web.

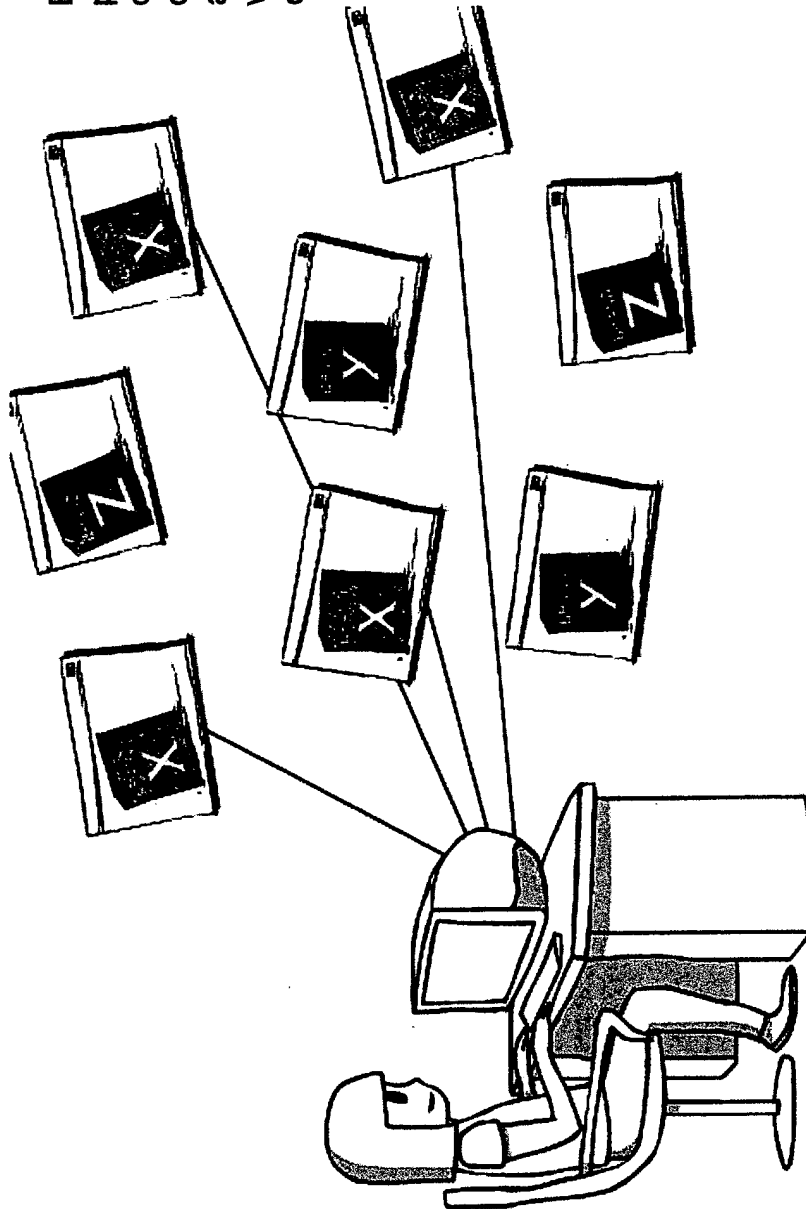

FIG. 53C1

964/1046

Whether they're at Checkout on an e-commerce site, walking down the street on cell phones or dispensing cash at an ATM machine... consumers can instantly watch your ad, find out about the latest promotions, gain detailed product information, search the store locator or find other information through something called Brandkey's Multi-Mode Virtual Kiosk.

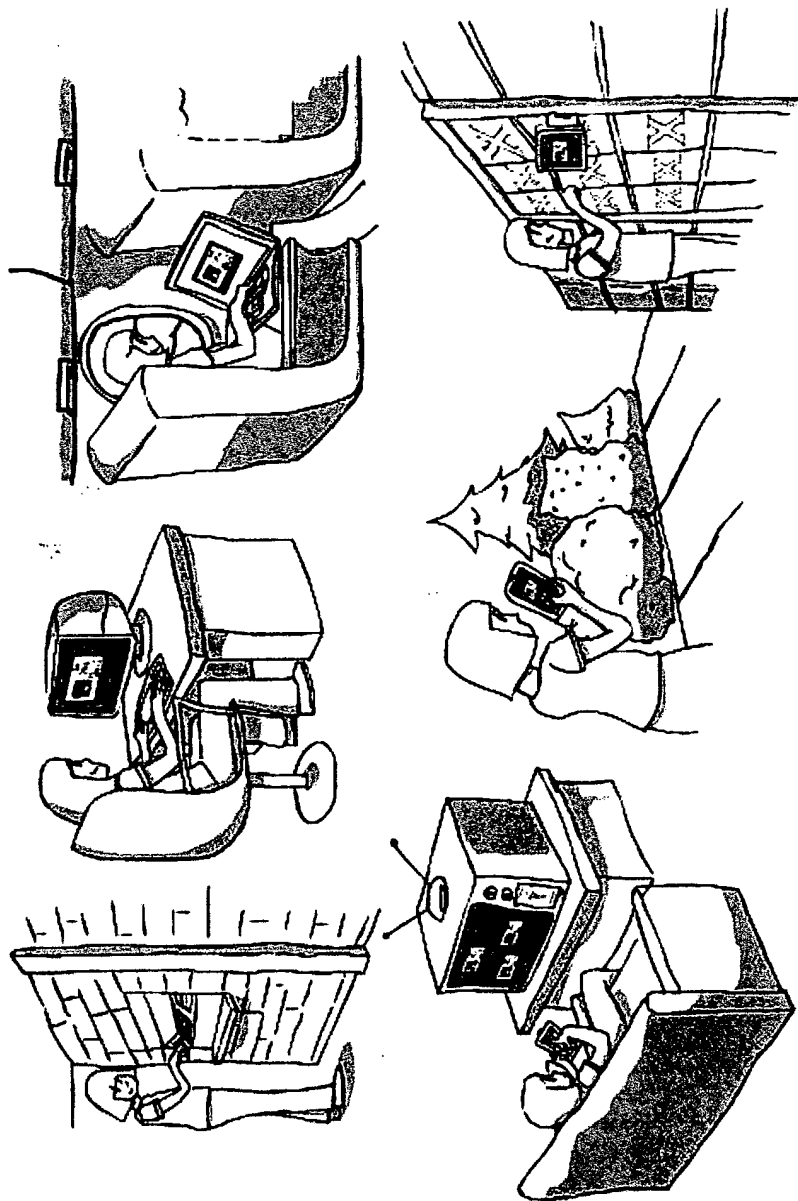

FIG. 53C2

965/1046

**Brandkey Systems
Multi-Mode Virtual Kiosks**

allow brand managers to quickly communicate a brand through three programmable display modes:

- Advertising Display Mode
- Promotional Display Mode
- Brand Information Network Display Mode

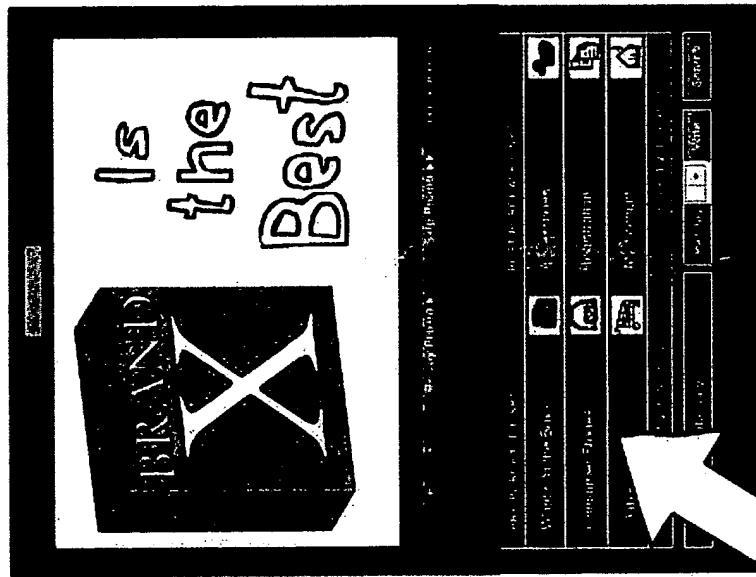

fig. 53C3

966/1046

In seconds, consumers can obtain a multi-dimensional experience of a branded product or service...

without the influence of other brands.

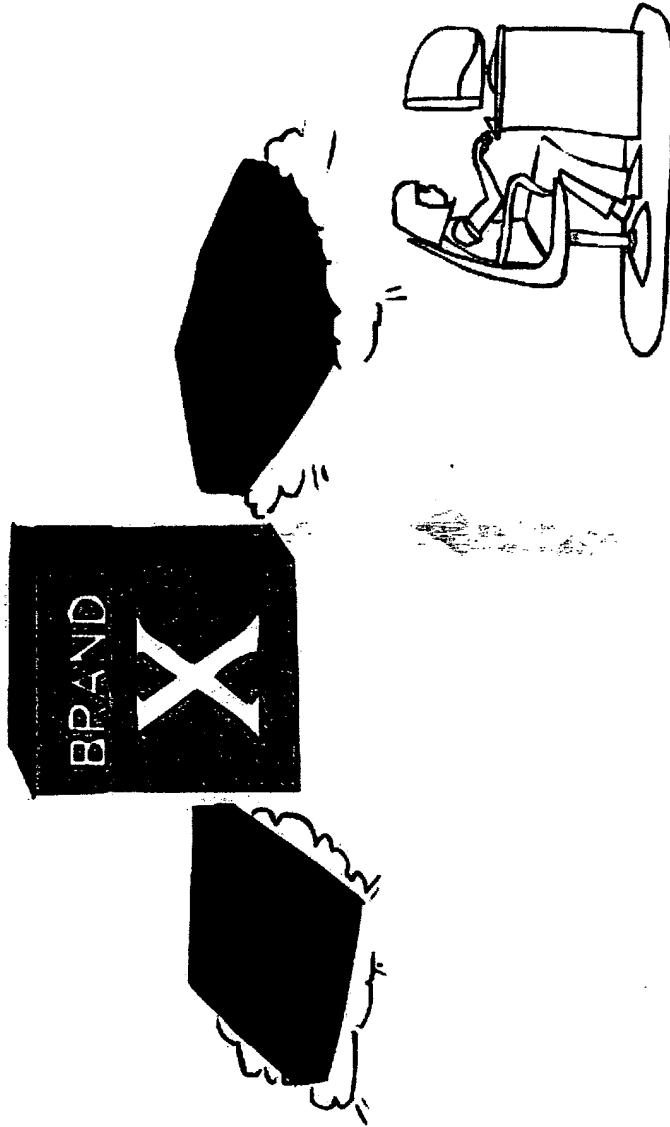

FIG. 53C4

967/1046

~~5~~

And consumers no longer
need to wander off to other
websites in search of brand-
related information.

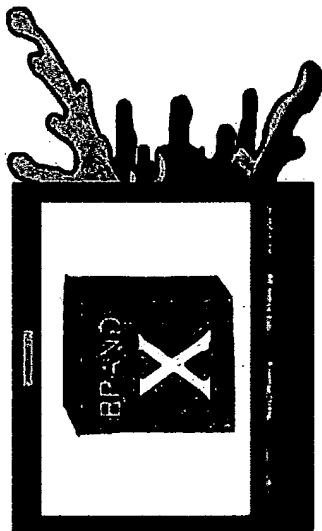
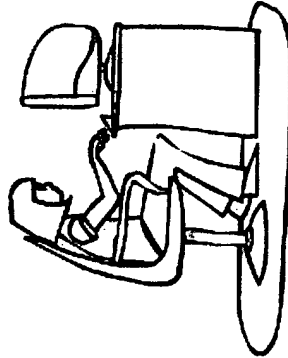
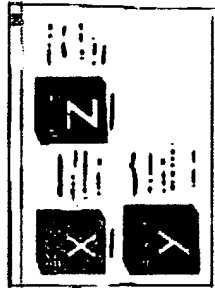

FIG. 5305

968/1046

Using Brandkey's Multi-Mode Virtual Kiosks, brand management teams can even communicate to consumers through e-commerce sites operated by others - confident that consumers will experience their brands consistently and develop brand images that are aligned with their marketing objectives.

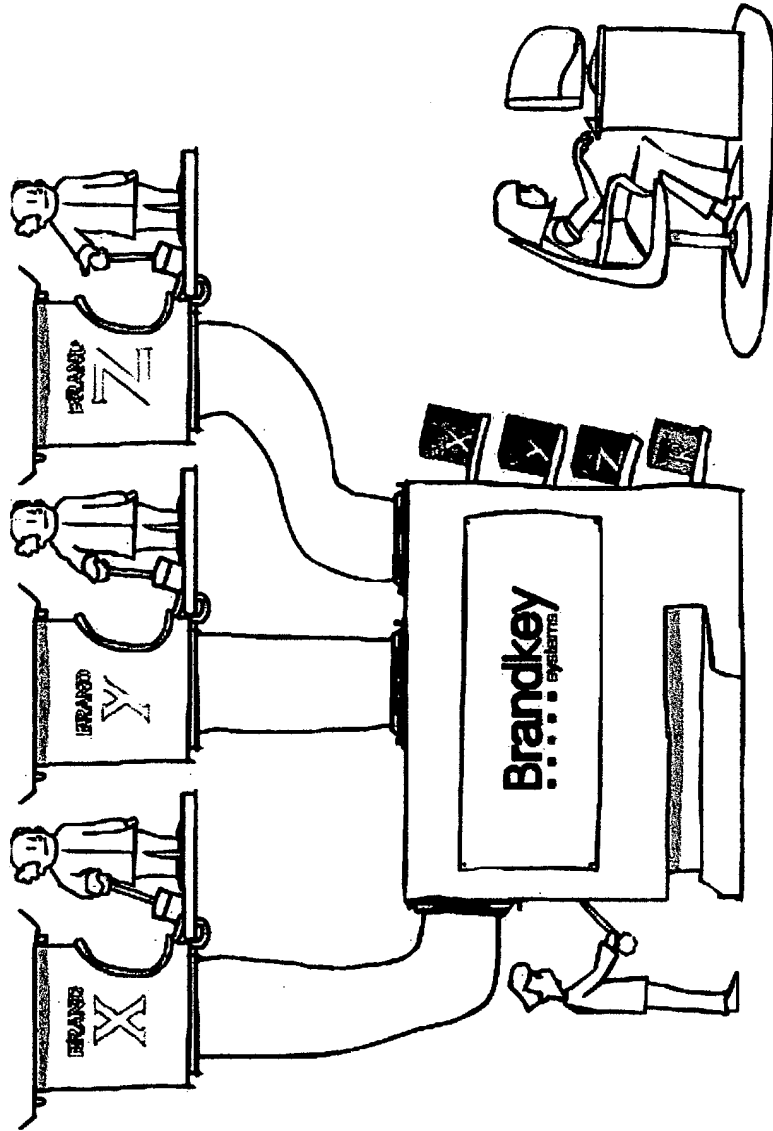

FIG. 5306

969/1046

The Brandkey Systems
Network enables brand
management teams of
any size and
arrangement to rise
above the clutter in the
Internet marketplace

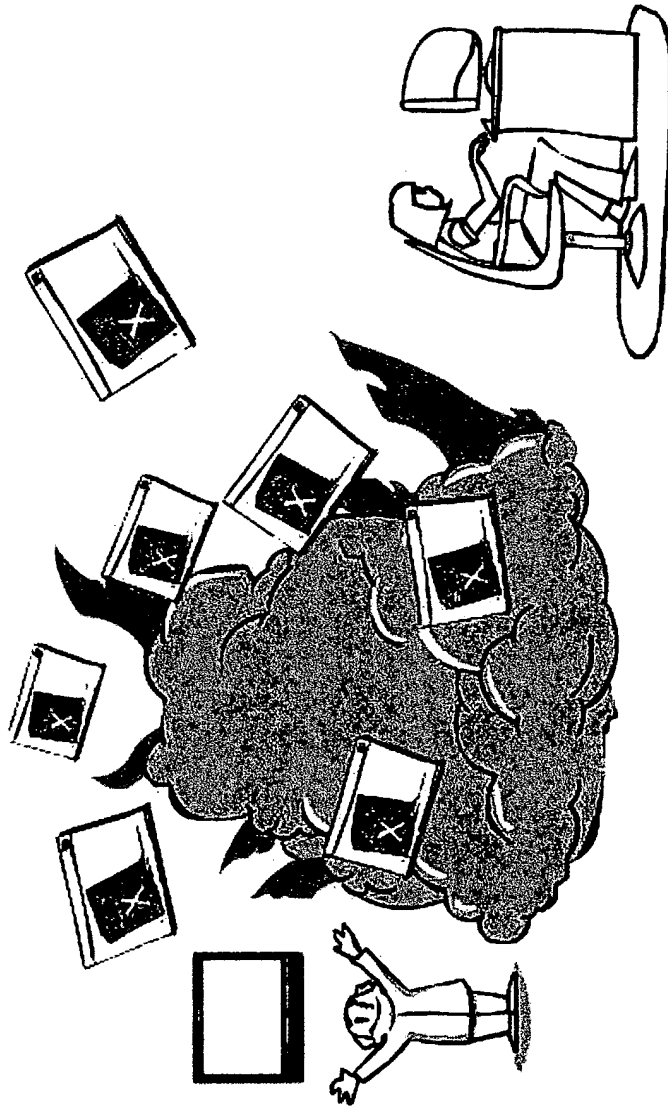

Fig. 53C7

970/1046

...and communicate the essence
and character of their brands
directly to the consumer.

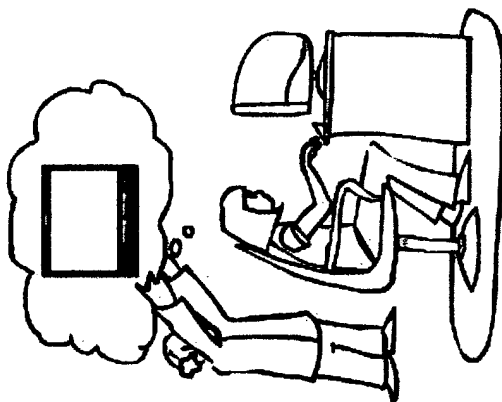

Fig. 5308

~~VA~~

971/1046

Building Your Own BKS Network

FIG. 53 D 1

972/1046

Each ad, promotion or other brand building resource you place on the web has a unique address on the World Wide Web specified by a Uniform Resource Locator or URL.

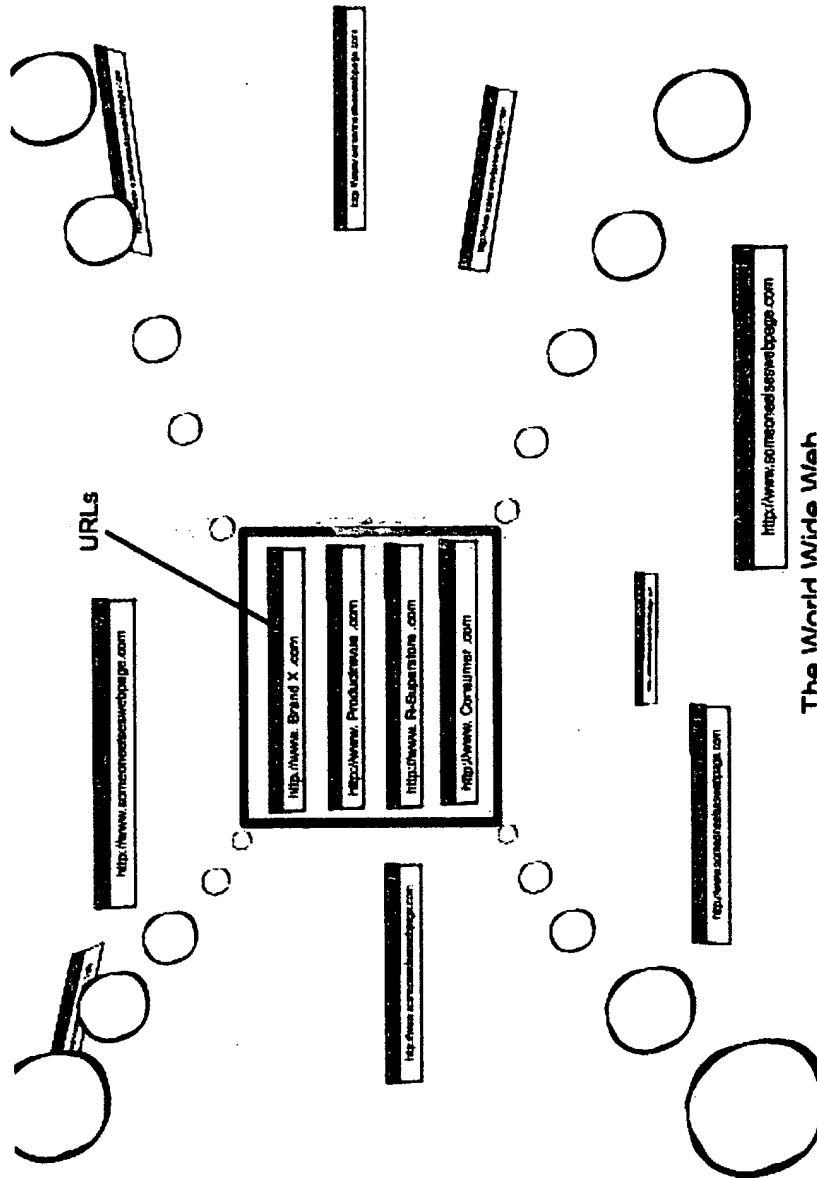

Fig. 53D2

973 / 1046

Each of your products has three unique identifiers: a Trademark, a Universal Product Number (UPN) and a Product Descriptor.

Together, they form a Product Data String.

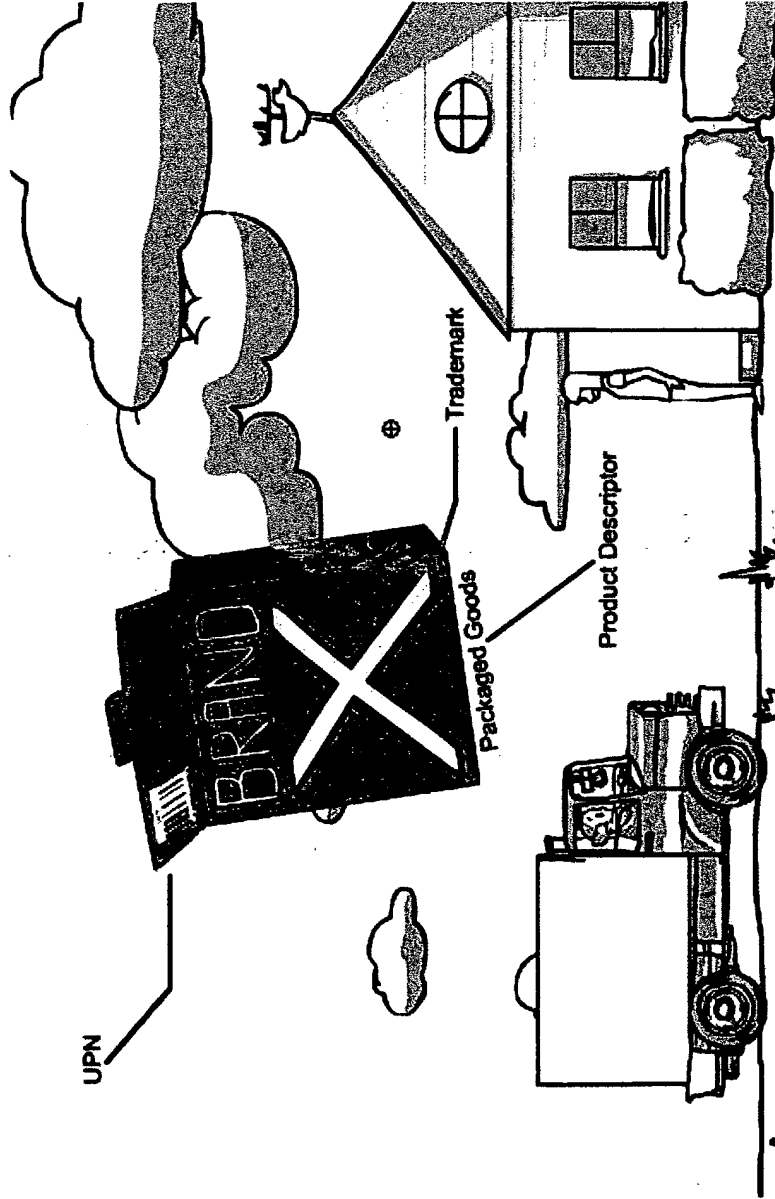

FIG. 53D3

Branded services also have three unique identifiers: a Universal Service Number (USN), a Service Mark (SM) and a Service Descriptor (SD).

Together, they form a Service Data String.

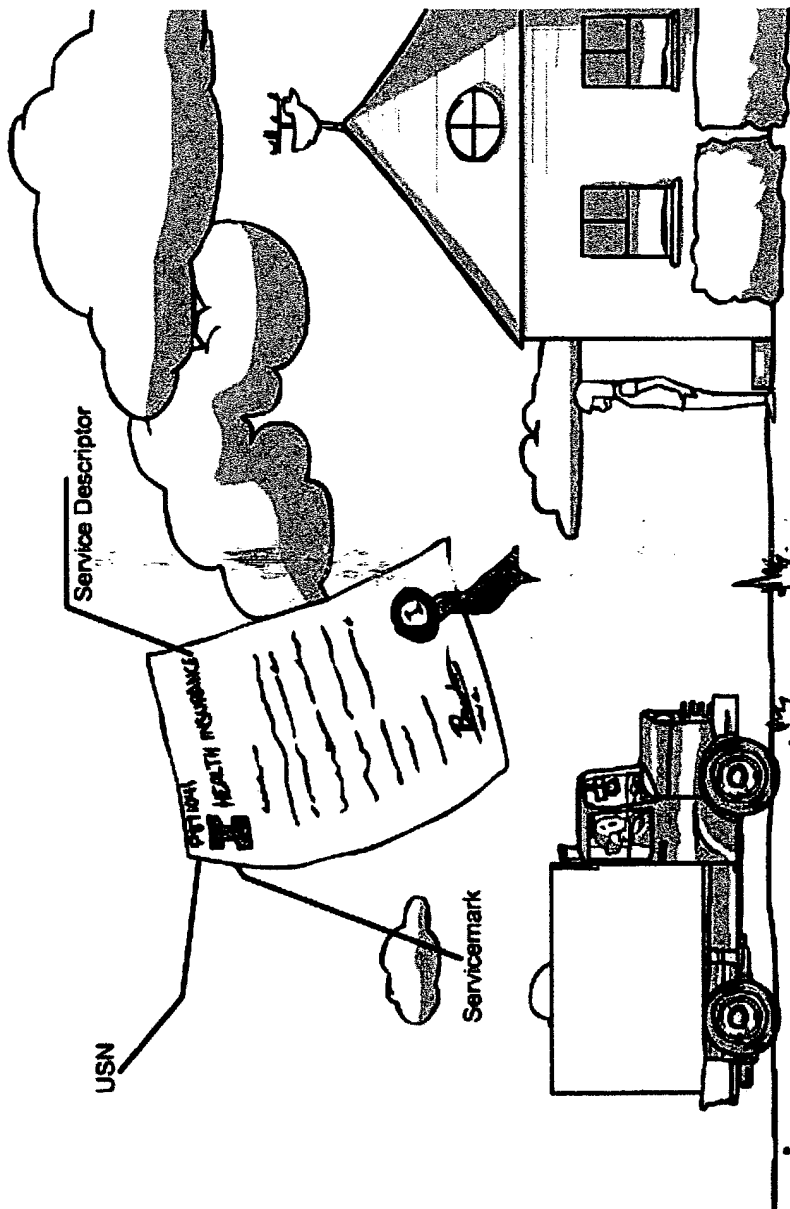

Fig. 53D4

975/1046

Brandkey's revolutionary network
enables you to attach the
Uniform Resource Locators (or
URLs) of your brand-building
resources on the Web, to these
Product or Service Data Strings.

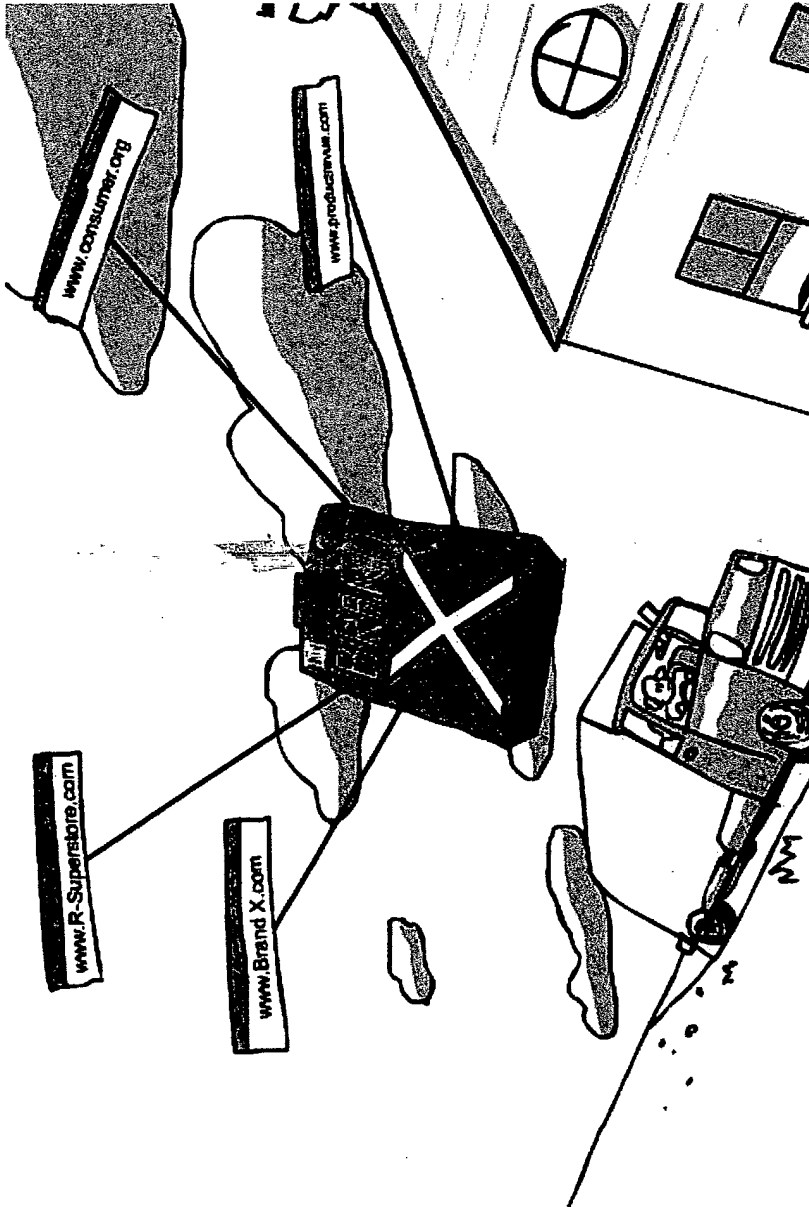
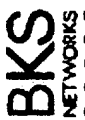

Fig. 53D5

976/1046



Brandkey Systems

Brandkey Course

Brandkey Advisor

Brandkey Advertiser

Brandkey Promote

Brand Management and Marketing Communication Network

You can easily create, deploy, modify and manage a Multi-Mode Virtual Kiosk at your own computer, using the following five network components...

FIG. 53D6

977/1046

Brandkey Systems enables you to track and manage the users and brands on your Multi-Mode Virtual Kiosks.

Brand Management and Marketing Communication Network



- Brandkey Systems
- Brandkey Create
- Brandkey Deploy
- Brandkey Advertise
- Brandkey Promote

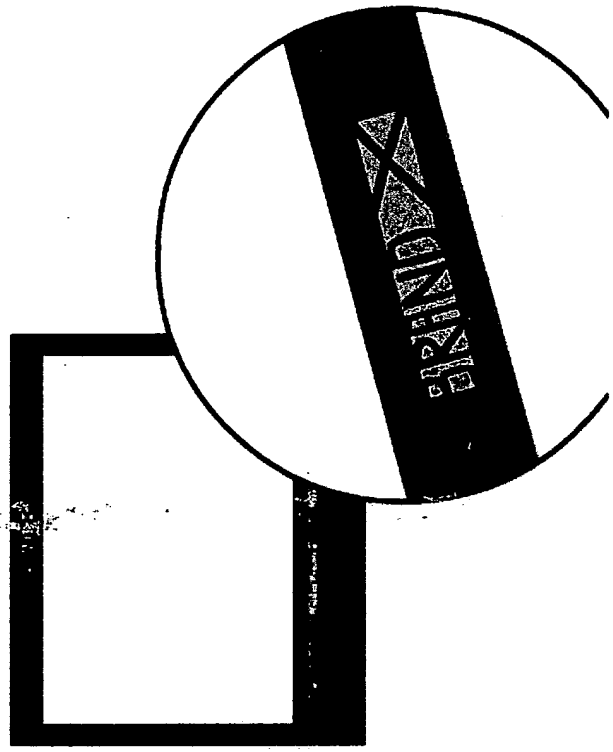
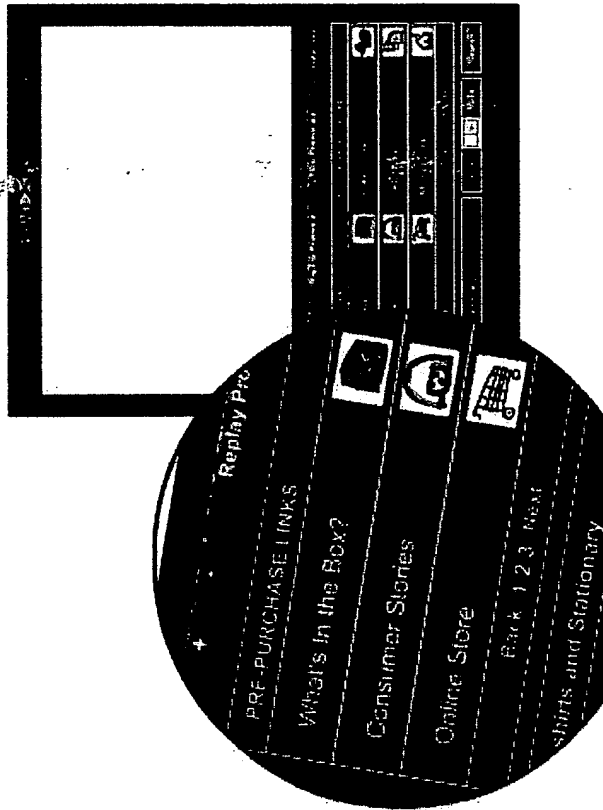

Fig. 53D7



Brand Management and Marketing Communication Network

Brandkey Systems | Brandkey Create | Brandkey Control | Brandkey Advertising | Brandkey Promotion



In Brandkey Create, you select the links that consumers will see in the Ad, Promo or Brand Information Network Display modes.

978/1046

FIG. 53D8

979/1046



Brand Management and Marketing Communication Network

- Brandkey Systems
- Brandkey Cruise
- Brandkey Deliver
- Brandkey Awards
- Brandkey Promote

Brandkey Deliver is the place where you actually set the kiosk in motion. In a few simple steps, you can create, deploy and install the kiosk.

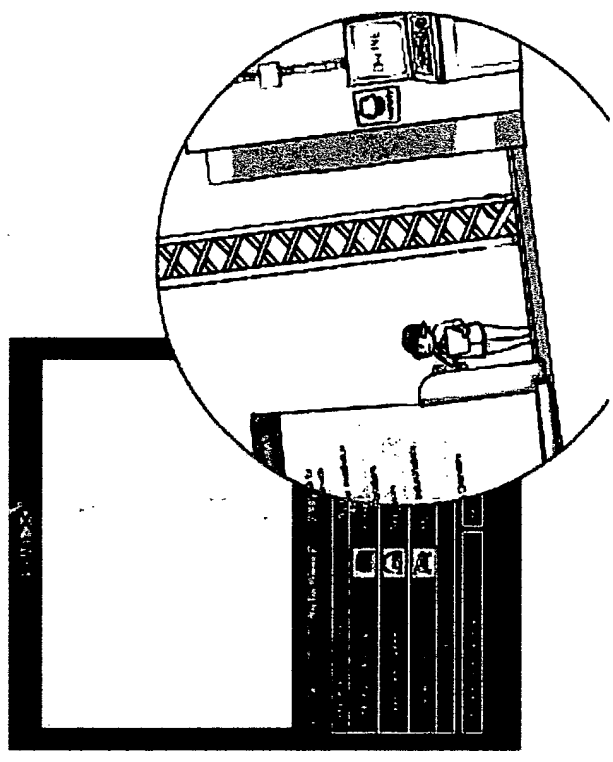

fig. 53D9

980/1046

Brandkey Advertise and Brandkey Promote enable you to program and update your ad spots and latest sales promotions on the Web quickly and easily.

Brand Management and Marketing Communication Network

Brandkey
.....promote

Brandkey Systems < Brandkey Create < Brandkey Controls < Brandkey Advertise < Brandkey Promote

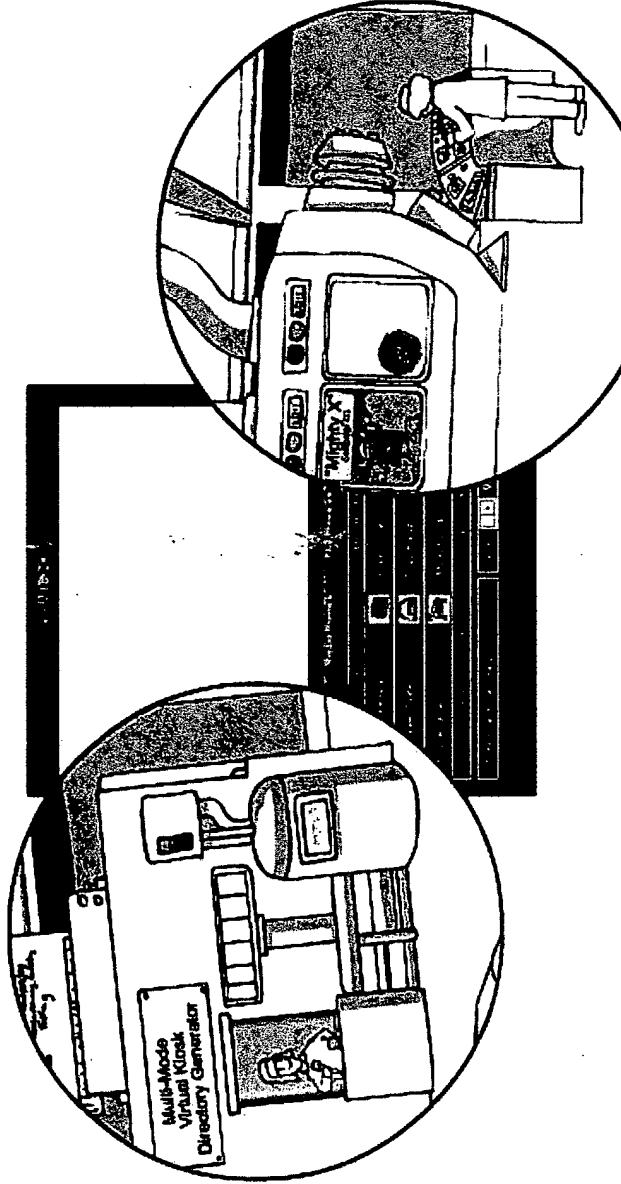

Fig. 53D10



Brand Management and Marketing Communication Network

- ▶ Brandkey Systems
- ▶ Brandkey Create
- ▶ Brandkey Control
- ▶ Brandkey Agent
- ▶ Brandkey Premium
- ▶ Search/Edit User
- ▶ Add New User
- ▶ Update Information
- ▶ Update Services
- ▶ Edit Information
- ▶ View/Edit Privileges
- ▶ Certify Agents
- ▶ View Brand Metrics
- ▶ Registration



Systems enables users to perform a range of management and administration functions.

You decide who can create content for the kiosks.

981/1046

Fig. 53D11

You can track the activities of both team members and outside agents whom you've given the right to place advertising and promotion spots on the Multi-Mode Virtual Kiosks.

You can shut down any display you don't like.

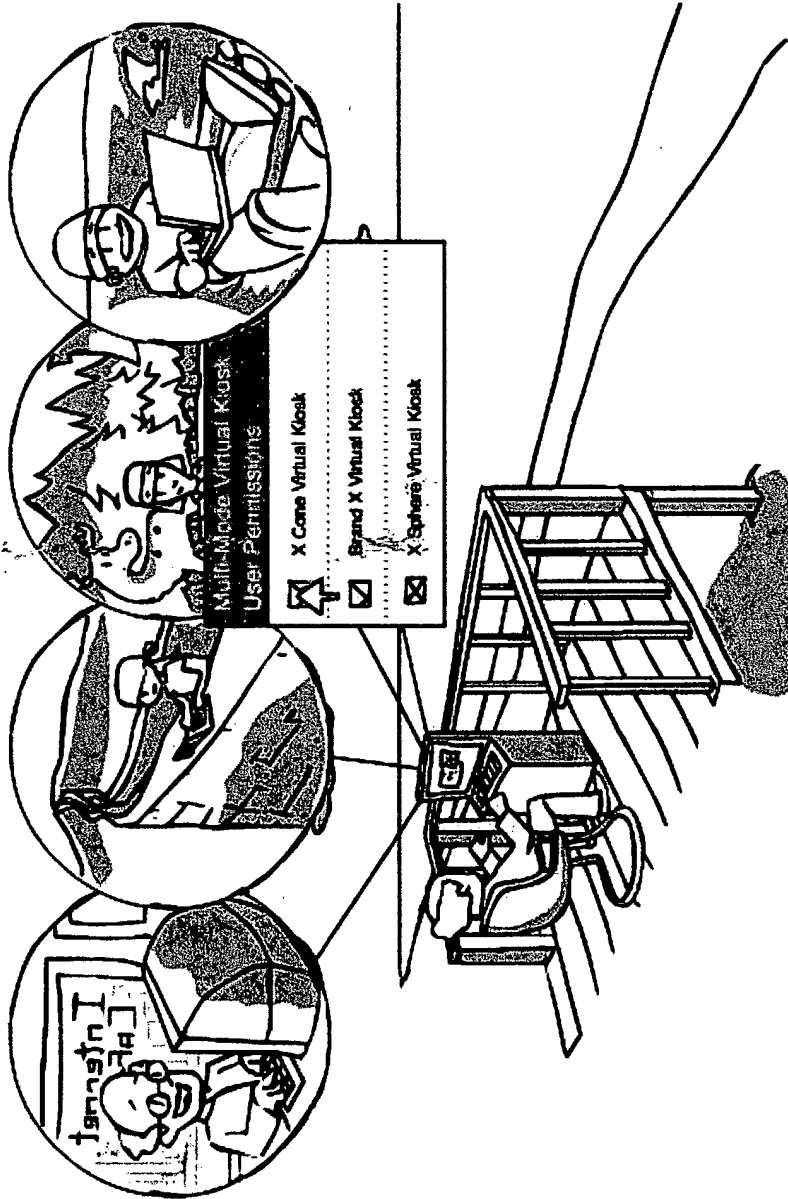

Fig. 53D12

983/1046

In Systems, you can also monitor and measure consumer activity on the kiosks.

You can find out how consumers rated the effectiveness or usefulness of an ad or resource, or identify potential new customers based on who downloads your kiosk.

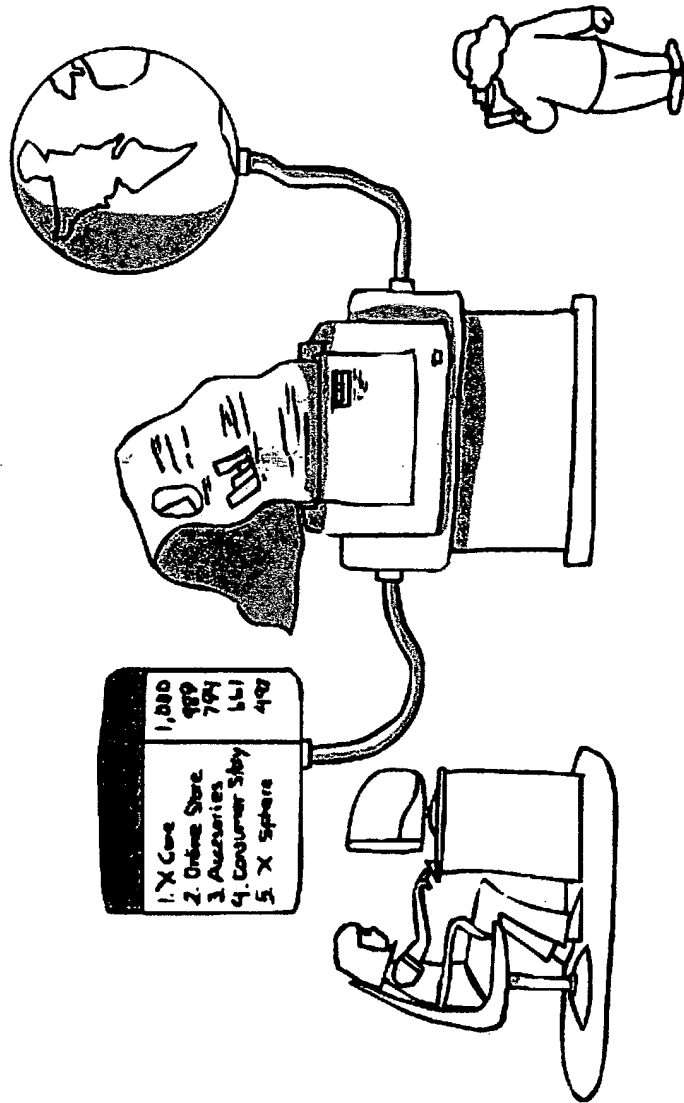

FIG. 53D13

984/1046

Brandkey
create

Brand Management and Marketing Communication Network

- Brandkey Systems
- Brandkey Create
 - Select Brand Logo
 - Configure Control Panel
 - Manage Data Strings
 - Manage Data Links
 - Manage Info Resources
- Brandkey Deliver
- Brandkey Advertise
- Brandkey Promote

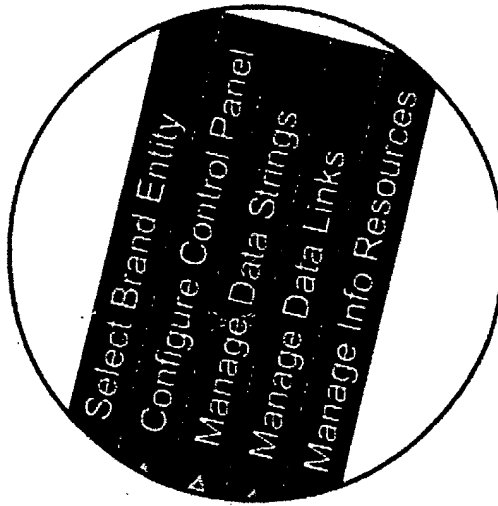

FIG. 53D14

985/1046

You begin by creating a data string for your brand by entering the UPN or USN, trademark and product descriptor...

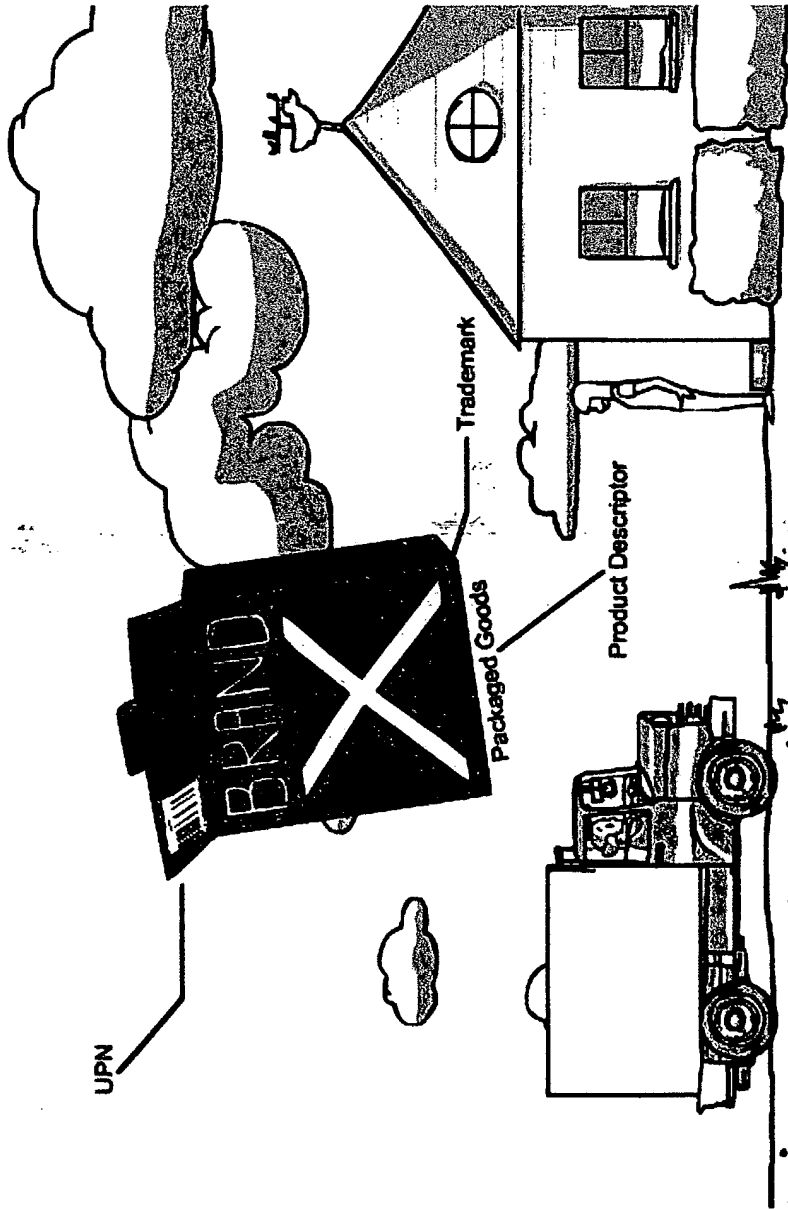

FIG. 53D15

986/1046

You can enter this information manually or ...

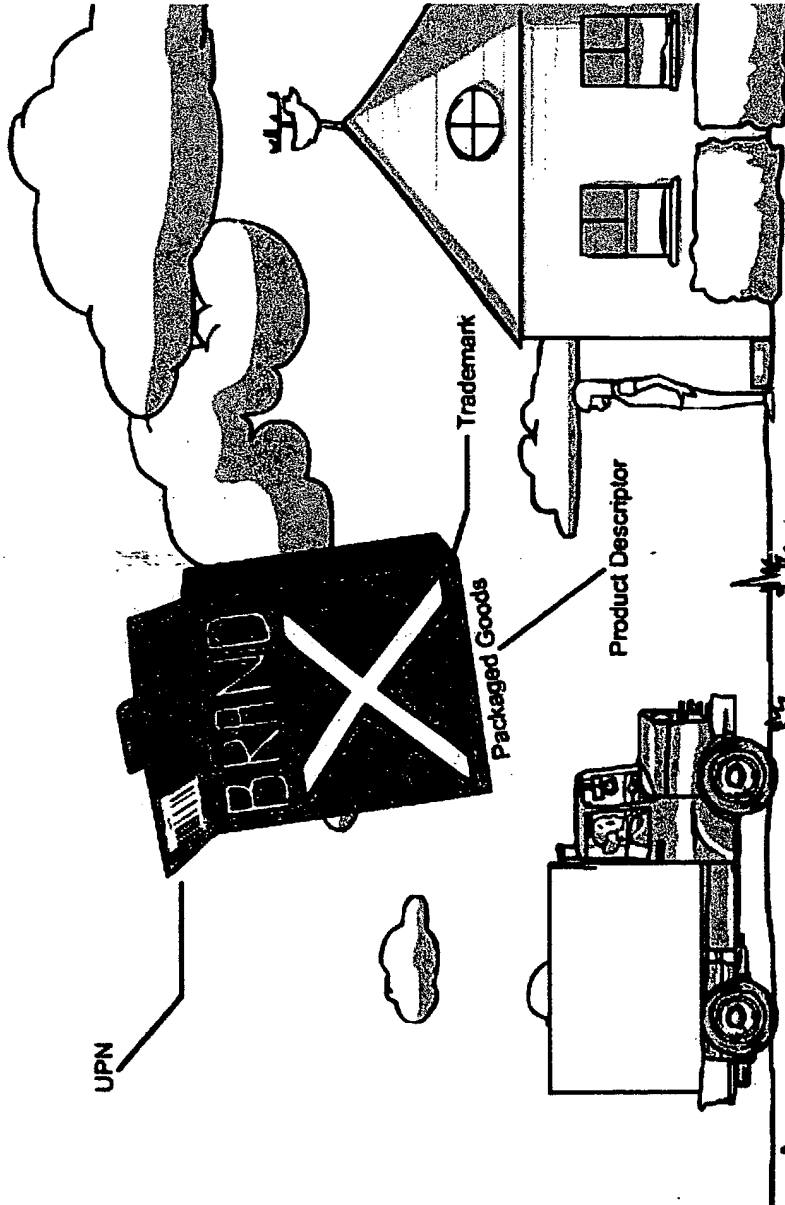

Fig. 53D16

987/1046

...automatically import it using
Brandkey's Import Data Strings
function.

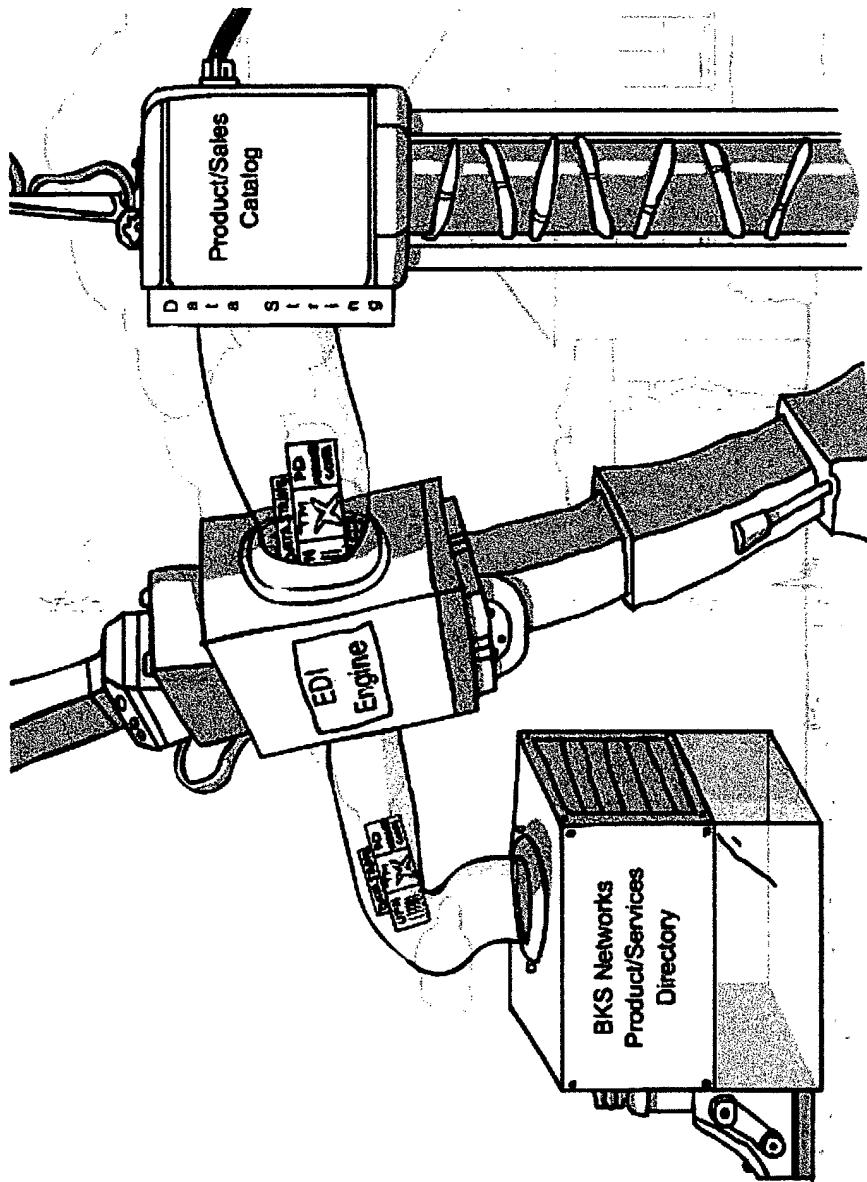

Fig. 53D17

988/1046

Then you decide which ad,
promo or other brand
building links (or URLs) you
wish to attach to the Data
String on your Multi-Mode
Virtual Kiosk.

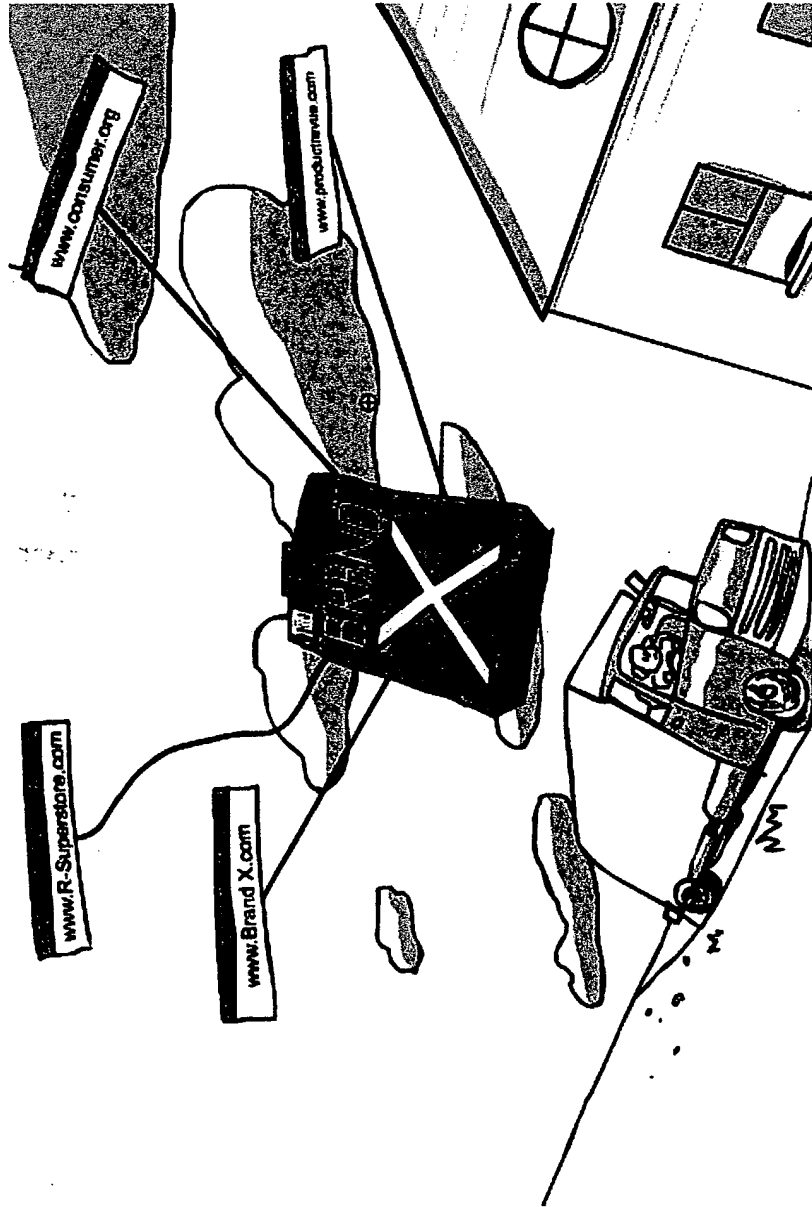

Fig. 53D18

989/1046

To help reinforce the essence and character of the brand, Brandkey Create allow you to design a display schema which presents the brand information resources in the network.

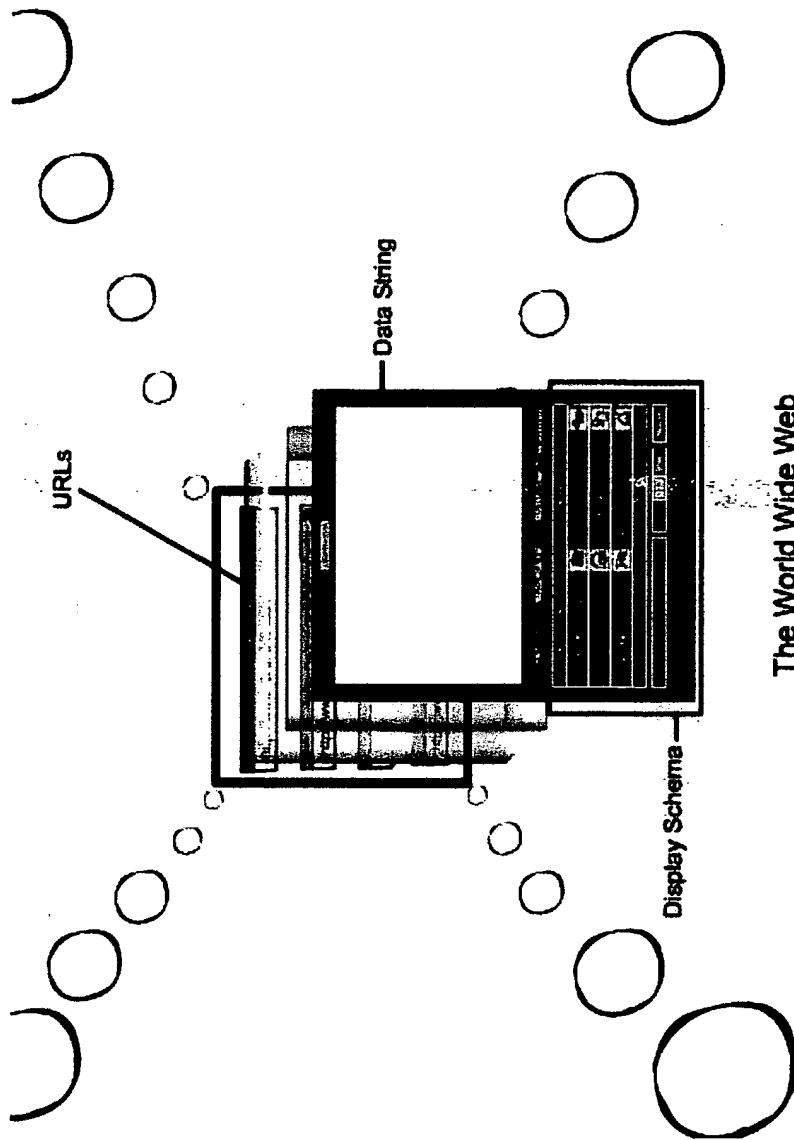
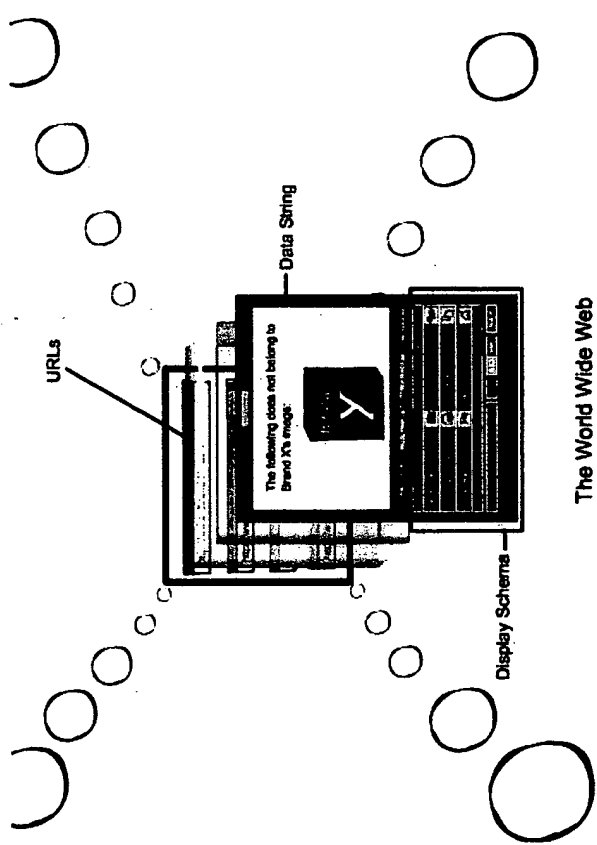

FIG. 53D19

Once you've created the content that will appear on the kiosk, you can simply and quickly preview the composite brand image likely to be projected by the Brand Information Network.

Using the 'test link' feature, IT managers can ensure that an ad spot or other link loads quickly.



The World Wide Web

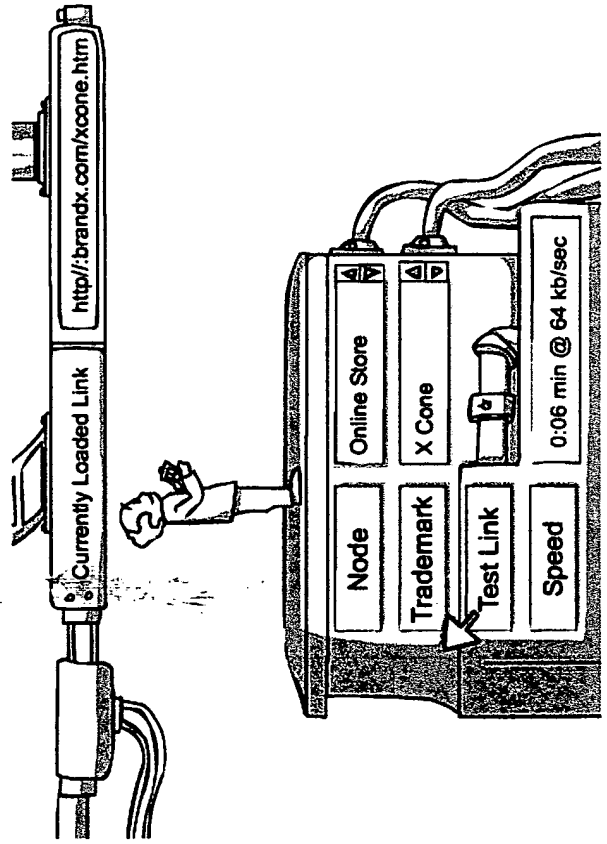

Fig. 53D20

991 / 1046

Brandkey Create also includes easy to use tools that enable brand management teams to host content on the Web as well.

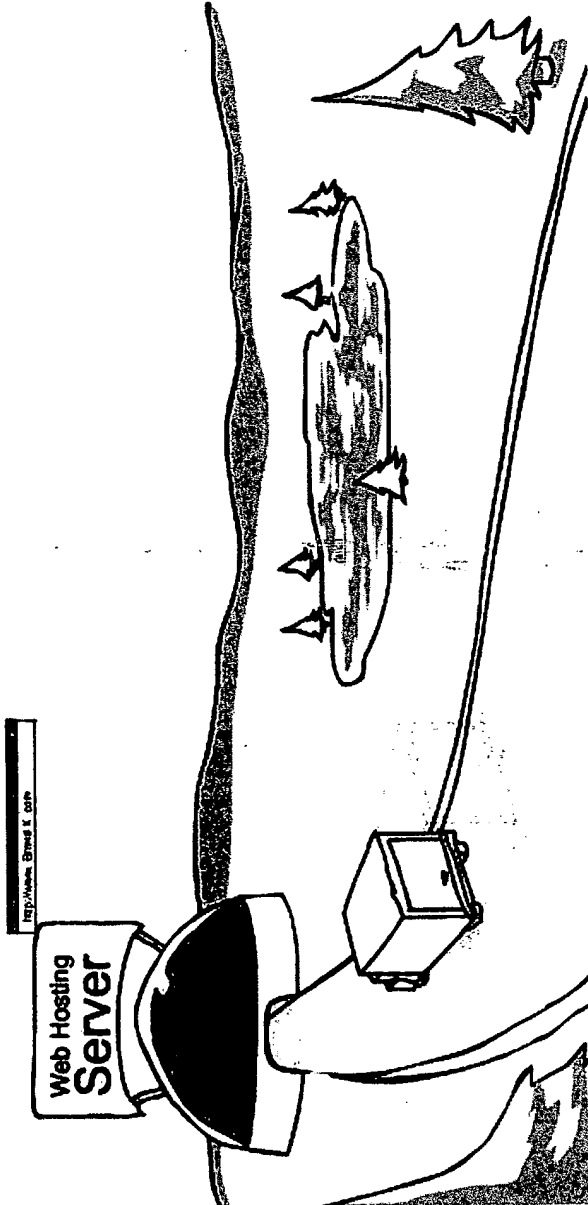

Fig. 53D21

992/1044

Along with its other benefits, Brandkey can be a very useful tool to manage your brand online.

When you wish to change information about your brand, Brandkey will automatically synchronize the information on both the supply and demand sides of the chain.

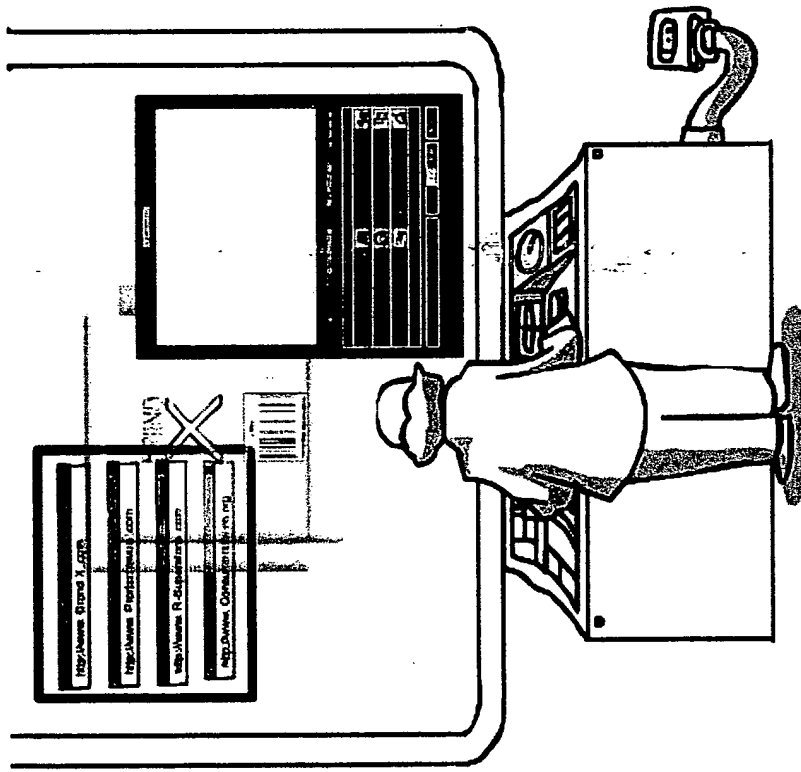

Fig. 59D22

Types of Multi-Mode Virtual Kiosks

Multi-Mode Virtual Kiosks come in a variety of types and sizes designed for the special needs of your trading partners..

Your Multi-Mode Virtual Kiosk can feature one product or several products.

Services can be showcased in a special manner.

Retailers can create kiosks that present multiple vendors, without overwhelming their own brand.

Corporate and industry-specific kiosks are yet other types of Multi-Mode Virtual Kiosks.



Products:



Services:



Retailers:



Corporate:



Industry:

Fig. 53D23

994/1046

In Brandkey Deliver, you set the kiosk in motion. You can rapidly configure, deploy and install a Multi-Mode Virtual Kiosk in as little as ten minutes.

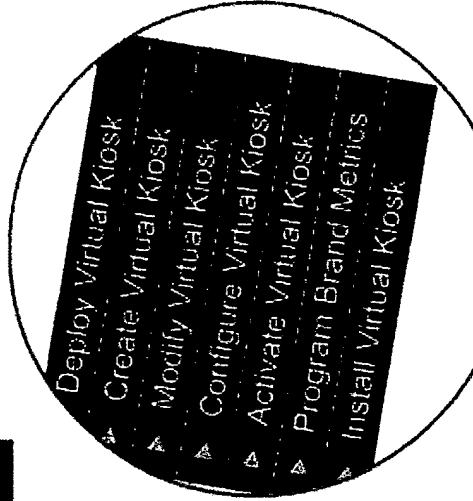
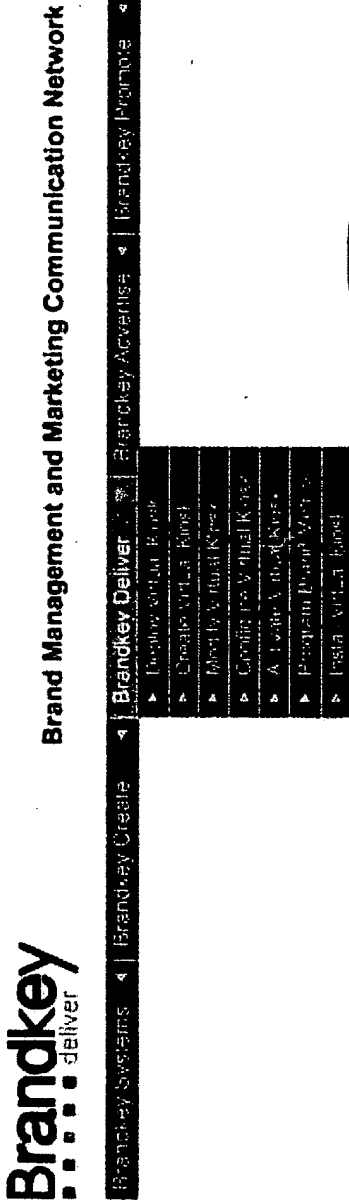

Fig. 53 D 24

995/1046

58

You generate a Multi-Mode Virtual Kiosk
by following a few simple steps:

- Configure
- Create
- Deploy
- Activate

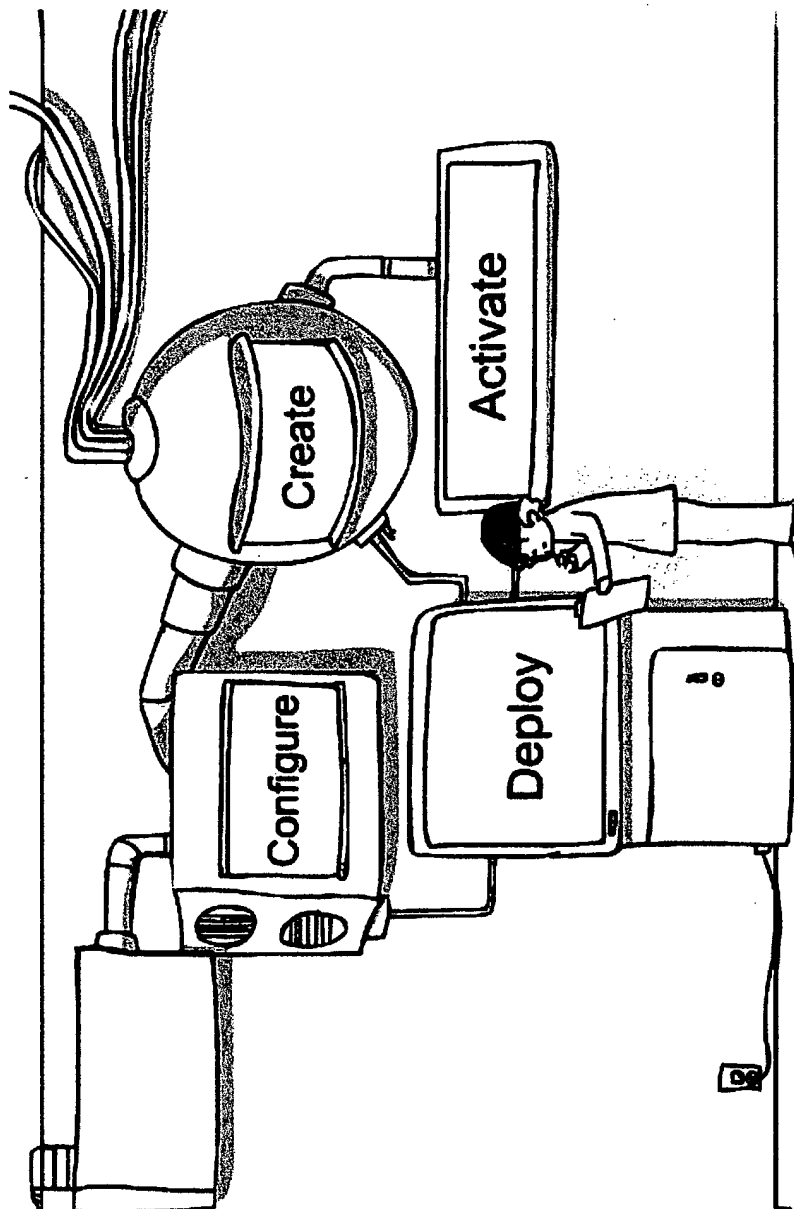

Fig. 58D25

996/1046

You begin by configuring the Multi-Mode Virtual Kiosk. Select the modes and installers, and define the domains where the Multi-Mode Virtual Kiosk can and cannot be installed.

Here you can ensure that your kiosks will not appear on a competitor's site, for example.

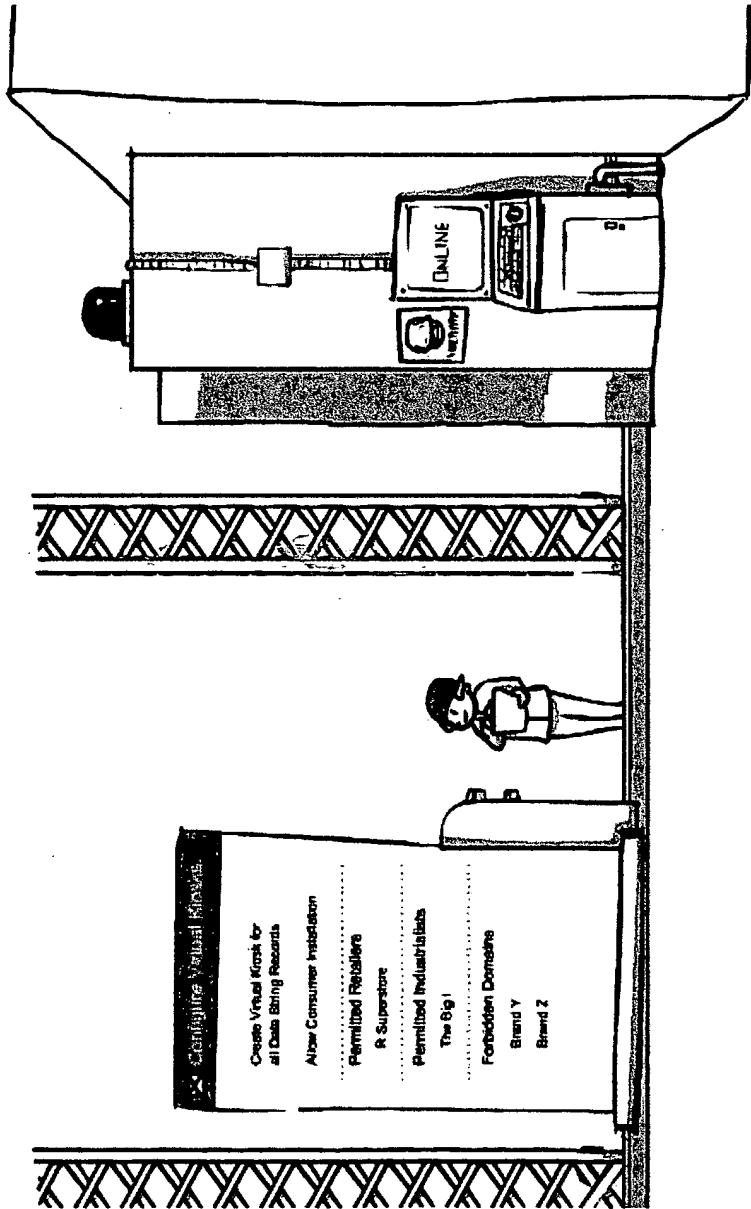

Fig. 53026

997/1046

You then can determine the look and feel of the Multi-Mode Virtual Kiosk by choosing colors, wallpaper, textures, etc.

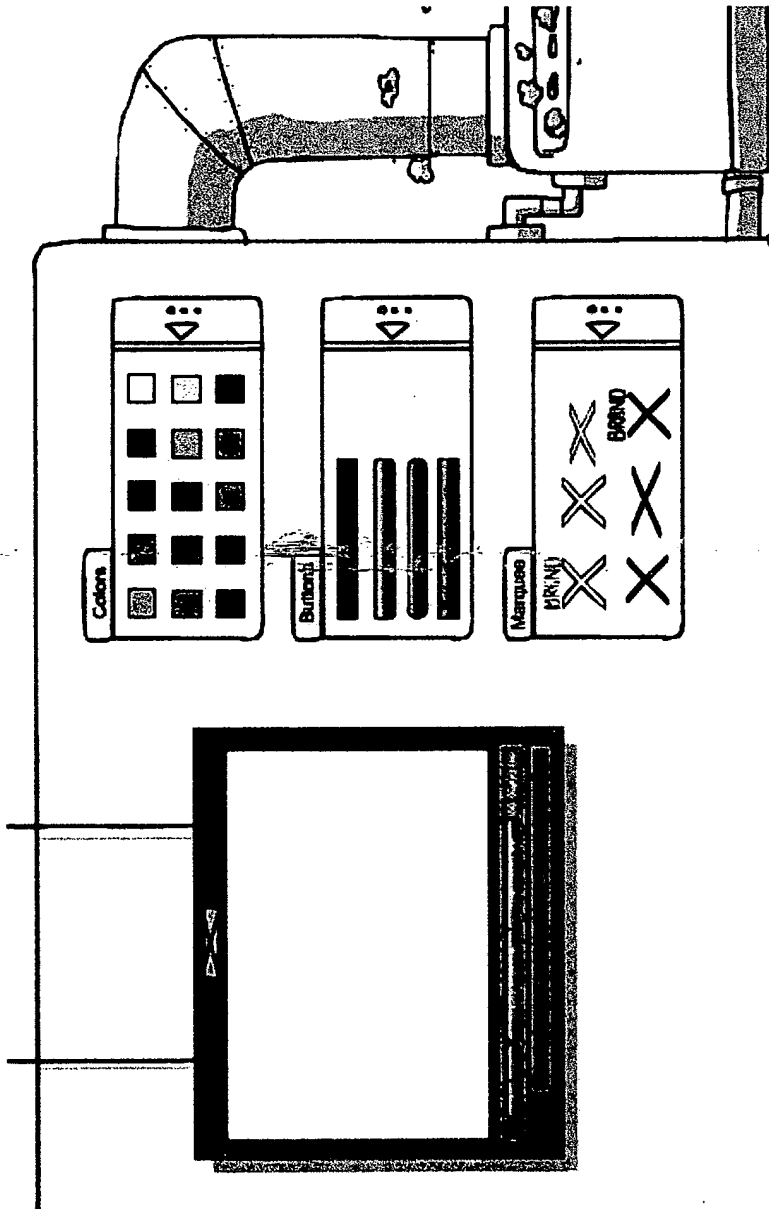

FIG. 53D27

990/1046

In step three, deployment, you decide which launch environments you want ...

Will the Multi-Mode Virtual Kiosk be a link embedded in an email to prospective customers?

A link in a registration package for new customers?

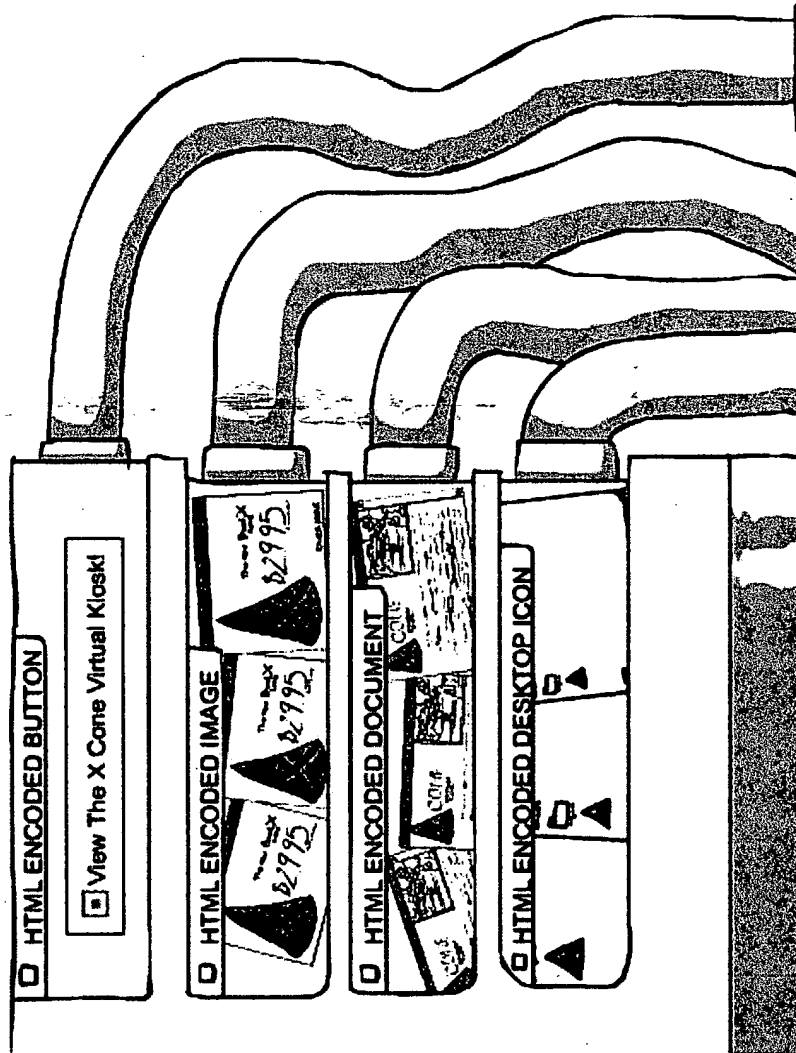

Fig. 53D28

999/1046

... or an image of a product that consumers might click on while shopping on an e-commerce site.

You can provide this image or you can insert the Default Brandkey button when you do not have an image.

<http://www.Brand X.com/x-cone.html>

TRY the NEW X Cone!

It delivers all the punch of the original Brand X but in a new fancy shape!

Product Features

- Enjoy it's pointiness
- marvel at how orange it is.
- be the envy of those guys still using boxes!
- no assembly or batteries required
- easily accessorized with other Brand X products
- 1 year limited warranty
- Now with a patented soft-sharp technology to prevent injury
- plus, many other benefits

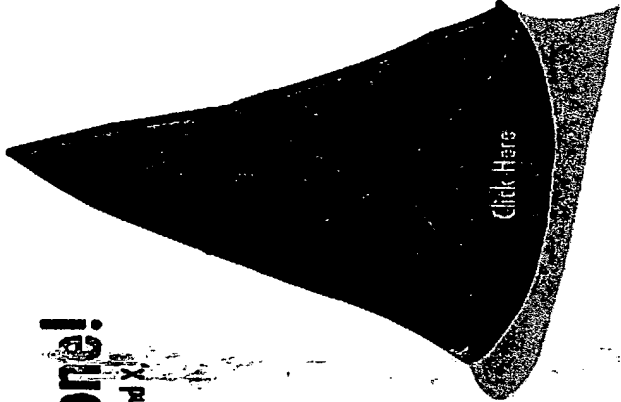

FIG. 53129

1000/1046

RA

The kiosk could even be a link in a fact sheet that consumers find while browsing on the brand's website...

Getting Started with your X Cone

Thanks for purchasing our product!

By now you are well aware of all the features available in the amazing X Cone, this user guide will walk you through all of these exciting features. To gain even more knowledge you can visit our online multi-media kiosk which enables you to fully grasp the potential of the X cone, as well as purchase accessories and other Brand X products, read consumer feedback, watch our advertisements, and get information on sales and other promotional offers. With kiosk you can also keep up to date on new products and new uses for your X Cone.

FIG. 53D30

1001/1046

... or a desktop icon which consumers can quickly install on their computer desktops, and launch anytime they want the latest sales or other information about the brand.

My Documents

My Computer

Internet

X Cone

Trash

Fig. S3D31

1002/1046

It is easy to update or otherwise modify the images or information on the Multi-Mode Virtual Kiosks.

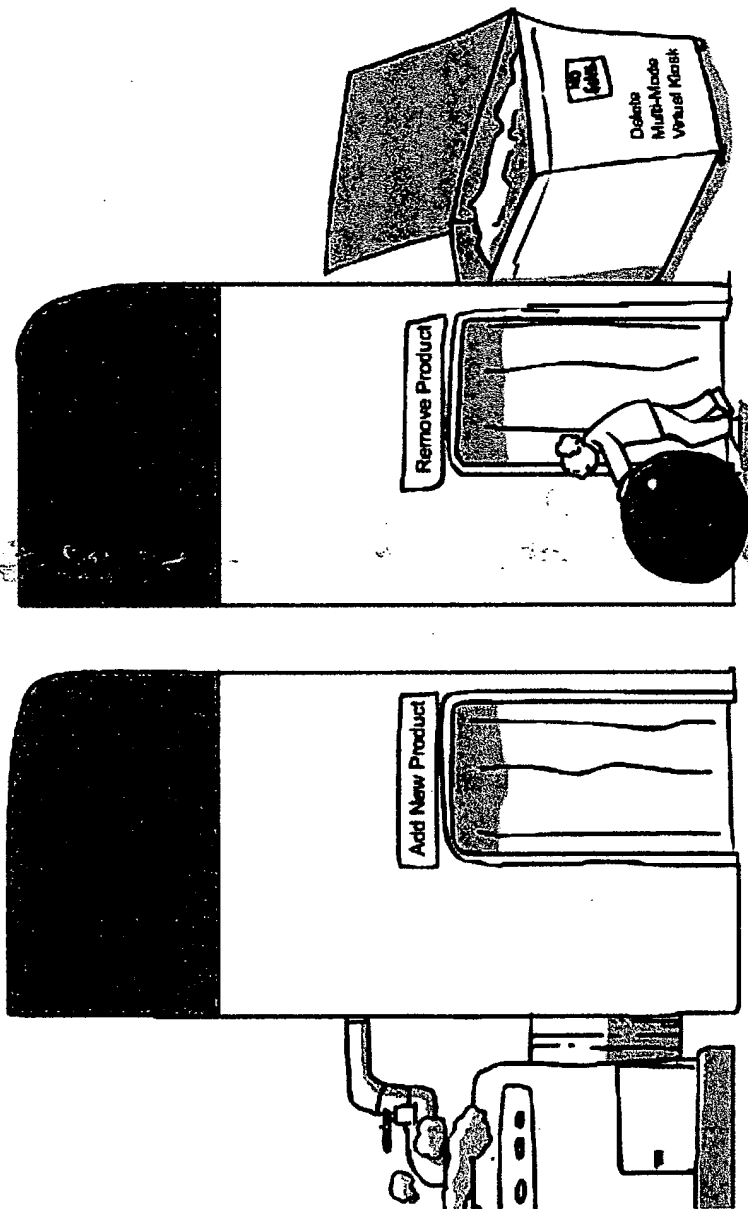
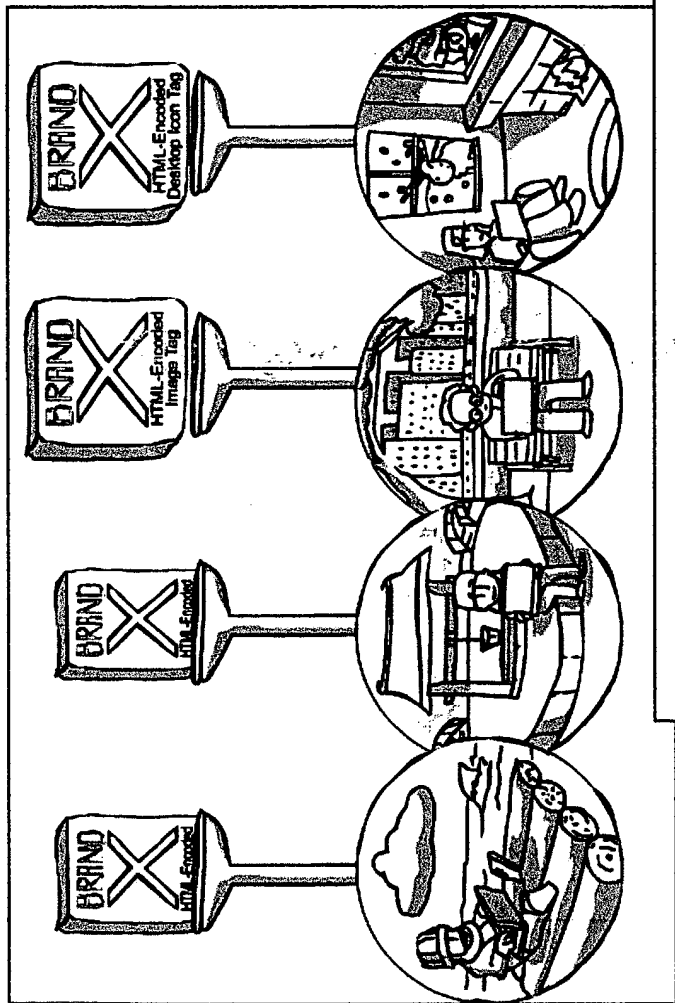

FIG. 53D32

Your kiosk receives a 'tag', or launch button, which you or your agents can embed throughout the Internet.



TRY the NEW X Cone!
 A brand new look for the popular brand.
 Get it now! Try it now!
 Try it now!
 Try it now!
 Try it now!
 Try it now!
 Try it now!
 Try it now!

Getting Started with your X Cone
 How to get started with your X Cone.
 This guide will help you get started with your X Cone.
 It includes information on how to use the X Cone.
 It also includes information on how to get started with your X Cone.
 It is a quick and easy guide to get you started with your X Cone.
 It is a quick and easy guide to get you started with your X Cone.

Fig. 53034

Then, when a consumer clicks on a tag
you have embedded somewhere along
the fabric of the Web....

... your Multi-Mode Virtual Kiosk
launches from the Brandkey Server, and
appears on the consumer's web-enabled
computer.

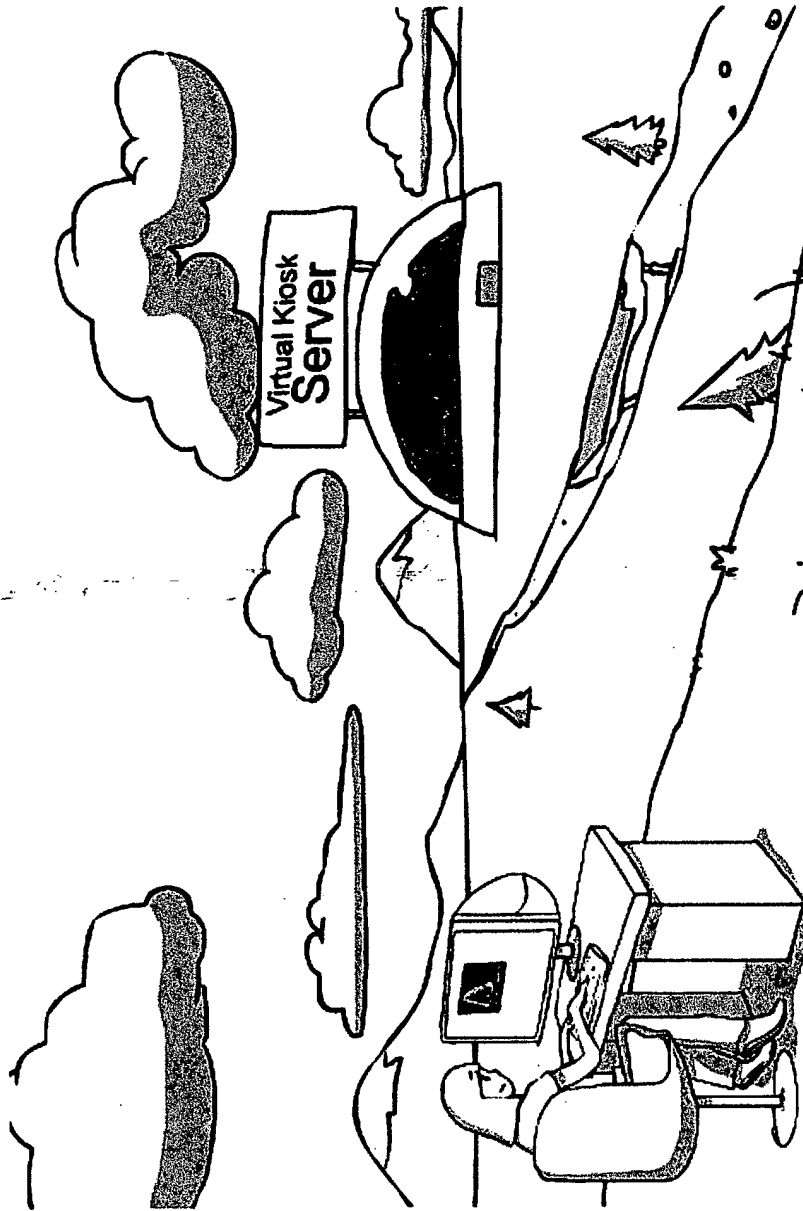

FIG. 53D35

1000/1046

Once consumers launch your Multi-Mode Virtual Kiosk, it automatically plays through its three display modes, inviting them to interact with ad spots, promotional spots, and a rich network of brand-building information.

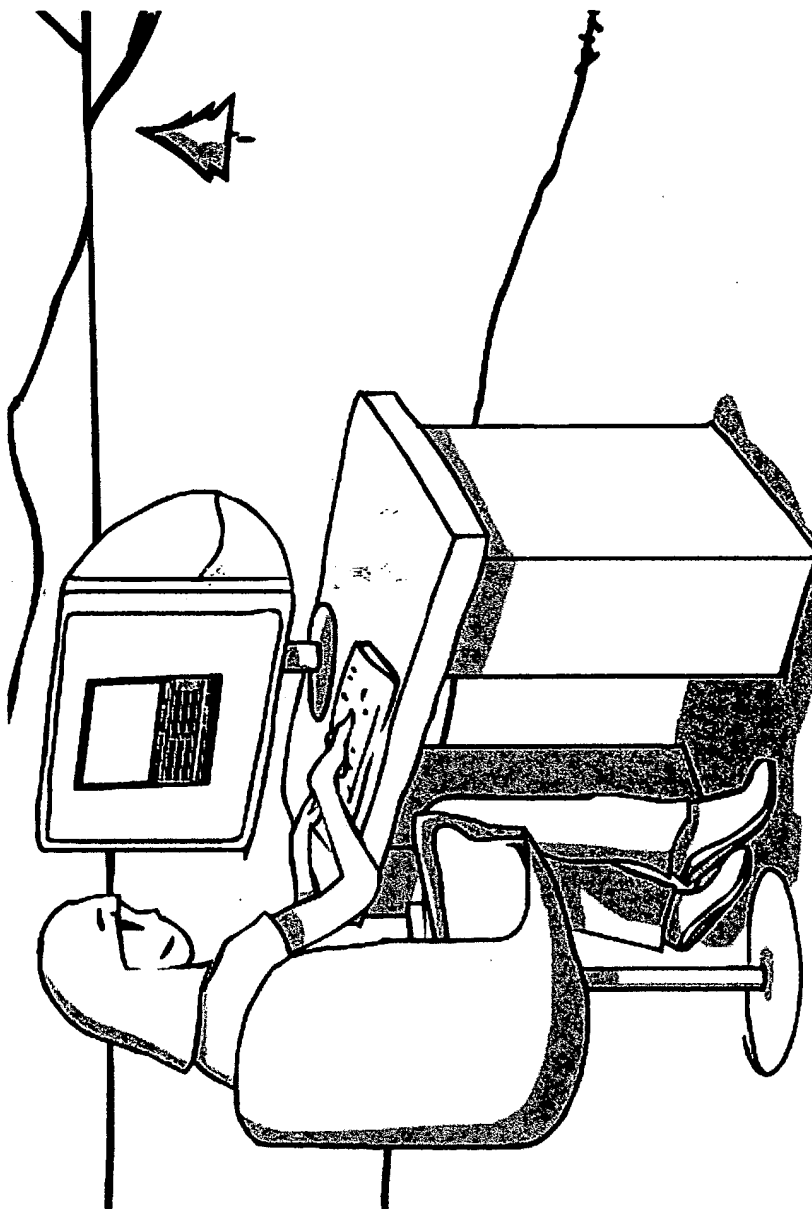

FIG. 53D36

Brandkey also allows you to quickly measure the interaction between consumers and Multi-Mode Virtual Kiosks.

For example, you can ask consumers to rate from 1 - 5 how useful a link was to them.

Brandkey can generate detailed reports to help you analyze the effectiveness of your brand- building campaigns.

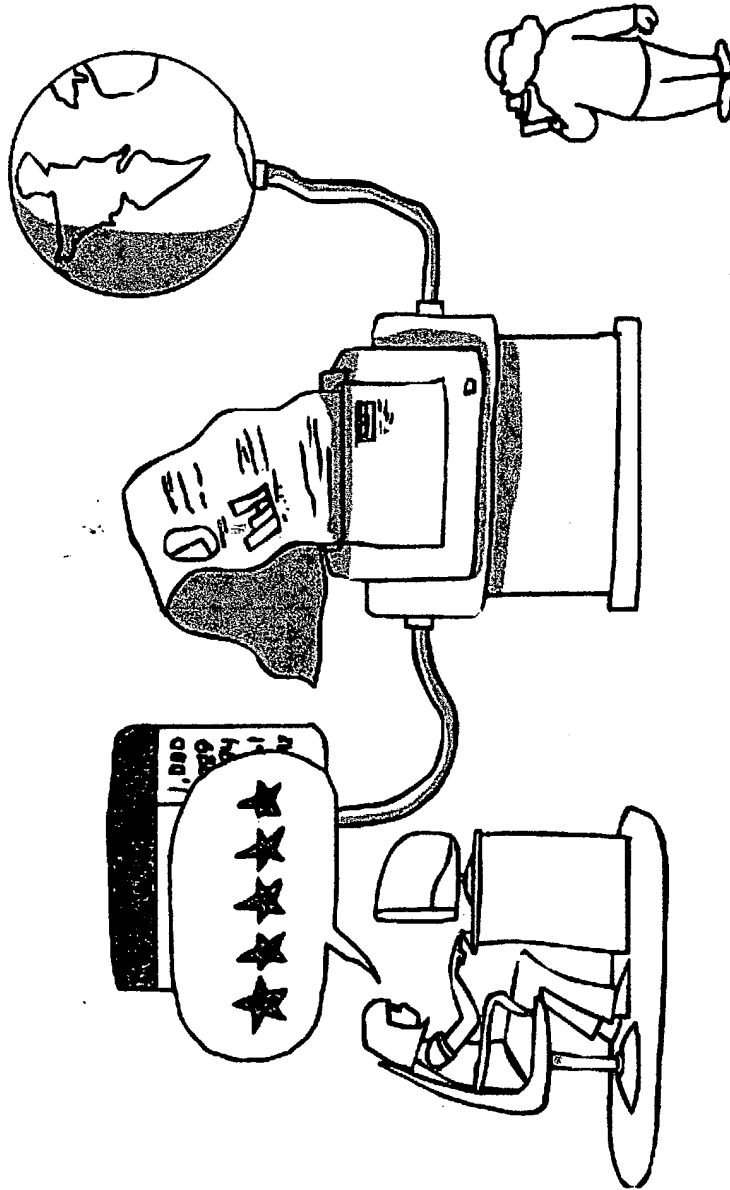

FIG. 53 D 37

1008/1046

Brandkey also simplifies
the challenge of managing
online advertising and
promotion campaigns
with Brandkey Advertise
and Brandkey Promote.

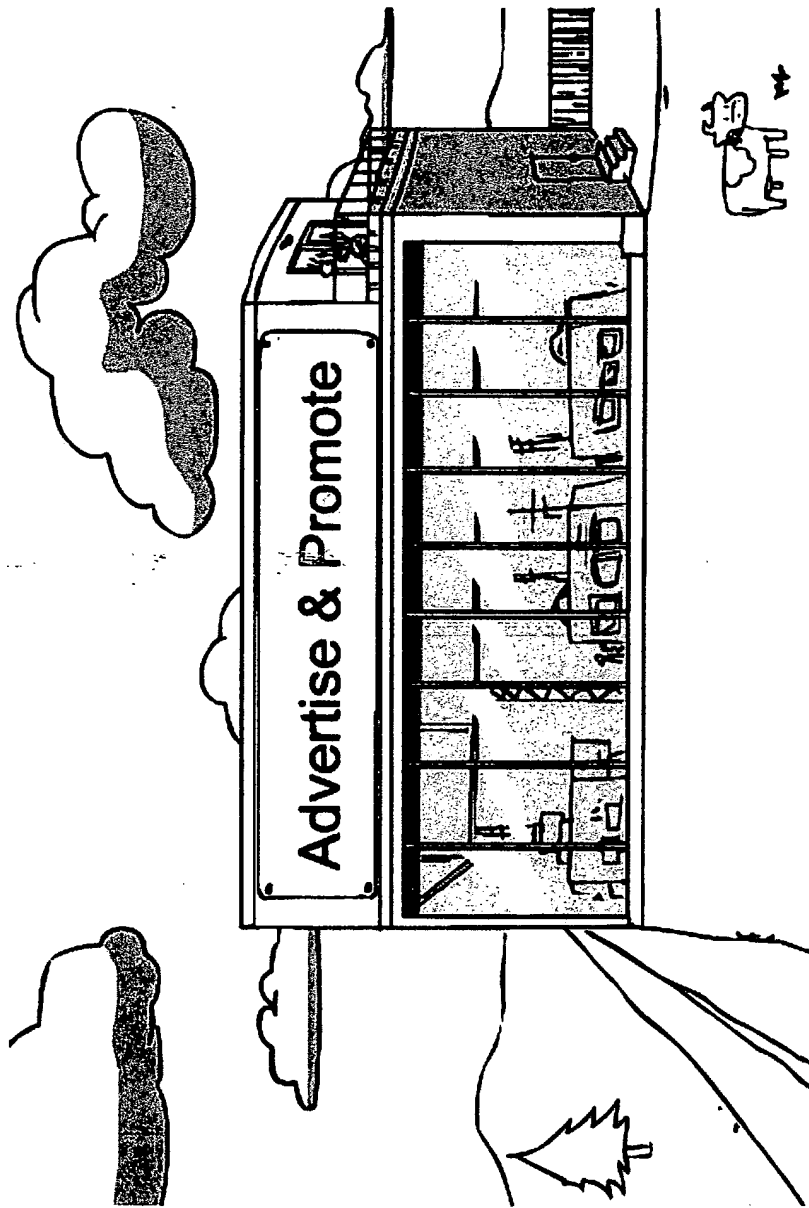

FIG. 53D 38



Brand Management and Marketing Communication Network

- Brandkey Systems
- Brandkey Create
- Brandkey Deliver
- Brandkey Advertise
- Brandkey Promote

- Directory Management
- Campaign Management
- Ad-Spot Management

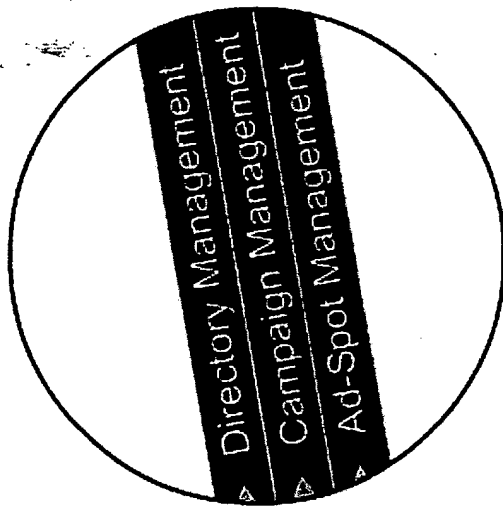

1009/1046

FIG. 53739



Brand Management and Marketing Communication Network

- Brandkey Systems
- Brandkey Create
- Brandkey Deliver
- Brandkey Advertise
- Brandkey Promote
 - Brandkey Management
 - Campaign Management
 - Promo-Spot Management

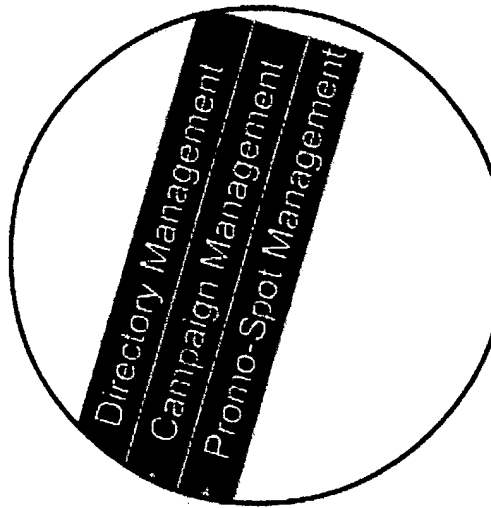

1010/1046

FIG. 53D40

Advertising and Promotion Directories can automatically produce directory listings of all the installed Multi-Mode Virtual Kiosks on which agents may place ad or promotion spots on the World Wide Web.

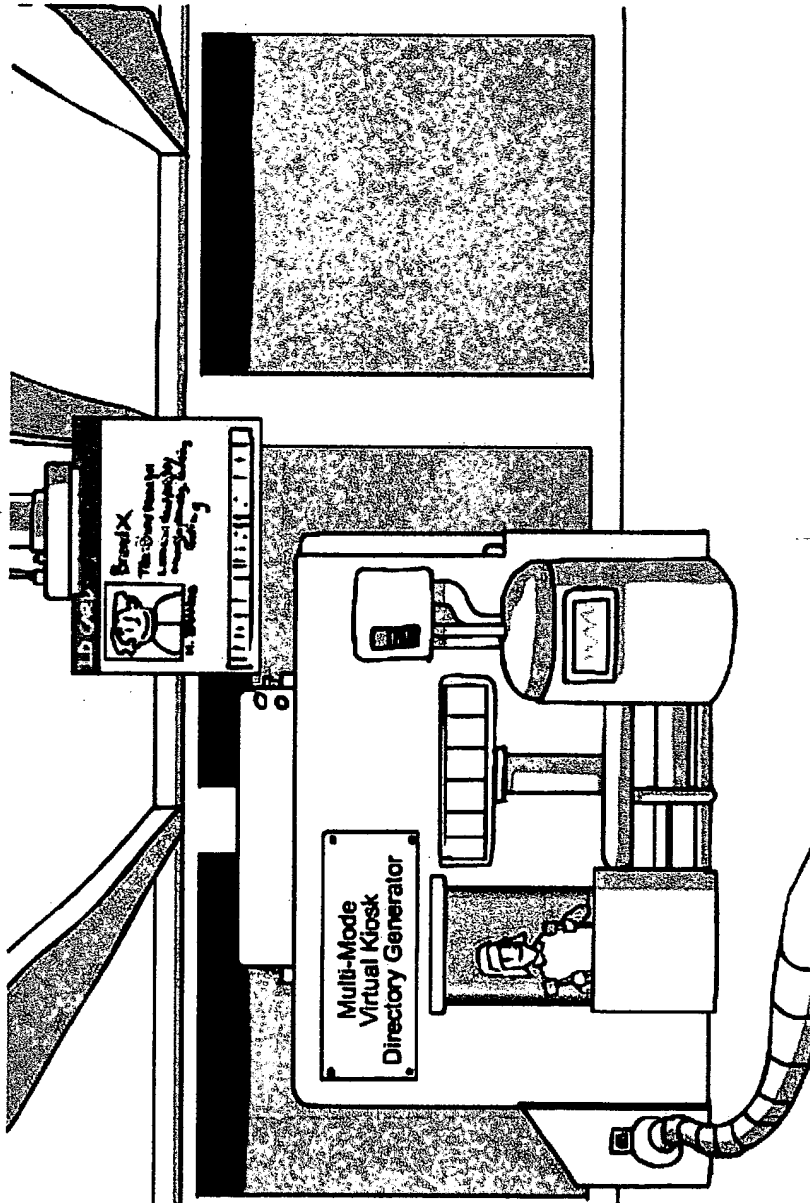

FIG. 53D41

1012/1046

Authorized agents can quickly start,
stop or modify campaigns.

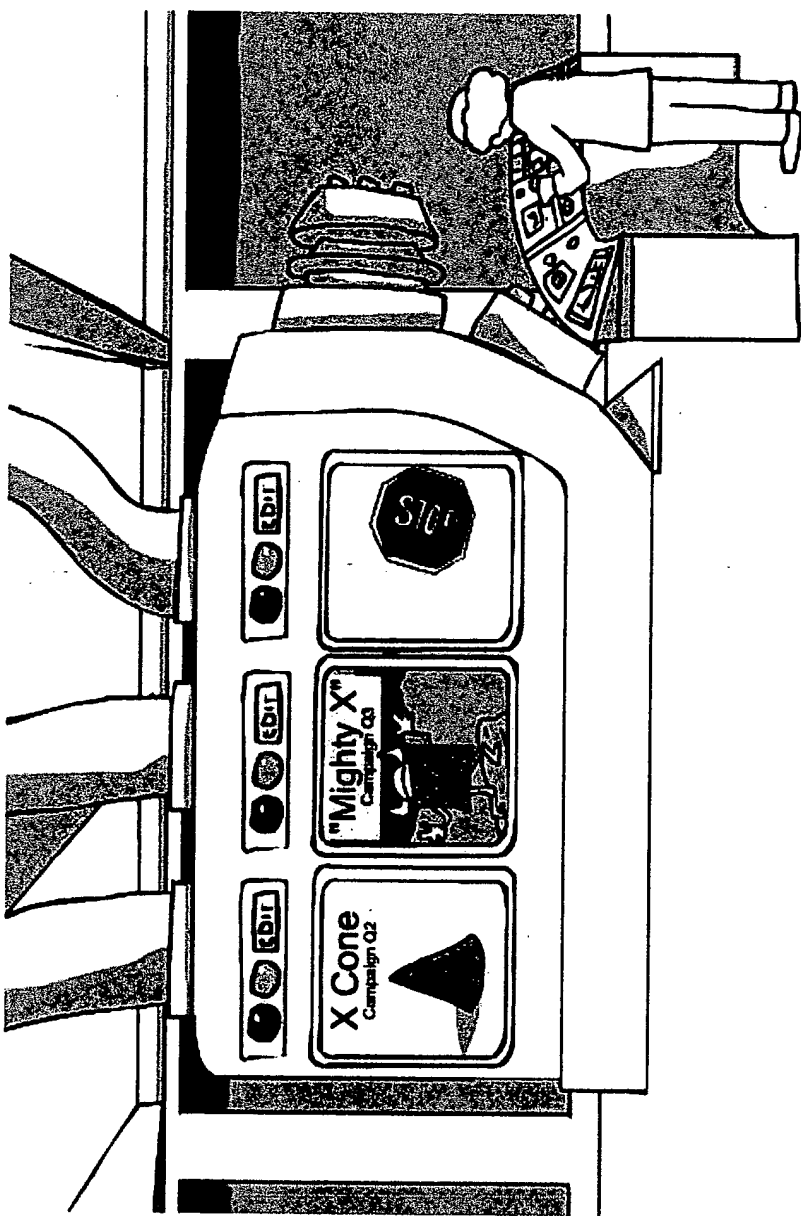

FIG. 53DA2

1013/1046

With Brandkey Systems
Multi-Mode Kiosks so easy to create and
deploy, you have the opportunity to
quickly reach millions of consumers
on the Web ...
and effectively communicate
a multi-dimensional picture
of your brand.

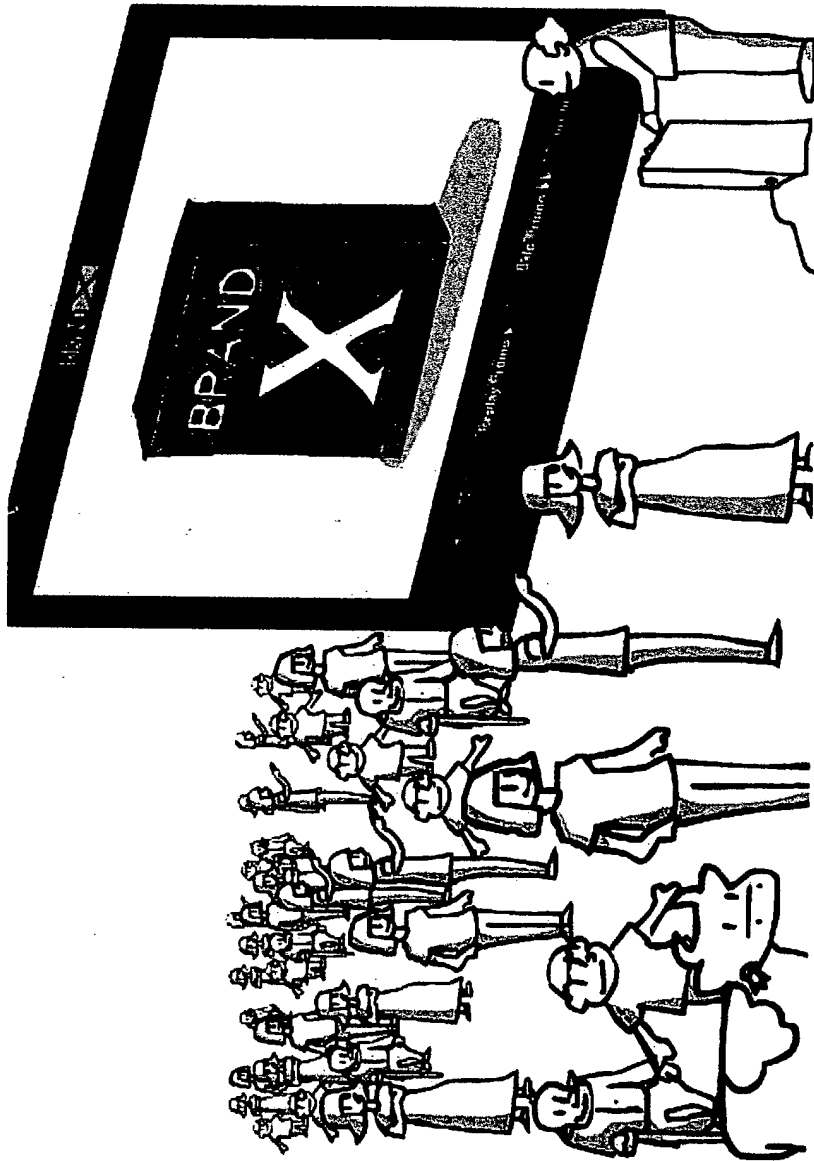

FIG. 53D43

1014/1046

Everything is within your control to ensure that consumers receive the brand-building messages consistent with your marketing team objectives.

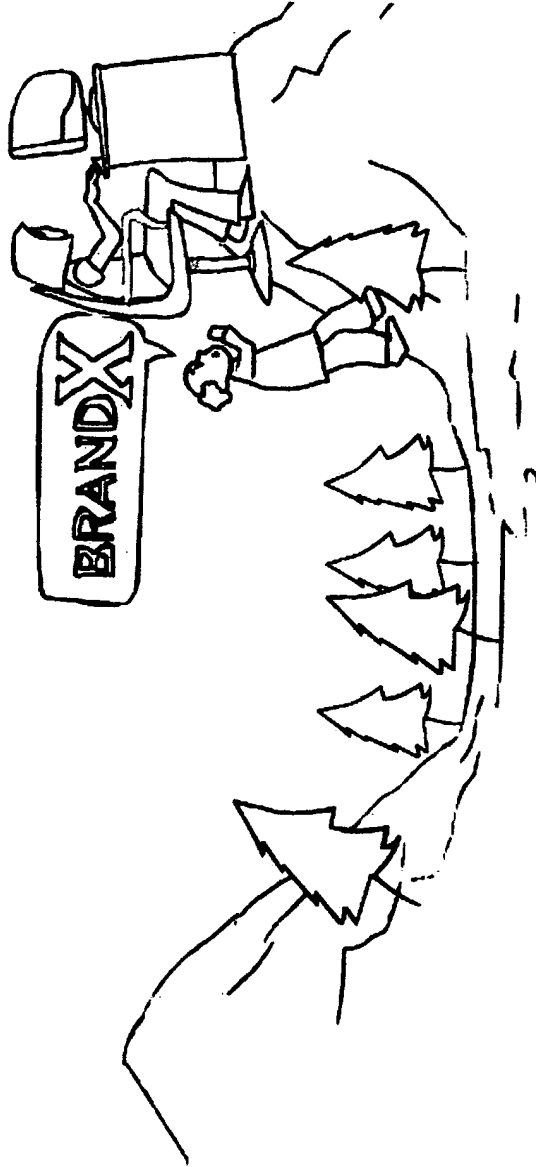

FIG. 53D44



Brandkey Systems	Brandkey Create	Brandkey Deliver	Brandkey Advertise	Brandkey Promote

BKS™ Networks, Inc. provides brand managers with a revolutionary new brand management and marketing communication media designed to serve as a central control center for managing and marketing their brands everywhere on the Internet, over all Web-based consumer touch-points, now and into the future. Using BKS™ Network's powerful tools, brand managers can quickly and easily create a multi-dimensional picture, or "Multi-Mode Virtual Kiosk" of their brand online -- and deliver it instantly to shoppers at e-retail sites and other critical touch points on the Web where - and when-- consumers are considering an online purchase.

Consumers who click on the BKS™ Multi-Mode Virtual Kiosk can find out about the brand's latest promotions, get detailed product information, watch an ad, search the store locator or locate other information. Not only do BKS™ Multi-Mode Virtual Kiosks bring valuable brand information directly to the consumer at the critical point of purchase, but they enable brand managers to influence the consumer more than ever before before, during and after online purchases.

BKS™ Multi-Mode Virtual Kiosks are easy to build and deploy. You can create a BKS™ Multi-Mode Virtual Kiosk in minutes at your own computers using the following five tools:

- Brandkey Create: choose the links that consumers will see in the ad, promo and brand information network display modes of Multi-Mode Virtual Kiosks.
- Brandkey Deliver: create, deploy and install Multi-Mode Virtual Kiosks.
- Brandkey Advertise: build, run and manage advertising campaigns on Multi-Mode Virtual Kiosks.
- Brandkey Promoter: build, run and manage promotional campaigns on Multi-Mode Virtual Kiosks.
- Brandkey Systems: track and manage the users and brands on Multi-Mode Virtual Kiosks.

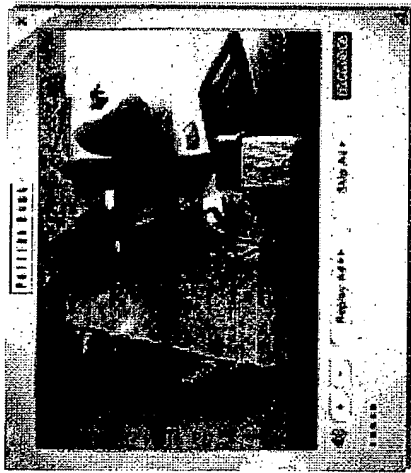

FIG. 54A

Manage

Accounts, Brands and User Rights

Manage your Accounts, Brands, and User's Rights to access the BKS Network and program the Advertisement and Promotion Display Modes of your Multi-Mode Virtual Kiosks.

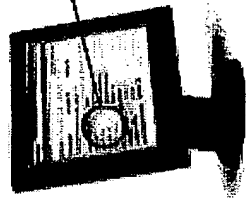
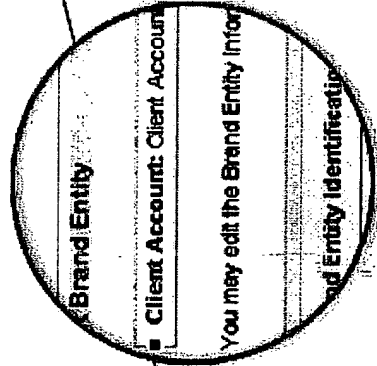
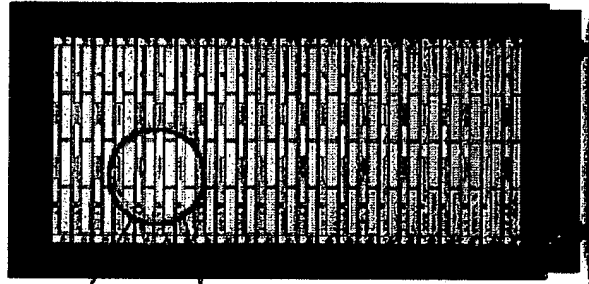

Fig. 54B

1016/1046

1017/1044



- Brandkey Systems
- Brandkey Create
- Brandkey Deliver
- Brandkey Advertise
- Brandkey Promote

Registration

Register your Client Account by completing the Client Information Application for review by the BKS Administrators.

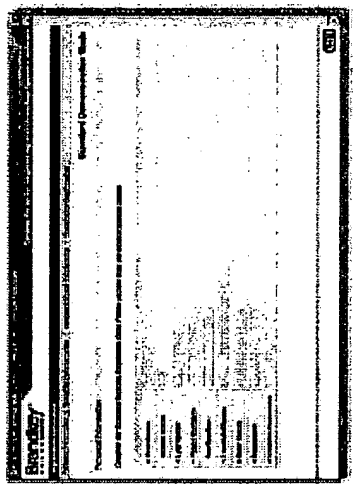

Click here to view larger screen

Fig. 54C

1018/1046



Operational Mode

Personal Information

Complete the Brandkey Systems Registration Form. Please provide your personal information below.

★ First Name:	<input type="text"/>
Middle Name:	<input type="text"/>
★ Last Name:	<input type="text"/>
★ Phone Number:	<input type="text"/>
Fax Number:	<input type="text"/>
★ E-mail Address:	<input type="text"/>
★ User Name:	<input type="text"/>
★ Password:	<input type="text"/>
★ Confirm Password:	<input type="text"/>

[Click here to return to previous page](#)

Fig. 54D



W19/1046

Back

User Account Administration

- ▶ Administer Account Users and set their Rights to use specific Services delivered by the BKS Network.
- ▶ Administer your Account, the Trade/ServiceMarks associated with your Brand Entities, Account Access Rights to the BKS Network, and certify your Ad/Promo Agents.
- ▶ Set Ad/Promo Privileges of your Business Associates to place the Ad/Promo Spots on your installed Multi-Mode Virtual Kiosks.
- ▶ View Brand Metrics relating to Services delivered to your Account's Users by the BKS Network.

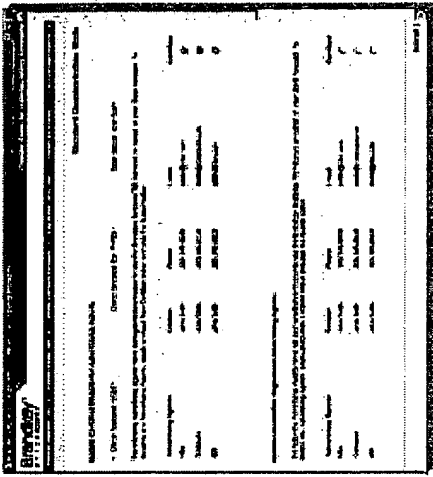

Click here to view larger screen

F16, 54E

1020 / 1046



Control Panel for Administering Accounts

- Update Company Info
- Update Admin Info
- Update Available Services
- Edit Brand Entity Info
- Certify Ad Agents
- Certify Promo Agents

Operational Mode

Update Certified Registered Advertising Agents

Client Account: Client Account 1 Client Account No: BKS-CA-A-0002003 User Name: John Smith

The following Advertising Agents have been granted permission to use the Brandkey Systems(TM) Network on behalf of your Client Account. To decertify any Advertising Agents, simply uncheck their Certified status and click the Submit button.

Advertising Agents	Contact	Phone	E-mail	Certified
Advertising Agent 1	John Doe	203-555-1001	jdoe@aagent1.com	<input checked="" type="checkbox"/>
Advertising Agent 2	John Doe	203-555-2002	jdoe@aagent2.com	<input checked="" type="checkbox"/>
Advertising Agent 3	John Doe	203-555-3003	jdoe@aagent3.com	<input checked="" type="checkbox"/>

Update Uncertified Registered Advertising Agents

The following Advertising Agents have not been granted permission to use the Brandkey Systems(TM) Network on behalf of your Client Account. To certify any Advertising Agents, simply check their Certified status and click the Submit button.

Advertising Agents	Contact	Phone	E-mail	Certified
Advertising Agent 4	Charles Smith	203-555-4004	csmith@aagent4.com	<input type="checkbox"/>
Advertising Agent 5	Mary Smith	203-555-5005	msmith@aagent5.com	<input type="checkbox"/>
Advertising Agent 6	James Smith	203-555-6006	jsmith@aagent6.com	<input type="checkbox"/>

[Click here to return to previous page](#)

Fig. 54F



- Brandkey Systems
- Brandkey Create
- Brandkey Deliver
- Brandkey Advertise
- Brandkey Promote

Create

Brand Information Networks

Create interactive Brand Information Networks designed to manage and communicate the essential value and character associated with your branded products and services.

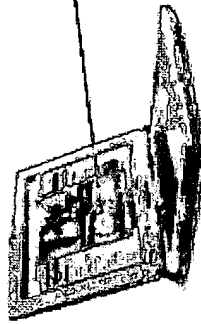
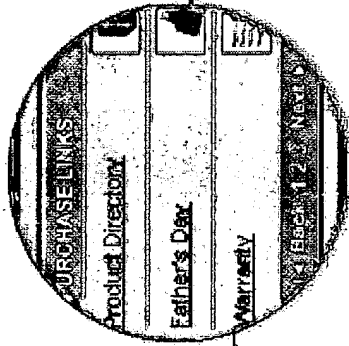
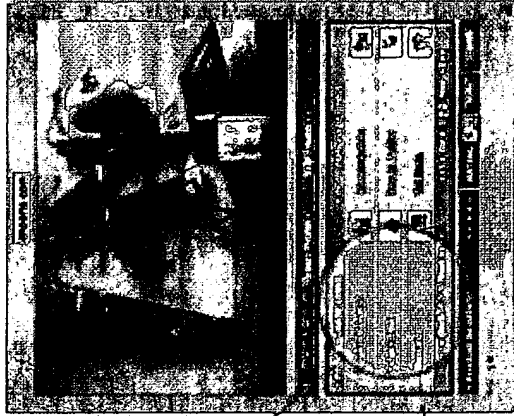

Fig. 546

1022/1046



- Brandkey Systems
- Brandkey Create
- Brandkey Deliver
- Brandkey Advertise
- Brandkey Promote

Manage Brand Information Networks

- Select the Brand Entry assigned to your Client Account in which you wish to manage the Brand Information Networks associated with your Products and Services.
- Configure Branded Product and Services attributes to be associated with your Brand Information Networks.

Manage Branded Product and Services Data Strings used to create your interactive Brand Information Networks.

- Import Data String Records from your supply-side database into the BKS Network.
- And when your Product and Services packaging changes you can Search/Manage Data String Records.
- Create New Data string Records whenever you add new Products or Services to your line.
- To stay in step with your supply-side product database, Synchronize Data String Records.

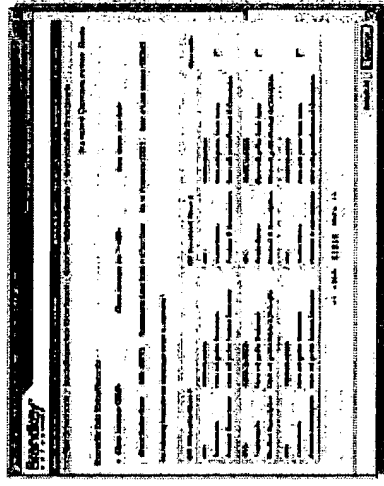

Click here to view larger screen

FIG. 54H

1023/1046



Control Panel for Managing Brand Information Network

- Select Brand Entity <
- Configure Control Panel <
- Manage Product Data Strings >
- Manage Product Data Links <

- Support Data String Records | Search/Manage Data String Records | Create New Data String Records | Synchronize Data String Records |

Operational Mode

Overwrite Data String Records

Client Account: Client Account 1 Client Account No: BKS-CA-A-0002003 User Name: John Smith

Brand Entity: Brand Entity 1 MIN: 123456 Trademark: Trademark 1 No. of Products: 00003 Date of Last Import: 09/03/03

The following Products are duplicated. Which to overwrite?

BKS Networks Record			832 Document Record			Overwrite
UPC:	123456123456		UPC:	123456123456		<input type="checkbox"/>
Trademark:	Trademark 1		Trade Name:	Trademark 1		<input type="checkbox"/>
Product Descriptor:	Product Descriptor 1		Product ID Description:	Product Descriptor 1A		<input type="checkbox"/>
UPC:	123456123457		UPC:	123456123457		<input type="checkbox"/>
Trademark:	Trademark 2		Trade Name:	Trademark 2		<input type="checkbox"/>
Product Descriptor:	Product Descriptor 2		Product ID Description:	Product Descriptor 2A		<input type="checkbox"/>
UPC:	123456123458		UPC:	123456123458		<input type="checkbox"/>
Trademark:	Trademark 3		Trade Name:	Trademark 3		<input type="checkbox"/>
Product Descriptor:	Product Descriptor 3		Product ID Description:	Product Descriptor 3A		<input type="checkbox"/>

◀◀ | ◀ Back 1 2 3 4 5 Next ▶▶

[Click here to return to previous page](#)

Fig. 54I

1024 / 1046



- Brandkey Systems
- Brandkey Create
- Brandkey Deliver
- Brandkey Advertise
- Brandkey Promote

Manage Brand Information Networks

▼ Manage Brand Information Networks by linking your Brand Building Resources to product and service Data Strings to build Brand Information Networks designed to communicate your Brand Image.

- Search/Manage the Data Link Records of your Brand Information Networks by editing their related Data Link records.
- Extend your Brand information Networks by Creating New Data link Records.

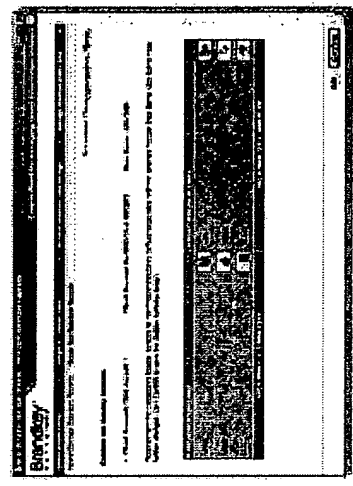

[Click here to view larger screen](#)

Fig. 54J

1025 / 1046



Control Panel for Managing Brand Information Network

- Select Brand Entity
- Configure Control Panel
- Manage Product Data Strings
- Manage Product Data Links
- Search/Manage Data Link Records
- Create New Data Link Records

Operational Mode

Confirm the Display Schema

Client Account: Client Account 1 Client Account No: BKS-CA-A-0002003 User Name: John Smith

Please review the customized Display Schema for the Product Data Links (URLs) associated with the selected Product Data String. Click Edit to make further changes. Click Confirm to save this Display Schema design.

PRE-PURCHASE LINKS		POST-PURCHASE LINKS	
Link 1		Link 4	
Link 2		Link 5	
Link 3		Link 6	
Back 1 2 3 Next > >>		Back 1 2 3 Next > >>	

[Click here to return to previous page](#)

Fig. 54K

1026/1046



- Brandkey Systems
- Brandkey Create
- Brandkey Deliver
- Brandkey Advertise
- Brandkey Promote

Host Brand Building Web Resources

Select the Brand Entity assigned to your Client Account in which you wish to manage the hosted Brand Building Web Resources associated with your Products and Services.

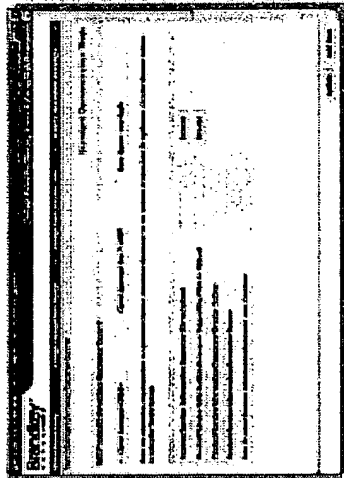

[Click here to view larger screen](#)

- ▶ View Data String Records and Brand Information Networks to obtain an overview of the Data Strings associated with your Client Account that are maintained in the BKS Network.
- ▶ View Data Link Records and Brand Information Networks to survey your associated Brand Information Resources.
- ▶ Manage Hosted Brand Building Resources on web servers maintained by the BKS Network.

Fig. 54L

1027 / 1046



Control Panel for Hosting Brand Building Web Resources

- Select Brand Entity
- Manage Product Data Strings
- Manage Product Data Links
- Manage Information Resources
- Search/Manage Information Resource Records

Operational Mode

Edit Service Information Resource Record

Client Account: Client Account 1 Client Account No: BKS-CA-A-0002003 User Name: John Smith

Enter the Information required below to Upload the Service Information Resource for the selected Service Data String Record. Click the Browse buttons to select the files to Upload.

Product/Service Information Resource File to Upload:	<input type="text"/>	<input type="button" value="Browse"/>
Product/Service Information Resource Supporting Files to Upload:	<input type="text"/>	<input type="button" value="Browse"/>
Product/Service Information Resource Creator/Author:	<input type="text"/>	
Product/Service Information Resource Owner:	<input type="text"/>	
Date Product/Service Information Resource was Created:	<input type="text"/>	

[Click here to return to previous page](#)

Fig. 54M

1028 / 1046



Brandkey Systems Brandkey Create Brandkey Deliver Brandkey Advertise Brandkey Promote

Deliver

Multimode Virtual Kiosks

Deliver Multimode Virtual Kiosks to Consumers at Web-Enabled touchpoints to develop Consumer Brand Knowledge about your branded products and services.

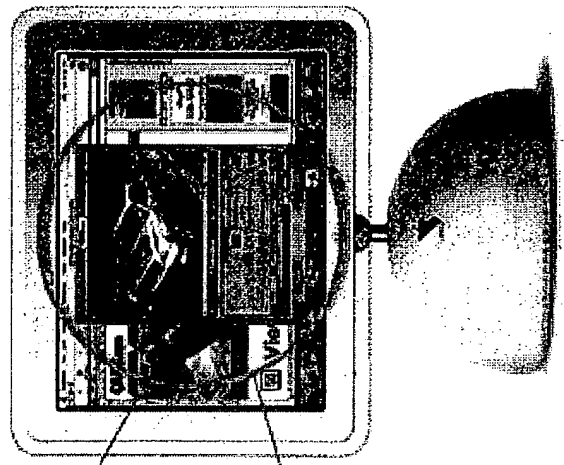
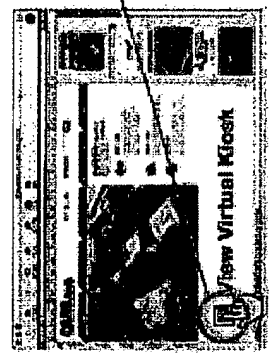

FIG. 54 N

1029/1046



Generate Virtual Kiosks

Generate Multi-Mode Virtual Kiosks designed to effectively communicate your Product or Service's Brand Image in the minds of Consumers.

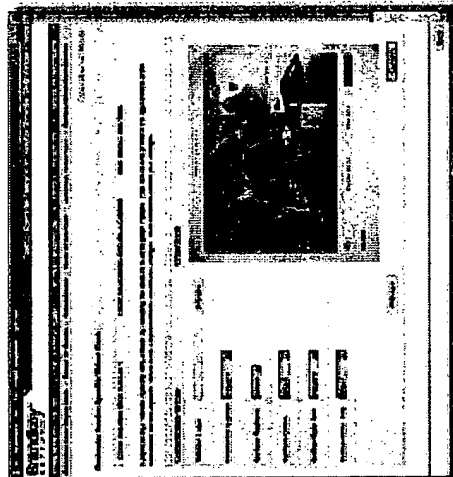

[Click here to view larger screen](#)

- ▶ Configure Multi-Mode Virtual Kiosks by specifying where and who may install your Multi-Mode Virtual Kiosks, using the BKS Network.
- ▶ Customize your Multi-Mode Virtual Kiosks to reflect the look and feel of your Brand.
- ▶ Deploy your Multi-Mode Virtual Kiosks over diverse and widespread Launch Environments.

Fig 540

1030/1046



Control Panel for Generating Vendor-Specific (V-S) Virtual Kiosks

- Configure V-S Virtual Kiosks <
- Create V-S Virtual Kiosks
- Modify V-S Virtual Kiosks
- Deploy V-S Virtual Kiosks
- Activate V-S Virtual Kiosks
- Set Virtual Kiosk Display Mode
- Select for Brands
- Select Brands
- Name Virtual Kiosk
- Customize Virtual Kiosk
- Confirm Virtual Kiosk Creation

Operational Mode

Client Account: Client Account 1 Client Account No: BKS-CA-A-0002003 User Name: John Smith

Customize your Vendor-Specific Virtual Kiosk by selecting the desired Customization Options. Click Preview to preview the appearance of the customized Vendor-Specific Virtual Kiosk. Click Confirm to confirm the changes. Click Cancel to cancel your changes.

Customization Options		Virtual Kiosk
Vendor Logo:	<input type="text"/> <input type="button" value="Browse"/>	
Geometric Layout:	<input type="text" value="square"/>	
Surface Texture:	<input type="text" value="Black"/>	
Surface Color:	<input type="text" value="Black"/>	
Button Style Set:	<input type="text" value="square"/>	
Button Color Set:	<input type="text" value="Black"/>	
		<input type="button" value="Preview"/>

[Click here to return to previous page](#)

Fig. 54P

1031/1046



- Brandkey Systems
- Brandkey Create
- Brandkey Deliver
- Brandkey Advertise
- Brandkey Promote

Install Multi-Mode Virtual Kiosks

Select, download, and Install Multi-Mode Virtual Kiosk Tags which launch your Brand-Building Multi-Mode Virtual Kiosks.

- ▶ Select Virtual Kiosks you wish to download, install, and access over the internet.
- ▶ Install Virtual Kiosk Tags by downloading the selected Multi-Mode Virtual Kiosks' Tags to be installed at locations which reach your target audience.

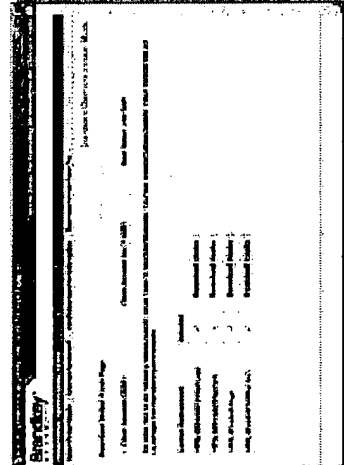

[Click here to view larger screen](#)

Fig. 54Q

1032/ 1046



Control Panel for Installing Vendor-Specific Virtual Kiosks

Install Vendor-Specific Virtual Kiosks

Select Virtual Kiosks | License Agreement | Installation Location Information | Download Virtual Kiosk Tag |

Operational Mode

Download Virtual Kiosk Tags

Client Account: Client Account 1 Client Account No: BKS-CA-A-0002003 User Name: John Smith

The setup files for the following Vendor-Specific Virtual Kiosk(s) have been prepared. You have selected Vendor-Specific Virtual Kiosk(s) that are Launchable from the following environments.

Launch Environment	Selected	
HTML-Embedded Default Logo	<input checked="" type="checkbox"/>	Download Kiosks
HTML-Embedded Document	<input type="checkbox"/>	Download Kiosks
HTML-Encoded Image	<input checked="" type="checkbox"/>	Download Kiosks
HTML-Encoded Desktop Icon	<input checked="" type="checkbox"/>	Download Kiosks

[Click here to return to previous page](#)

FIG. 5A R

1033/1046



Brandkey Systems < Brandkey Create < Brandkey Deliver < Brandkey Advertise < Brandkey Promote <

Advertise

Branded Products and Services

Advertise branded products and services by building, running and managing Advertising Campaigns on Multi-Mode Virtual Kiosks delivered to Consumers.

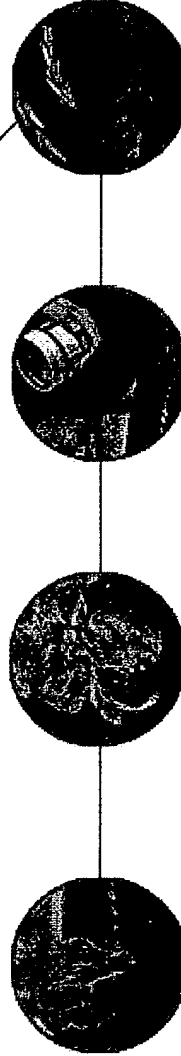
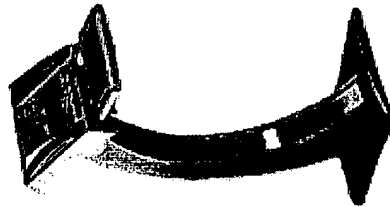
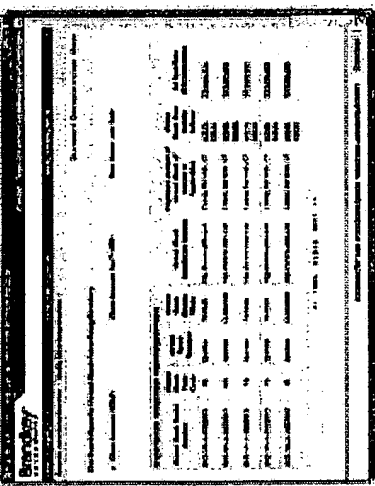

Fig. 54S

Manage Advertising Campaigns

Manage Advertising Campaigns to be run on networks of installed Multi-Mode Virtual Kiosks.

▼ Create Multi-Mode Virtual Kiosk Advertising Directories that specify on which Multi-Mode Virtual Kiosks you are permitted to run your Advertising Campaigns.



[Click here to view larger screen](#)

- Generate Advertising Directory identifying on which Multi-Mode Virtual Kiosks your Agents are permitted to run your Brand's Advertising Campaigns.
- Modify Advertising Directory that specify on which Multi-Mode Virtual Kiosks your Agents are permitted to run your Brand's Advertising Campaigns.

1034 / 1046

FIG. 54T

1035 / 1046



Control Panel for Managing Advertising Campaigns

Directory Management | Campaign Management | Ad-Spot Management

General Advertising Directory | Modify Advertising Directory

Operational Mode

The Brand-Specific Virtual Kiosk Advertising Directory

Client Account: Client Account 1 Client Account No: BKS-CA-A-0002003 User Name: John Smith

Brand-Specific Virtual Kiosk Advertising Directory							
Virtual Kiosk Serial Number	Virtual Kiosk Type Code	Virtual Kiosk Sponsor	Virtual Kiosk Display Mode	Virtual Kiosk Installation Domain	Physical Location of Virtual Kiosk (if known or Applicable)	Virtual Kiosk User Activity Indices	Ad Spot Rate (\$/Impression)
BKS-VK-A-0002003	PS	Sponsor 1	Tri-Mode	http://www.sponsor1.com	NA	activity indices	\$/impression
BKS-VK-A-0002004	VS	Sponsor 2	Dual-Mode	http://www.sponsor2.com	NA	activity indices	\$/impression
BKS-VK-A-0002005	PS	Sponsor 3	Tri-Mode	http://www.sponsor1.com	NA	activity indices	\$/impression
BKS-VK-A-0002006	PS	Sponsor 4	Tri-Mode	http://www.sponsor3.com	NA	activity indices	\$/impression
BKS-VK-A-0002007	VS	Sponsor 5	Dual-Mode	http://www.sponsor1.com	NA	activity indices	\$/impression

◀◀ | ◀ Back 1 2 3 4 5 Next ▶▶

[Click here to return to previous page](#)

Fig. 54 U



1036/1046

Manage Advertising Campaigns

Register and Manage Advertising Campaigns to be run on specified Networks on Multi-Mode Virtual Kiosks.

- Register Campaign to be run on specified Networks of Multi-Mode Virtual Kiosks.
- Flexibly add or delete Multi-Mode Virtual Kiosks at any time to Modify Campaigns.
- Stop Campaign in a flexible manner to meet your marketing objectives.
- View up-to-date metrics kept by the BKS Network to Monitor Campaigns.

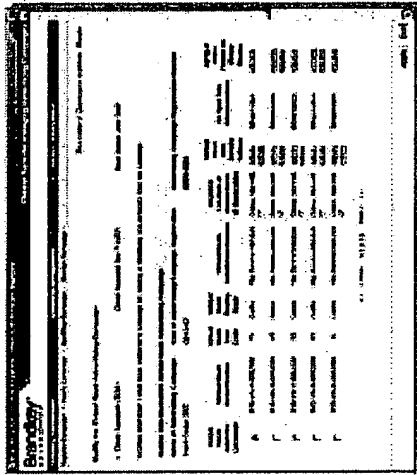

Click here to view larger screen

Fig. 54 V

1037/1046

Control Panel for Managing Advertising Campaigns



- Directory Management
- Campaign Management
- Ad-Spot Management
- Register Campaign
- Modify Campaign
- Run/Stop Campaign
- Monitor Campaign

Operational Mode

Modify the Virtual Kiosk Advertising Campaign

Client Account: Client Account 1 Client Account No: BKS-CA-A-0002003 User Name: John Smith

You may Modify the Virtual Kiosk Advertising Campaign by Adding or Removing Virtual Kiosks from the Campaign.

Master Data Record for Virtual Kiosk Advertising Campaign		
Name of Advertising Campaign	Date of Advertising Campaign Registration	Advertising Campaign Registration Number
Advertising Campaign 1	02-03-02	BKS-AC-A-0002007

Virtual Kiosk Added to Campaign	Virtual Kiosk Serial Number	Virtual Kiosk Type Code	Virtual Kiosk Display Mode	Virtual Kiosk Installation Domain	Physical Location of Virtual Kiosk (if Applicable)	Virtual Kiosk User Activity Indices	Ad Spot Rate (\$/Impression)	Ad Spot Order Placed on Virtual Kiosks
<input checked="" type="checkbox"/>	BKS-VK-A-0002003	PS	Tri-Mode	http://www.sponsor1.com	NA	activity indices	\$/Impression	ASO#26
<input type="checkbox"/>	BKS-VK-A-0002004	VS	Dual-Mode	http://www.sponsor2.com	NA	activity indices	\$/Impression	ASO#29, ASO#32
<input type="checkbox"/>	BKS-VK-A-0002005	PS	Tri-Mode	http://www.sponsor1.com	NA	activity indices	\$/Impression	ASO#26
<input type="checkbox"/>	BKS-VK-A-0002006	PS	Tri-Mode	http://www.sponsor3.com	NA	activity indices	\$/Impression	ASO#29, ASO#32
<input type="checkbox"/>	BKS-VK-A-0002007	VS	Dual-Mode	http://www.sponsor1.com	NA	activity indices	\$/Impression	ASO#26

◀◀ | ◀ Back 1 2 3 4 5 Next ▶▶

[Click here to return to previous page](#)

Fig. 54W

1030/1046



- Brandkey Systems
- Brandkey Create
- Brandkey Deliver
- Brandkey Advertise
- Brandkey Promote

Manage Advertising Campaigns

- Place Ad-Spot Orders on installed networks of Multi-Mode Virtual Kiosks.
- Place Ad-Spot Order on installed networks of Multi-Mode Virtual Kiosks.
- Modify Ad-Spot Order placed on installed networks of Multi-Mode Virtual Kiosks.

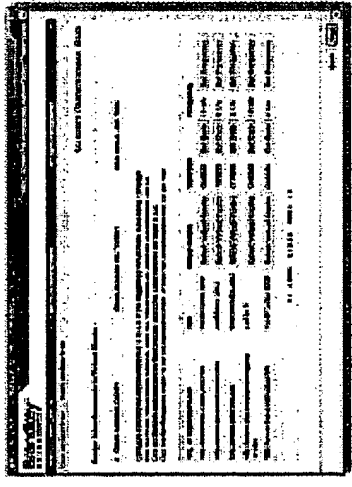

Click here to view larger screen

fig. 54X



Control Panel for Managing Advertising Campaigns

Directory Management

Campaign Management

Ad-Spot Management

Place Ad-Spot Order | Modify Ad-Spot Order

Operational Mode

Assign Advertisements to Virtual Kiosks

Client Account: Client Account 1 | Client Account No: BKS-CA-A-0002003 | User Name: John Smith

Configure selected advertisement(s) that is to run in the Registered Virtual Kiosk Advertising Campaign. Click the Select Virtual Kiosks button to select the Virtual Kiosks on which the Advertisement will run. Click the Set Date button to set the Start Date on which the Advertisement will begin to run. Click the Set Frequency button to set the maximum number of times the Advertisement may run per hour.

URL of Advertisement	Title	Virtual Kiosks	Start Date	Frequency
http://www.clientaccount1.com/content/ad1.mpg	Advertisement 1	Select Virtual Kiosks	09/20/02	10 X/hr Set Frequency
http://www.clientaccount1.com/content/ad2.mpg	Advertisement 2	Select Virtual Kiosks	10/30/02	5 X/hr Set Frequency
http://www.clientaccount1.com/content/ad3.mpg	Advertisement 3	Select Virtual Kiosks	07/10/02	2 X/hr Set Frequency
http://www.clientaccount1.com/content/ad4.mpg	Advertisement 4	Select Virtual Kiosks	01/02/02	10 X/hr Set Frequency
http://www.clientaccount1.com/content/ad5.mpg	Advertisement 5	Select Virtual Kiosks	09/20/02	5 X/hr Set Frequency

Back 1 2 3 4 5 Next

Click here to return to previous page

FIG. 54Y

1039/1046

1040/1046

Promote

Branded Products and Services

Promote your branded products and services by building, running and managing Promotional Campaigns on Multi-Mode Virtual Kiosks delivered to Consumers.

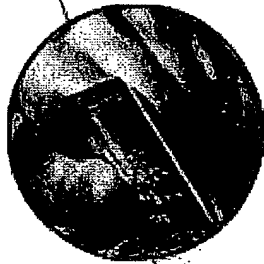
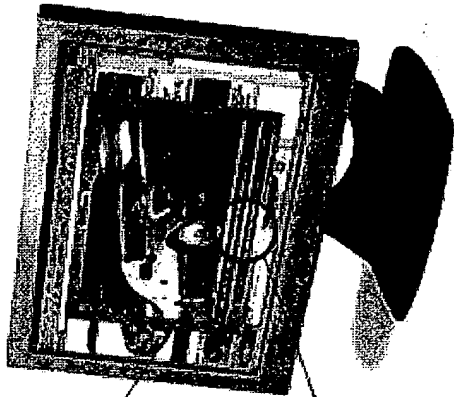

FIG. 547

1041/1046



- Brandkey Systems
- Brandkey Create
- Brandkey Deliver
- Brandkey Advertise
- Brandkey Promote

Manage Promotional Campaigns

Manage Promotional Campaigns to be run on networks of installed Multi-Mode Virtual Kiosks.

▼ Create Multi-Mode Virtual Kiosk Promotional Directories that specify on which Multi-Mode Virtual Kiosks you are permitted to run your Promotion Campaigns.

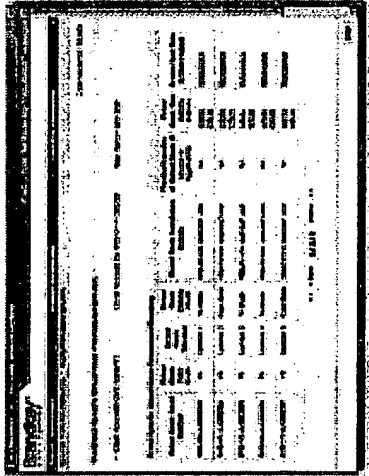

[Click here to view larger screen](#)

- Generate Promotional Directory identifying on which Multi-Mode Virtual Kiosks your Agents are permitted to run your Brand's Promotion Campaigns.
- Modify Promotional Directory that specify on which Multi-Mode Virtual Kiosks your Agents are permitted to run your Brand's Promotion Campaigns.

Fig. 54a9



Control Panel for Managing Promotional Campaigns

[Directory Management](#) |
 [Campaign Management](#) |
 [Promo-Spot Management](#) |
 [Generate Promotional Directory](#) |
 [Modify Promotional Directory](#)

Operational Mode

The Brand-Specific Virtual Kiosk Promotional Directory

Client Account: Client Account 1 Client Account No: BKS-CA-A-0002003 User Name: John Smith

Brand-Specific Virtual Kiosk Promotional Directory

Virtual Kiosk Serial Number	Virtual Kiosk Type Code	Virtual Kiosk Sponsor	Virtual Kiosk Display Mode	Virtual Kiosk Installation Domain	Physical Location of Virtual Kiosk (if known or Applicable)	Virtual Kiosk User Activity Indices	Promo Spot Rate (\$/Impression)
BKS-VK-A-0002003	PS	Sponsor 1	Tri-Mode	http://www.sponsor1.com	NA	activity indices	\$/Impression
BKS-VK-A-0002004	VS	Sponsor 2	Dual-Mode	http://www.sponsor2.com	NA	activity indices	\$/Impression
BKS-VK-A-0002005	PS	Sponsor 3	Tri-Mode	http://www.sponsor1.com	NA	activity indices	\$/Impression
BKS-VK-A-0002006	PS	Sponsor 4	Tri-Mode	http://www.sponsor3.com	NA	activity indices	\$/Impression
BKS-VK-A-0002007	VS	Sponsor 5	Dual-Mode	http://www.sponsor1.com	NA	activity indices	\$/Impression

◀◀ | ◀ Back 1 2 3 4 5 Next ▶▶

[Click here to return to previous page](#)

Fig. 5466

1042/1046

1043/1046

Back

Next

Manage Promotional Campaigns

▼ Register and Manage Promotional Campaigns to be run on specified Networks on Multi-Mode/Virtual Kiosks.

- Register Campaign to be run on specified Networks of Multi-Mode Virtual Kiosks.
- Flexibly add or delete Multi-Mode Virtual Kiosks at any time to Modify Campaigns.
- Stop Campaign in a flexible manner to meet your marketing objectives.
- View up-to-date metrics kept by the BKS Network to Monitor Campaigns.

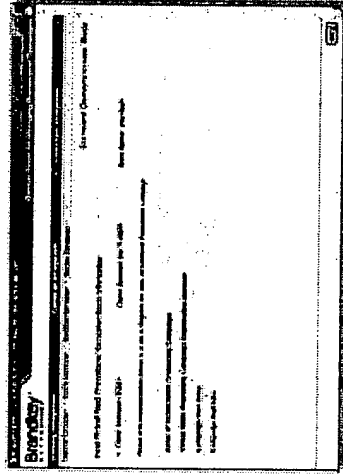

[Click here to view larger screen](#)

Fig. 54cc



Control Panel for Managing Promotional Campaigns

- Directory Management
- Campaign Management
- Promo-Spot Management
- Register Campaign
- Run/Stop Campaign
- Monitor Campaign
- Modify Campaign

Operational Mode

Input Virtual Kiosk Promotional Campaign Basic Information

Client Account: Client Account 1	Client Account No: BKS-CA-A-0002003	User Name: John Smith
----------------------------------	-------------------------------------	-----------------------

Please enter the information below in order to Register the new Virtual Kiosk Promotional Campaign.

Name of Virtual Kiosk Promoting Campaign:	<input type="text"/>
Virtual Kiosk Promoting Campaign Registration Number:	<input type="text"/>
Campaign Start Date:	<input type="text"/>
Campaign End Date:	<input type="text"/>

[Click here to return to previous page](#)

Fig. 54dd

1044/1046

Manage Promotional Campaigns

▼ Place Promo-Spot Orders on installed networks of Multi-Mode Virtual Kiosks.

▪ Place Promo-Spot Order on installed networks of Multi-Mode Virtual Kiosks.

▪ Modify Promo-Spot Order placed on installed networks of Multi-Mode Virtual Kiosks.

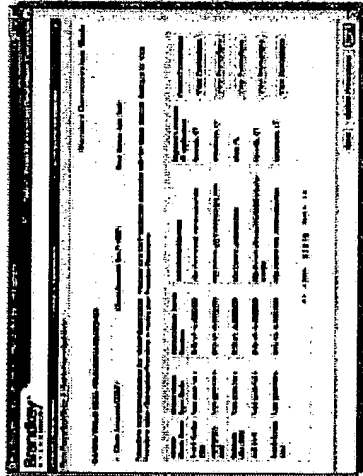

[Click here to view larger screen](#)

Fig. 54ee



Control Panel for Managing Promotional Campaigns

Directory Management

Campaign Management

Promo-Spot Management

Place Promo-Spot Order

Modify Promo-Spot Order

Operational Mode

Confirm Virtual Kiosk Promotional-Spot Order

Client Account: Client Account 1 Client Account No: BKS-CA-A-0002003 User Name: John Smith

Promotions have been placed on the Virtual Kiosks below. You may view the Promotion(s) associated with the Virtual Kiosk by clicking on its View Promotions button. Click Update Promotions to modify your Promotion Placements.

Virtual Kiosk Name	Virtual Kiosk Code	Virtual Kiosk Type	Virtual Kiosk Serial Number	Installation Domain	Physical Location (if applicable)	Placed Promotions
Virtual Kiosk 1		PS	BKS-VK-A-0002003	http://www.sponsor1.com	NA	View Promotions
Virtual Kiosk 2		VS	BKS-VK-A-0002004	http://www.sponsor2.com	NA	View Promotions
Virtual Kiosk 3		PS	BKS-VK-A-0002005	http://www.sponsor1.com	NA	View Promotions
Virtual Kiosk 4		PS	BKS-VK-A-0002006	http://www.sponsor3.com	NA	View Promotions
Virtual Kiosk 5		VS	BKS-VK-A-0002007	http://www.sponsor2.com	NA	View Promotions

◀◀ | ◀ Back 1 2 3 4 5 Next ▶▶▶▶

[Click here to return to previous page](#)

Fig. 54ff

1046/1046